

Electro-Static Discharge for Automobile AUSD03FB Low Capacitance TVS Diode

SOD-323

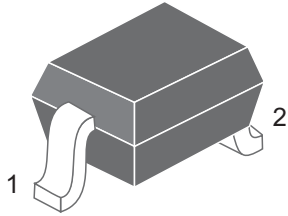

Pin Configuration

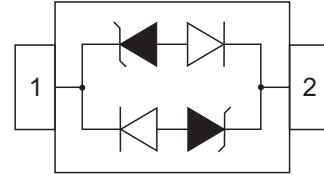

Features

- 350 Watts Peak Pulse Power per Line ($t_p=8/20\mu s$)
- Protects one I/O or power line (bidirectional)
- Low clamping voltage
- Working voltages: 3.3V
- Low leakage current
- AEC-Q101

IEC Compatibility

- IEC61000-4-2 (ESD) $\pm 30kV$ (air), $\pm 30kV$ (contact)
- IEC61000-4-4 (EFT) 40A (5/50ns)

Applications

- Cell Phone Handsets and Accessories
- Microprocessor based equipment
- Personal Digital Assistants(PDA's)
- Notebooks,Desktops,and Servers
- Portable Instrumentation
- Peripherals
- USB Interface

Mechanical Characteristics

- JEDEC SOD-323 Package
- Molding Compound Flammability Rating:UL 94V-O
- Weight 5 Millgrams(Approximate)
- Quantity Per Reel:3000pcs
- Reel Size:7 inch
- Lead Finish:Lead Free

Maximum Ratings($T_A=25^{\circ}\text{C}$ unless otherwise noted)

Parameter	Symbol	Value	Units
Peak Pulse Power($t_p=8/20\mu\text{s}$)	P_{PP}	350	Watts
Lead Soldering Temperature	T_L	260(10 sec.)	$^{\circ}\text{C}$
Operating Temperature Range	T_J	-55~150	$^{\circ}\text{C}$
Storage Temperature Range	T_{STG}	-55~150	$^{\circ}\text{C}$

Electrical Characteristics($T_A=25^{\circ}\text{C}$ unless otherwise specified)

AUSD03FB(Marking:CC)

Parameter	Symbol	Conditions	Min.	Max.	Units
Reverse Stand-off Voltage	V_{RWM}			3.3	V
Breakdown Voltage	V_{BR}	$I_T=1\text{mA}$	4		V
Clamping Voltage	V_C	$I_{PP}=1\text{A}, t_p=8/20\mu\text{s}$		7.5	V
		$I_{PP}=8\text{A}, t_p=8/20\mu\text{s}$		13.9	V
Reverse Leakage Current	I_R	@ V_{RWM}		20	μA
Junction Capacitance	$C_{I/O}$	0Vdc, $f=1\text{MHz}$ Between I/O Pins and GND		1.5	pF

Ratings and Characteristic Curves

Fig.1 Pulse Waveform

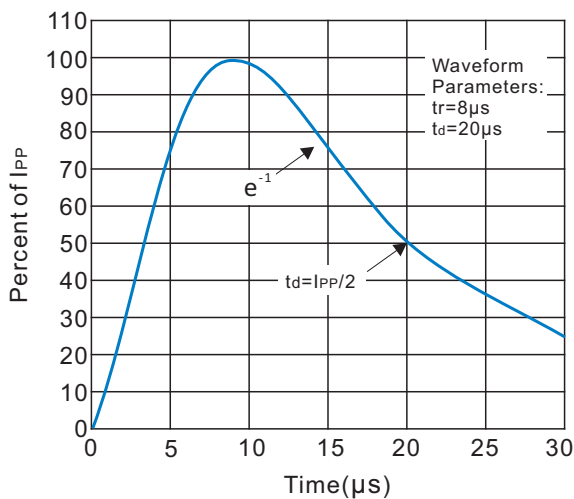
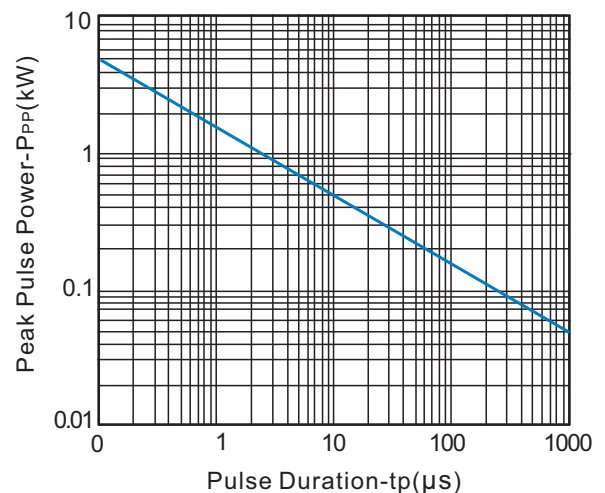
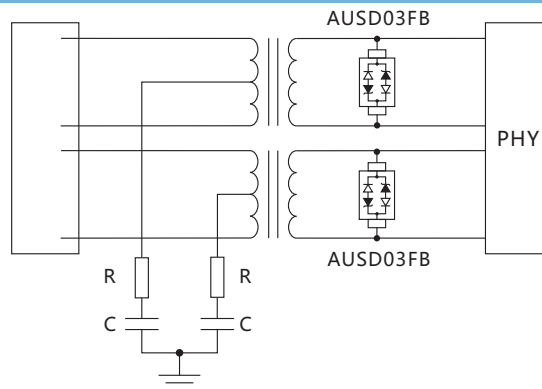

Fig.2 Non-Repetitive Pulse Power vs.Pulse Time



Application Information

RJ45 Protection



PCB Layout Recommendations

The location and circuit board layout is critical to maximize the effectiveness of the RJ45 protection circuit. The following guidelines are recommended:

- Locate the protection devices as close as possible to the RJ45 connector. This allows the protection devices to absorb the energy of the transient voltage before it can be coupled into the adjacent traces on the PCB.
- Minimize the loop area for the high-speed data lines, power and ground lines to reduce the radiated emissions.
- Avoid running protection conductors in parallel with unprotected conductors
- Use ground planes wherever possible to reduce the parasitic capacitance and inductance of the PCB that degrades the effectiveness of a filter device.
- Using shared transient return paths to a common ground point.

Dimensions(SOD-323)

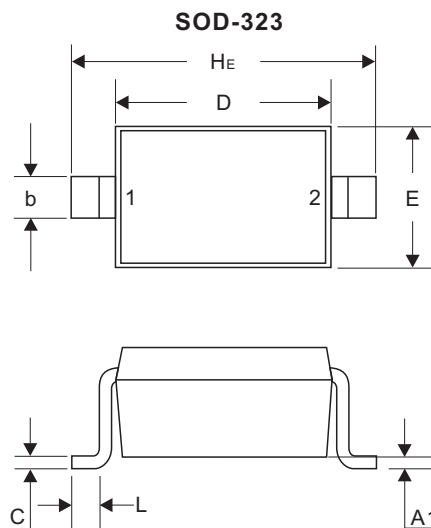

DIM	Millimeters		Inches	
	Min	Max	Min	Max
A	0.80	1.00	0.031	0.040
A1	0.00	0.10	0.000	0.004
A3	0.15REF		0.006REF	
b	0.25	0.40	0.010	0.016
C	0.089	0.177	0.003	0.007
D	1.60	1.80	0.062	0.070
E	1.15	1.35	0.045	0.053
L	0.08		0.003	
H _E	2.30	2.70	0.090	0.105

Recommended Mounting Pad Layout

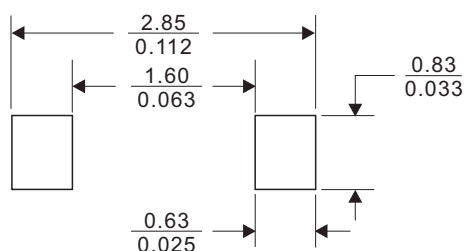

Dimensions in ($\frac{\text{millimeters}}{\text{inches}}$)