

Axial Lead Transient Voltage Suppressors (TVS)

SAC Series 5.0 To 50 V 500W Low Capacitance

Description

The SAC series is designed specifically to protect sensitive electronic equipment from voltage transients induced by lightning and other transient voltage events.

Features

- u Glass passivated chip
- u 500W peak pulse power capability with a 10/1000 μ s waveform, repetitive rate (duty cycle): 0.01%
- u Low leakage
- u Excellent clamping capability
- u Very fast response time
- u RoHS compliant

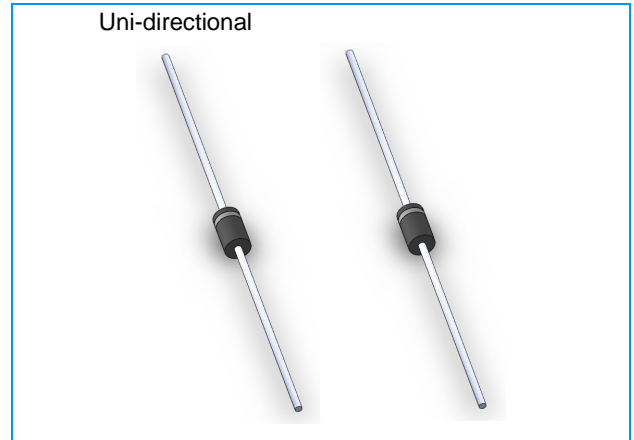

Applications

TVS devices are ideal for the protection of I/O interfaces, V_{CC} bus and other vulnerable circuits used in Telecom, Computer, Industrial and Consumer electronic applications.

Maximum Ratings ($T_A=25^\circ\text{C}$ unless otherwise noted)

Parameter	Symbol	Value	Unit
Peak Pulse Power Dissipation with a 10/1000 μ s waveform ⁽¹⁾	P_{PPM}	500	Watts
Peak Pulse Current with a 10/1000 μ s waveform.(Fig.2) ⁽¹⁾	I_{PP}	See Next Table	Amps
Power Dissipation on Infinite Heat Sink at $T_L=75^\circ\text{C}$ (Fig.2)	$P_{M(AV)}$	3.0	Watt
Operating junction and Storage Temperature Range	T_J, T_{STG}	-55 to +150	$^\circ\text{C}$

Notes:

1. Non-repetitive current pulse, per Fig. 3 and derated above $T_A=25^\circ\text{C}$ per Fig. 2

Electrical Characteristics ($T_A=25^\circ\text{C}$ unless otherwise noted)

Part Number	Reverse Stand-Off Voltage V_{RWM} (V)	Breakdown Voltage V_{BR} @ $I_T=1.0\text{mA}$ (V)	Maximum Reverse Leakage I_R @ V_{RWM} (μA)	Maximum Clamping Voltage V_C @ I_{PP} (V)	Maximum Peak Pulse Current I_{PP} (A)	Maximum Junction Capacitance @0V (pF)	Working Inverse Blocking Voltage V_{WIB} (V)	Inverse Blocking Leakage Current I_B @ V_{WIB} (mA)	Peak Inverse Voltage V_{PIB} (V)
		MIN							
SAC5.0	5.0	7.60	300	10.0	44.0	50	75	1	100
SAC6.0	6.0	7.90	300	11.2	41.0	50	75	1	100
SAC7.0	7.0	8.33	300	12.6	38.0	50	75	1	100
SAC8.0	8.0	8.89	100	13.4	36.0	50	75	1	100
SAC8.5	8.5	9.44	50	14.0	34.0	50	75	1	100
SAC10	10.0	11.10	5	16.3	29.0	50	75	1	100
SAC12	12.0	13.30	5	19.0	25.0	50	75	1	100
SAC15	15.0	16.67	5	23.6	20.0	50	75	1	100
SAC18	18.0	20.00	5	28.8	15.0	50	75	1	100
SAC22	22.0	24.40	5	35.4	14.0	50	75	1	100
SAC26	26.0	28.90	5	42.3	11.1	50	75	1	100
SAC30	30.0	33.30	5	48.6	10.0	50	75	1	100
SAC36	36.0	40.00	5	60.0	8.6	50	75	1	100
SAC45	45.0	50.00	5	77.0	6.8	50	150	1	200
SAC50	50.0	55.50	5	88.0	5.8	50	150	1	200

Axial Lead Transient Voltage Suppressors (TVS)

SAC Series 5.0 To 50 V 500W Low Capacitance

Ratings and Characteristic Curves ($T_A=25^\circ\text{C}$ unless otherwise noted)

Figure 1 - Peak Pulse Power Rating Curve

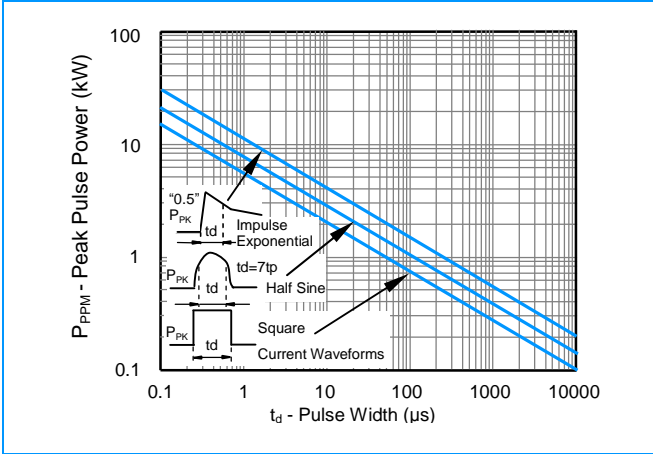

Figure 2 - Pulse Derating Curve

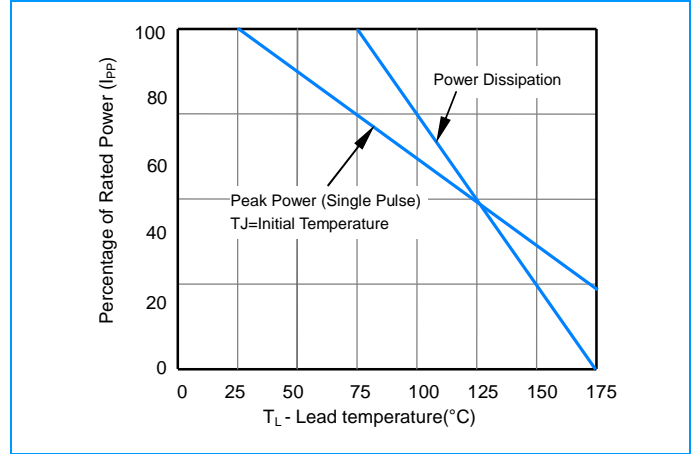

Figure 3 - Pulse Waveform

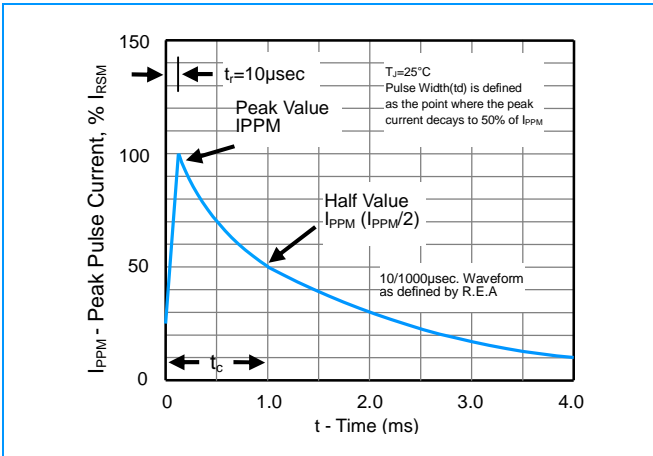
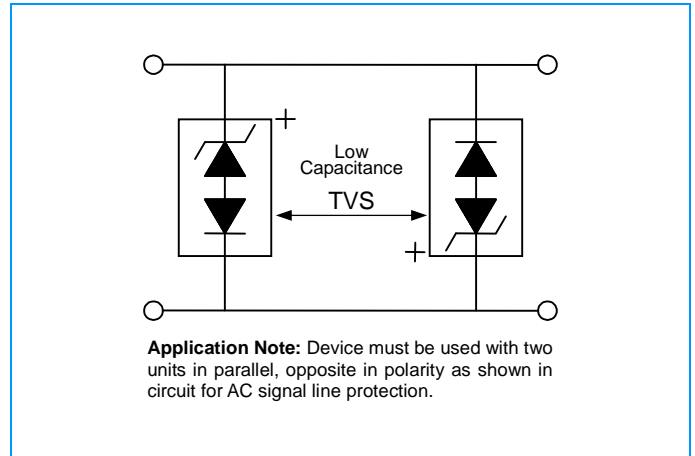

Figure 4 - AC Line Protection Application



Axial Lead Transient Voltage Suppressors (TVS)

SAC Series 5.0 To 50 V 500W Low Capacitance

Physical Specifications

Weight	0.015 ounce, 0.4 gram
Case	JEDEC DO-204AC (DO-15) Molded Plastic over glass passivated junction
Polarity	Color band denotes cathode except Bipolar
Terminal	Matte Tin-plated leads, Solderable per JESD22-B102D

Environmental Specifications

Temperature Cycle	JESD22-A104
Pressure Cooker	JESD22-A102
High Temp. Storage	JESD22-A103
HTRB	JESD22-A108
Thermal Shock	JESD22-A106

Soldering Parameters

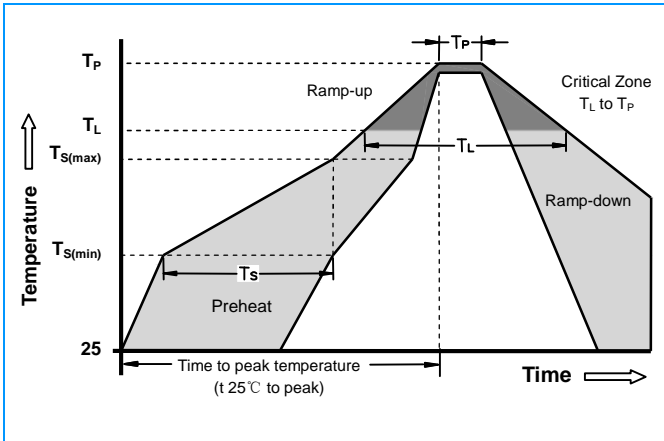

Reflow Condition		Lead-free assembly
Pre Heat	-Temperature Min ($T_{s(min)}$)	150°C
	-Temperature Max ($T_{s(max)}$)	200°C
	- Time (min to max) (t_s)	60 - 180 Seconds
Average ramp up rate (Liquidus Temp T_L) to peak		3°C/second max
$T_{s(max)}$ to T_L - Ramp-up Rate		3°C/second max
Reflow	- Temperature (T_L) (Liquidus)	217°C
	- Time (min to max) (t_s)	60 - 150 Seconds
Peak Temperature (T_P)		260 +0/-5°C
Time within 5°C of actual peak Temperature (t_p)		20 - 40 Seconds
Ramp-down Rate		6°C/second max
Time 25°C to peak Temperature (T_P)		8 minutes Max
Do not exceed		280°C

Dimensions

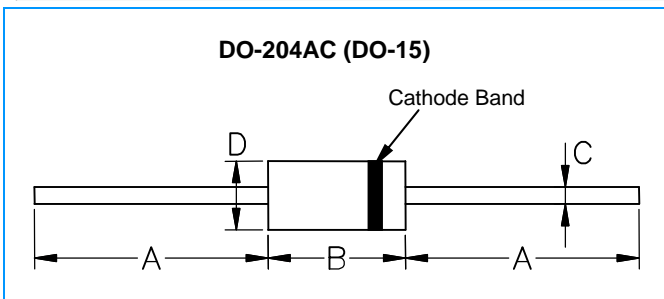

Dimensions	Inches		Millimeters	
	Min	Max	Min	Max
A	1.000	-	25.40	-
B	0.230	0.300	5.85	7.63
C	0.028	0.033	0.71	0.84
D	0.102	0.142	2.60	3.61