

Box Fan R87B

CSM_R87B_DS_E_4_3

Comprehensive Lineup of Single, Double, and Triple Axial Fans with Easy One-step Mounting

- Mounts in a square cutout and conceals the hole-cut to simplify installation work.
- Cover can be set to open either upward or downward for convenience in confined spaces.
- Enhanced accessories (finger guard, filter, plug cord, mounting screws).
- Optional Replacement Filter and Vent Attachment.
- The lineup includes Single, Double, and Triple Box Fans with eight models with plastic blades and eight models with metal blades.



 Refer to *Safety Precautions for All Axial Fans*.

Model Number Structure

Model Number Legend

R87B-□□□A15□PF□□
 1 2 3 4 5

Attachment

R87B-N□
 1 5

Options and Accessories

R87B-P□□□
 1 6 7

Number	Category	Symbol	Meaning of symbol
1	Fan (blade material)	F T N	R87F Axial Fan (with plastic blades) R87T Axial Fan (with metal blades) No fan
	Optional parts	P	Options and accessories
2	Power supply classification	A1	100 VAC
		A3	115 VAC
		A4	200 VAC
		A6	230 VAC
3	Speed classification	H	High speed
		M	Middle speed
		L	Low speed
4	Airflow direction *	None	In
		R	Out
5	Number of fans	None	1
		2	2
		3	3
6	Part type	F	Filter
7	Reference number	01	---

Note: These tables show only how to read model numbers. They do not indicate which products are available.

Refer to *"Ratings and Ordering Information"* when placing an order.

* "In" is the direction of external air flowing in.
 "Out" is the direction of internal air flowing out.

Ordering Information

Type	Number of fans	Model	Accessories
Plastic blades High speed	1	R87B-FA□A15HPF(R)	Filter Finger guard Plug cord Mounting bolts
	2	R87B-FA□A15HPF(R)2	
	3	R87B-FA□A15HPF(R)3	
Plastic blades Low speed	1	R87B-FA□A15LPPF(R)	
	2	R87B-FA□A15LPPF(R)2	
	3	R87B-FA□A15LPPF(R)3	
Metal blades High speed	1	R87B-TA□A15HPF(R)	
	2	R87B-TA□A15HPF(R)2	
	3	R87B-TA□A15HPF(R)3	
Metal blades Medium speed	1	R87B-TA□A15MPF(R)	
	2	R87B-TA□A15MPF(R)2	
	3	R87B-TA□A15MPF(R)3	
Attachment	For 1	R87B-N	Filter Finger guard Mounting screws
	For 2	R87B-N2	
	For 3	R87B-N3	
Replacement Filter	Any	R87B-PF01	Set of two filters

Ratings and Ordering Information

Item	Model	R87B-F	R87B-T
Motor type		Single-phase shading coil induction motor (2-pole, open type)	
Terminal type		Terminals	
Insulation class		IEC class B (130°C) UL class A (105°C) CSA class A (105°C)	IEC class B (130°C) UL class A (105°C)
Insulation resistance		100 MΩ min. (at 500 VDC) Between all power supply connection parts and non-current carrying metal parts	
Dielectric strength		2,000 VAC for 1 min Between all power supply connection parts and non-current carrying metal parts	
Ambient operating temperature		-30 to 70°C (with no icing)	-20 to 70°C (with no icing)
Storage temperature		-40 to 85°C (with no icing)	
Ambient humidity		25% to 85%	
Protection		Impedance protection	
Materials	Frame	Die-cast aluminum	
	Blades	Glass polycarbonate	Steel plate (black coating)
Bearings		Ball bearings	
Compliant standards*		PSE, EN/IEC 60335 (CE self-declaration)	
Certified standards*		UL/CSA	UL

Note: The rated current is the total for all fans.

* The compliant standards and certified standards apply to the listed Axial Fans.

Safety Precautions

Refer to *Safety Precautions for All Axial Fans*.

ALL DIMENSIONS SHOWN ARE IN MILLIMETERS.
To convert millimeters into inches, multiply by 0.03937. To convert grams into ounces, multiply by 0.03527.

In the interest of product improvement, specifications are subject to change without notice.

Ratings and Ordering Information

Airflow Direction: In

Item Model	Rated voltage (V)	Permitted voltage fluctuation range (%)	Frequency (Hz)	Rated rotational speed (r/min) *		Maximum flow rate (m ³ /min) *		Maximum static pressure (Pa) *		Noise (dB) *		Weight
				50 Hz	60 Hz	50 Hz	60 Hz	50 Hz	60 Hz	50 Hz	60 Hz	
R87B-FA1A15HPF	100	85% to 110% rated voltage	50/60	2,700	3,100	1.3	1.5	91	85	49	52	Approx. 1,120 g
R87B-FA3A15HPF	115											
R87B-FA4A15HPF	200											
R87B-FA6A15HPF	230											
R87B-FA1A15LPF	100	85% to 110% rated voltage	50/60	2,100	2,200	0.9	1.0	43	42	42	43	
R87B-FA3A15LPF	115											
R87B-FA4A15LPF	200											
R87B-FA6A15LPF	230											
R87B-TA1A15HPF	100	85% to 110% rated voltage	50/60	2,650	3,000	1.1	1.3	67	63	45	48	Approx. 1,150 g
R87B-TA3A15HPF	115											
R87B-TA4A15HPF	200											
R87B-TA6A15HPF	230											
R87B-TA1A15MPF	100	85% to 110% rated voltage	50/60	2,300	2,600	0.8	1.0	41	45	41	44	
R87B-TA3A15MPF	115											
R87B-TA4A15MPF	200											
R87B-TA6A15MPF	230											

Note: An asterisk (*) indicates a nominal value.

Airflow Direction: Out

Item Model	Rated voltage (V)	Permitted voltage fluctuation range (%)	Frequency (Hz)	Rated rotational speed (r/min) *		Maximum flow rate (m ³ /min) *		Maximum static pressure (Pa) *		Noise (dB) *		Weight
				50 Hz	60 Hz	50 Hz	60 Hz	50 Hz	60 Hz	50 Hz	60 Hz	
R87B-FA1A15HPFR	100	85% to 110% rated voltage	50/60	2,700	3,100	1.3	1.5	91	85	49	52	Approx. 1,120 g
R87B-FA3A15HPFR	115											
R87B-FA4A15HPFR	200											
R87B-FA6A15HPFR	230											
R87B-FA1A15LPFR	100	85% to 110% rated voltage	50/60	2,100	2,200	0.9	1.0	43	42	42	43	
R87B-FA3A15LPFR	115											
R87B-FA4A15LPFR	200											
R87B-FA6A15LPFR	230											
R87B-TA1A15HPFR	100	85% to 110% rated voltage	50/60	2,650	3,000	1.1	1.3	67	63	45	48	Approx. 1,150 g
R87B-TA3A15HPFR	115											
R87B-TA4A15HPFR	200											
R87B-TA6A15HPFR	230											
R87B-TA1A15MPFR	100	85% to 110% rated voltage	50/60	2,300	2,600	0.8	1.0	41	45	41	44	
R87B-TA3A15MPFR	115											
R87B-TA4A15MPFR	200											
R87B-TA6A15MPFR	230											

Note: An asterisk (*) indicates a nominal value.

- The data in this table comes from measurements that were taken with the filter and cover attached.
- The model number of the AC Axial Fan in the Box Fan can be determined from the model number of the Box Fan as follows:

R87B-FA1A15HPF→R87F-A1A15HP

The model number of the Axial Fan can be determined by extracting the underlined portions from the model number of the Box Fan as shown.

Dimensions

(Unit: mm)

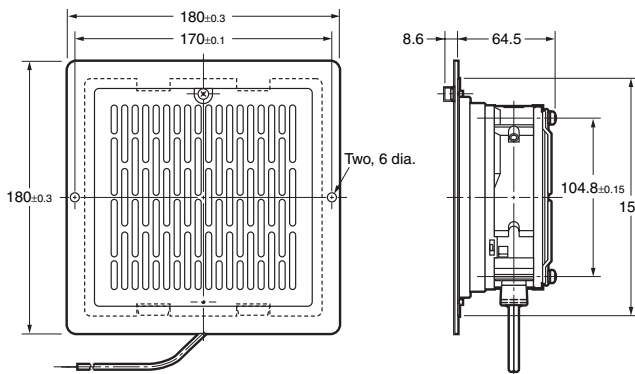

Panel Cutout Dimensions

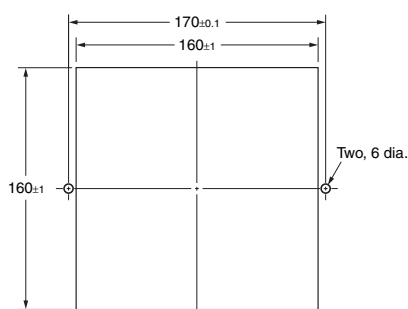

ALL DIMENSIONS SHOWN ARE IN MILLIMETERS.
 To convert millimeters into inches, multiply by 0.03937. To convert grams into ounces, multiply by 0.03527.

In the interest of product improvement, specifications are subject to change without notice.

Double Box Fan

R87B-□A□A15□PF(R)2

Ratings and Ordering Information

Airflow Direction: In

Item Model	Rated voltage (V)	Permitted voltage fluctuation range (%)	Frequency (Hz)	Rated rotational speed (r/min) *		Maximum flow rate (m ³ /min) *		Maximum static pressure (Pa) *		Noise (dB) *		Weight
				50 Hz	60 Hz	50 Hz	60 Hz	50 Hz	60 Hz	50 Hz	60 Hz	
R87B-FA1A15HPPF2	100	85% to 110% rated voltage	50/60	2,700	3,100	2.6	3.0	86	48	55	56	Approx. 2,220 g
R87B-FA3A15HPPF2	115											
R87B-FA4A15HPPF2	200											
R87B-FA6A15HPPF2	230											
R87B-FA1A15LPPF2	100	85% to 110% rated voltage	50/60	2,100	2,200	2.0	2.1	47	44	45	46	
R87B-FA3A15LPPF2	115											
R87B-FA4A15LPPF2	200											
R87B-FA6A15LPPF2	230											
R87B-TA1A15HPPF2	100	85% to 110% rated voltage	50/60	2,650	3,000	2.4	2.7	68	63	49	52	Approx. 2,260 g
R87B-TA3A15HPPF2	115											
R87B-TA4A15HPPF2	200											
R87B-TA6A15HPPF2	230											
R87B-TA1A15MPF2	100	85% to 110% rated voltage	50/60	2,300	2,600	1.6	1.9	41	43	44	47	
R87B-TA3A15MPF2	115											
R87B-TA4A15MPF2	200											
R87B-TA6A15MPF2	230											

Note: An asterisk (*) indicates a nominal value.

Airflow Direction: Out

Item Model	Rated voltage (V)	Permitted voltage fluctuation range (%)	Frequency (Hz)	Rated rotational speed (r/min) *		Maximum flow rate (m ³ /min) *		Maximum static pressure (Pa) *		Noise (dB) *		Weight
				50 Hz	60 Hz	50 Hz	60 Hz	50 Hz	60 Hz	50 Hz	60 Hz	
R87B-FA1A15HPFR2	100	85% to 110% rated voltage	50/60	2,700	3,100	2.6	3.0	86	48	55	56	Approx. 2,220 g
R87B-FA3A15HPFR2	115											
R87B-FA4A15HPFR2	200											
R87B-FA6A15HPFR2	230											
R87B-FA1A15LPFR2	100	85% to 110% rated voltage	50/60	2,100	2,200	2.0	2.1	47	44	45	46	
R87B-FA3A15LPFR2	115											
R87B-FA4A15LPFR2	200											
R87B-FA6A15LPFR2	230											
R87B-TA1A15HPFR2	100	85% to 110% rated voltage	50/60	2,650	3,000	2.4	2.7	68	63	49	52	Approx. 2,260 g
R87B-TA3A15HPFR2	115											
R87B-TA4A15HPFR2	200											
R87B-TA6A15HPFR2	230											
R87B-TA1A15MPFR2	100	85% to 110% rated voltage	50/60	2,300	2,600	1.6	1.9	41	43	44	47	
R87B-TA3A15MPFR2	115											
R87B-TA4A15MPFR2	200											
R87B-TA6A15MPFR2	230											

Note: An asterisk (*) indicates a nominal value.

- The data in this table comes from measurements that were taken with the filter and cover attached.
- The model number of the AC Axial Fan in the Box Fan can be determined from the model number of the Box Fan as follows:

R87B-FA1A15HPF→R87F-A1A15HP

The model number of the Axial Fan can be determined by extracting the underlined portions from the model number of the Box Fan as shown.

Dimensions

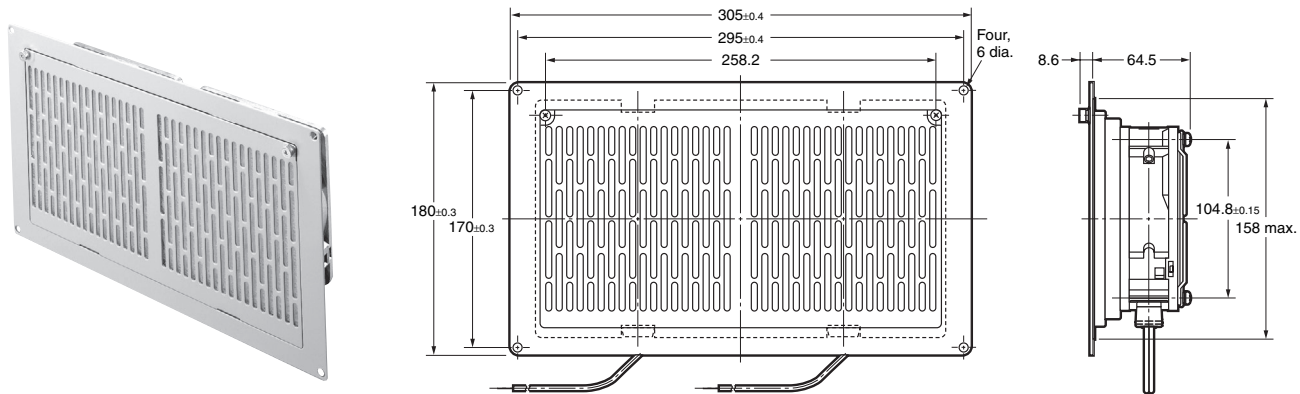

Panel Cutout Dimensions

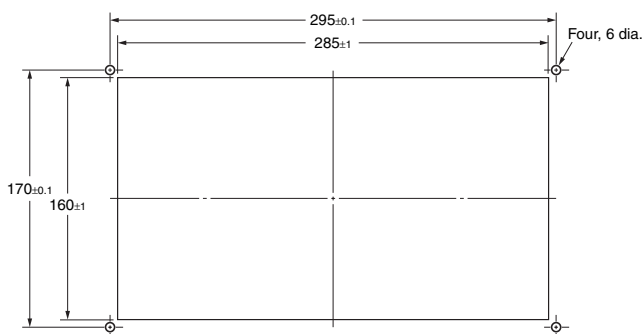

ALL DIMENSIONS SHOWN ARE IN MILLIMETERS.
 To convert millimeters into inches, multiply by 0.03937. To convert grams into ounces, multiply by 0.03527.

In the interest of product improvement, specifications are subject to change without notice.

Ratings and Ordering Information

Airflow Direction: In

Item Model	Rated voltage (V)	Permitted voltage fluctuation range (%)	Frequency (Hz)	Rated rotational speed (r/min) *		Maximum flow rate (m ³ /min) *		Maximum static pressure (Pa) *		Noise (dB) *		Weight
				50 Hz	60 Hz	50 Hz	60 Hz	50 Hz	60 Hz	50 Hz	60 Hz	
R87B-FA1A15HPF3	100	85% to 110% rated voltage	50/60	2,700	3,100	3.9	4.5	86	56	56	58	Approx. 3,380 g
R87B-FA3A15HPF3	115											
R87B-FA4A15HPF3	200											
R87B-FA6A15HPF3	230											
R87B-FA1A15LPF3	100	85% to 110% rated voltage	50/60	2,100	2,200	2.9	3.1	42	41	47	48	
R87B-FA3A15LPF3	115											
R87B-FA4A15LPF3	200											
R87B-FA6A15LPF3	230											
R87B-TA1A15HPF3	100	85% to 110% rated voltage	50/60	2,650	3,000	3.5	4.0	68	63	50	53	Approx. 3,410 g
R87B-TA3A15HPF3	115											
R87B-TA4A15HPF3	200											
R87B-TA6A15HPF3	230											
R87B-TA1A15MPF3	100	85% to 110% rated voltage	50/60	2,300	2,600	2.4	2.8	41	45	45	48	
R87B-TA3A15MPF3	115											
R87B-TA4A15MPF3	200											
R87B-TA6A15MPF3	230											

Note: An asterisk (*) indicates a nominal value.

Airflow Direction: Out

Item Model	Rated voltage (V)	Permitted voltage fluctuation range (%)	Frequency (Hz)	Rated rotational speed (r/min) *		Maximum flow rate (m ³ /min) *		Maximum static pressure (Pa) *		Noise (dB) *		Weight
				50 Hz	60 Hz	50 Hz	60 Hz	50 Hz	60 Hz	50 Hz	60 Hz	
R87B-FA1A15HPFR3	100	85% to 110% rated voltage	50/60	2,700	3,100	3.9	4.5	86	56	56	58	Approx. 3,380 g
R87B-FA3A15HPFR3	115											
R87B-FA4A15HPFR3	200											
R87B-FA6A15HPFR3	230											
R87B-FA1A15LPFR3	100	85% to 110% rated voltage	50/60	2,100	2,200	2.9	3.1	42	41	47	48	
R87B-FA3A15LPFR3	115											
R87B-FA4A15LPFR3	200											
R87B-FA6A15LPFR3	230											
R87B-TA1A15HPFR3	100	85% to 110% rated voltage	50/60	2,650	3,000	3.5	4.0	68	63	50	53	Approx. 3,410 g
R87B-TA3A15HPFR3	115											
R87B-TA4A15HPFR3	200											
R87B-TA6A15HPFR3	230											
R87B-TA1A15MPFR3	100	85% to 110% rated voltage	50/60	2,300	2,600	2.4	2.8	41	45	45	48	
R87B-TA3A15MPFR3	115											
R87B-TA4A15MPFR3	200											
R87B-TA6A15MPFR3	230											

Note: An asterisk (*) indicates a nominal value.

- The data in this table comes from measurements that were taken with the filter and cover attached.
- The model number of the AC Axial Fan in the Box Fan can be determined from the model number of the Box Fan as follows:

R87B-FA1A15HPF → R87F-A1A15HP

The model number of the Axial Fan can be determined by extracting the underlined portions from the model number of the Box Fan as shown.

Dimensions

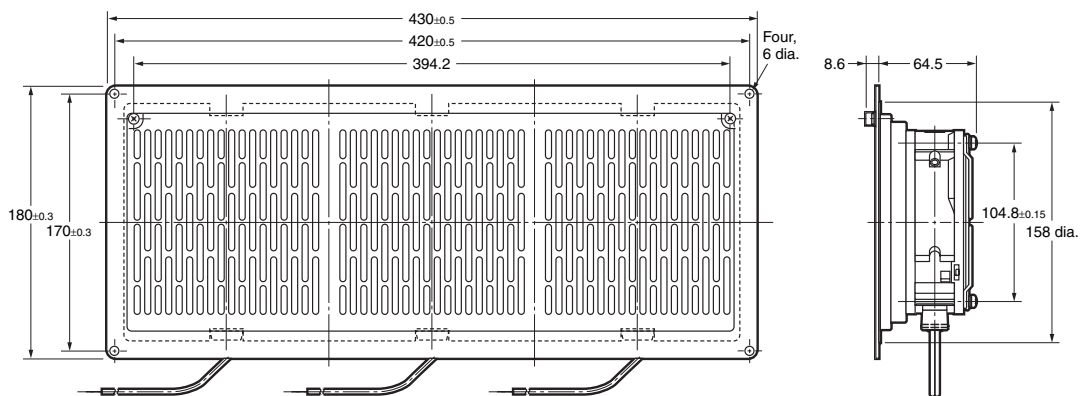
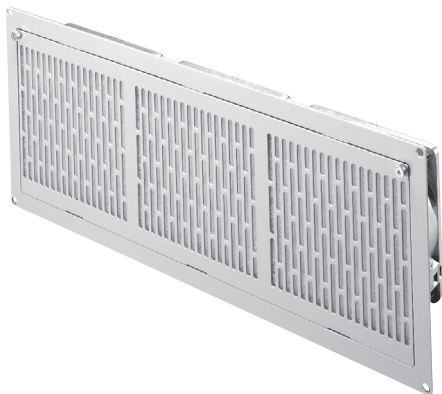

Panel Cutout Dimensions

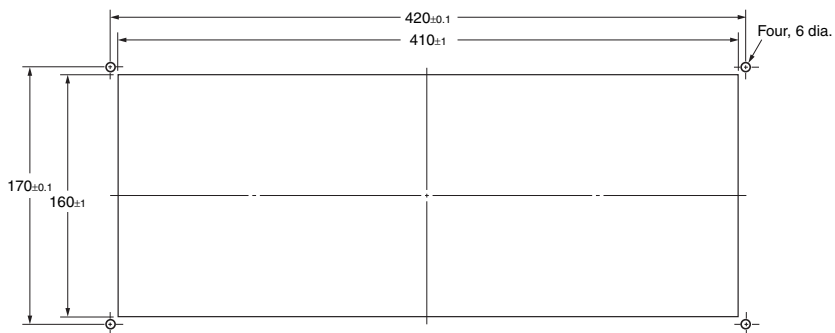

ALL DIMENSIONS SHOWN ARE IN MILLIMETERS.
 To convert millimeters into inches, multiply by 0.03937. To convert grams into ounces, multiply by 0.03527.

In the interest of product improvement, specifications are subject to change without notice.

R87B-N□/R87B-PF

R87B-N□ (Attachment)

Single Box

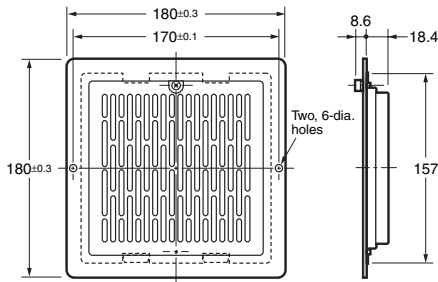

Triple Box

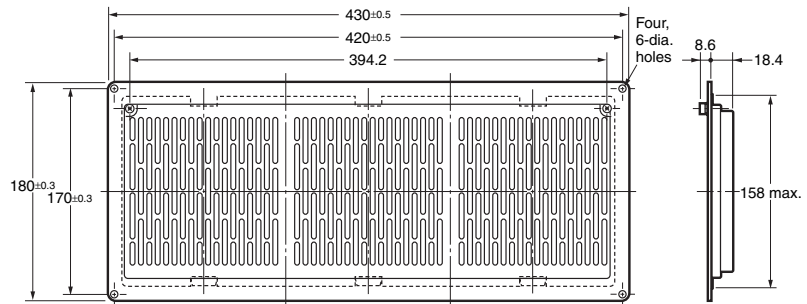

Double Box

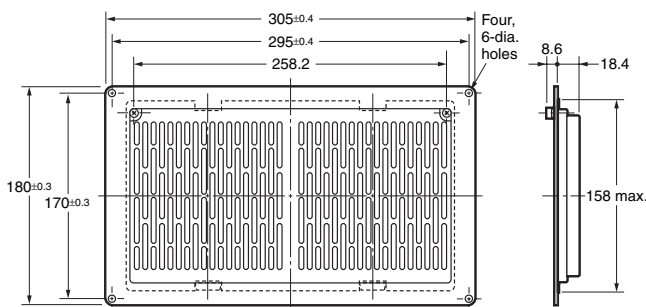

Ratings and Ordering Information

Model	Item	Type	Weight
R87B-N		Single	Approx. 570 g
R87B-N2		Double	Approx. 1,100 g
R87B-N3		Triple	Approx. 1,700 g

Note: The panel cut-out dimensions are the same as those for the Box Fan.

R87B-PF01 (Replacement Filter)

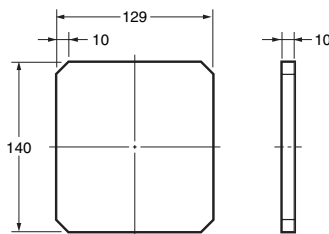

Ratings and Ordering Information

Model	Item	Qty.	Weight (grams per filter)
R87B-PF01		2	6

Filter Performance

Heat resistance (°C)	Filtration wind velocity (m/s)	Pressure drop (Pa)		Dust removal (%)	Dust suction amount (g/mm ²)
		Initial	Final		
100	2.5	49	70	70 min.	300

- Pay careful attention to clogging in the filter. A clogged filter will prevent the Fan from providing a cooling effect.

Replacing the Filter

1. Turn OFF the power, wait approximately one minute, and then open the cover. Remove the filter, replace it with a new filter, close the cover, and then firmly tighten the handle screw. This completes the filter replacement.
2. As a general guide to the replacement frequency, check the color of the filter regularly and replace it when the color shows a noticeable change.
3. It is recommended that the filter be replaced soon after the color changes noticeably in order to maintain the Fan's performance. (Replacement Filter: R87B-PF01)

Accessories

Model	Item	Mounting bolts (M4)	Hexagonal nuts (M4)	Plain washers	Spring washers	Cable with plug	Finger Guard (See note.)	Filter (See note.)
R87B-□A□A1□□PF(R)	(Single, with fan)	2	2	4	2	1	2	1
R87B-□A□A1□□PF(R)2	(Double, with fan)	4	4	8	4	2	4	2
R87B-□A□A1□□PF(R)3	(Triple, with fan)	4	4	8	4	3	6	3
R87B-N	(Single, without fan)	2	2	4	2	None	1	1
R87B-N2	(Double, without fan)	4	4	8	4	None	2	2
R87B-N3	(Triple, without fan)	4	4	8	4	None	3	3

Note: The Finger Guard and Filter are to be assembled into the Box Fan.

ALL DIMENSIONS SHOWN ARE IN MILLIMETERS.

To convert millimeters into inches, multiply by 0.03937. To convert grams into ounces, multiply by 0.03527.

In the interest of product improvement, specifications are subject to change without notice.

Terms and Conditions Agreement

Read and understand this catalog.

Please read and understand this catalog before purchasing the products. Please consult your OMRON representative if you have any questions or comments.

Warranties.

(a) Exclusive Warranty. Omron's exclusive warranty is that the Products will be free from defects in materials and workmanship for a period of twelve months from the date of sale by Omron (or such other period expressed in writing by Omron). Omron disclaims all other warranties, express or implied.

(b) Limitations. OMRON MAKES NO WARRANTY OR REPRESENTATION, EXPRESS OR IMPLIED, ABOUT NON-INFRINGEMENT, MERCHANTABILITY OR FITNESS FOR A PARTICULAR PURPOSE OF THE PRODUCTS. BUYER ACKNOWLEDGES THAT IT ALONE HAS DETERMINED THAT THE PRODUCTS WILL SUITABLY MEET THE REQUIREMENTS OF THEIR INTENDED USE.

Omron further disclaims all warranties and responsibility of any type for claims or expenses based on infringement by the Products or otherwise of any intellectual property right. (c) Buyer Remedy. Omron's sole obligation hereunder shall be, at Omron's election, to (i) replace (in the form originally shipped with Buyer responsible for labor charges for removal or replacement thereof) the non-complying Product, (ii) repair the non-complying Product, or (iii) repay or credit Buyer an amount equal to the purchase price of the non-complying Product; provided that in no event shall Omron be responsible for warranty, repair, indemnity or any other claims or expenses regarding the Products unless Omron's analysis confirms that the Products were properly handled, stored, installed and maintained and not subject to contamination, abuse, misuse or inappropriate modification. Return of any Products by Buyer must be approved in writing by Omron before shipment. Omron Companies shall not be liable for the suitability or unsuitability or the results from the use of Products in combination with any electrical or electronic components, circuits, system assemblies or any other materials or substances or environments. Any advice, recommendations or information given orally or in writing, are not to be construed as an amendment or addition to the above warranty.

See <http://www.omron.com/global/> or contact your Omron representative for published information.

Limitation on Liability; Etc.

OMRON COMPANIES SHALL NOT BE LIABLE FOR SPECIAL, INDIRECT, INCIDENTAL, OR CONSEQUENTIAL DAMAGES, LOSS OF PROFITS OR PRODUCTION OR COMMERCIAL LOSS IN ANY WAY CONNECTED WITH THE PRODUCTS, WHETHER SUCH CLAIM IS BASED IN CONTRACT, WARRANTY, NEGLIGENCE OR STRICT LIABILITY.

Further, in no event shall liability of Omron Companies exceed the individual price of the Product on which liability is asserted.

Suitability of Use.

Omron Companies shall not be responsible for conformity with any standards, codes or regulations which apply to the combination of the Product in the Buyer's application or use of the Product. At Buyer's request, Omron will provide applicable third party certification documents identifying ratings and limitations of use which apply to the Product. This information by itself is not sufficient for a complete determination of the suitability of the Product in combination with the end product, machine, system, or other application or use. Buyer shall be solely responsible for determining appropriateness of the particular Product with respect to Buyer's application, product or system. Buyer shall take application responsibility in all cases.

NEVER USE THE PRODUCT FOR AN APPLICATION INVOLVING SERIOUS RISK TO LIFE OR PROPERTY OR IN LARGE QUANTITIES WITHOUT ENSURING THAT THE SYSTEM AS A WHOLE HAS BEEN DESIGNED TO ADDRESS THE RISKS, AND THAT THE OMRON PRODUCT(S) IS PROPERLY RATED AND INSTALLED FOR THE INTENDED USE WITHIN THE OVERALL EQUIPMENT OR SYSTEM.

Programmable Products.

Omron Companies shall not be responsible for the user's programming of a programmable Product, or any consequence thereof.

Performance Data.

Data presented in Omron Company websites, catalogs and other materials is provided as a guide for the user in determining suitability and does not constitute a warranty. It may represent the result of Omron's test conditions, and the user must correlate it to actual application requirements. Actual performance is subject to the Omron's Warranty and Limitations of Liability.

Change in Specifications.

Product specifications and accessories may be changed at any time based on improvements and other reasons. It is our practice to change part numbers when published ratings or features are changed, or when significant construction changes are made. However, some specifications of the Product may be changed without any notice. When in doubt, special part numbers may be assigned to fix or establish key specifications for your application. Please consult with your Omron's representative at any time to confirm actual specifications of purchased Product.

Errors and Omissions.

Information presented by Omron Companies has been checked and is believed to be accurate; however, no responsibility is assumed for clerical, typographical or proofreading errors or omissions.