



# RF Power LDMOS Transistors

## N-Channel Enhancement-Mode Lateral MOSFETs

These 63 watt asymmetrical Doherty RF power LDMOS transistors are designed for cellular base station applications requiring very wide instantaneous bandwidth capability covering the frequency range of 2110 to 2170 MHz.

- Typical Doherty Single-Carrier W-CDMA Performance:  $V_{DD} = 28$  Volts,  $I_{DQA} = 750$  mA,  $V_{GSB} = 0.7$  Vdc,  $P_{out} = 63$  Watts Avg., Input Signal PAR = 9.9 dB @ 0.01% Probability on CCDF.

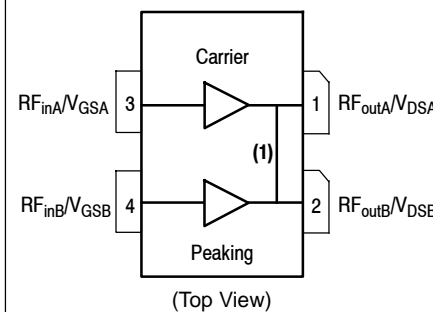
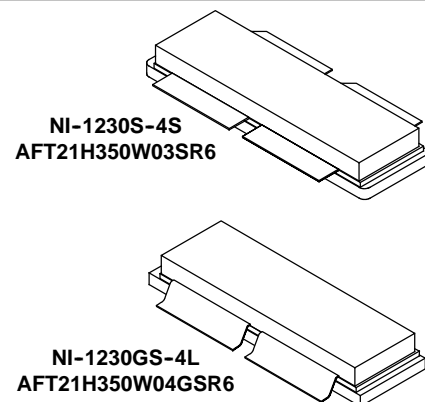
Frequency	$G_{ps}$ (dB)	$\eta_D$ (%)	Output PAR (dB)	ACPR (dBc)
2110 MHz	16.4	47.1	7.5	-26.0
2140 MHz	16.5	46.3	7.5	-27.9
2170 MHz	16.5	45.2	7.4	-30.1

### Features

- Advanced High Performance In-Package Doherty
- Designed for Wide Instantaneous Bandwidth Applications
- Greater Negative Gate-Source Voltage Range for Improved Class C Operation
- Designed for Digital Predistortion Error Correction Systems
- In Tape and Reel. R6 Suffix = 150 Units, 56 mm Tape Width, 13-inch Reel.

**AFT21H350W03SR6**  
**AFT21H350W04GSR6**

**2110–2170 MHz, 63 W AVG., 28 V**  
**AIRFAST RF POWER LDMOS**  
**TRANSISTORS**



**Figure 1. Pin Connections**

1. Pin connections 1 and 2 are DC coupled and RF independent.

**Table 1. Maximum Ratings**

Rating	Symbol	Value	Unit
Drain-Source Voltage	$V_{DSS}$	-0.5, +65	Vdc
Gate-Source Voltage	$V_{GS}$	-6.0, +10	Vdc
Operating Voltage	$V_{DD}$	32, +0	Vdc
Storage Temperature Range	$T_{stg}$	-65 to +150	°C
Case Operating Temperature Range	$T_C$	-40 to +125	°C
Operating Junction Temperature Range (1,2)	$T_J$	-40 to +225	°C
CW Operation @ $T_C = 25^\circ\text{C}$ Derate above $25^\circ\text{C}$	CW	324 0.79	W W/°C

**Table 2. Thermal Characteristics**

Characteristic	Symbol	Value (2,3)	Unit
Thermal Resistance, Junction to Case Case Temperature $79^\circ\text{C}$ , 63 W CW, 28 Vdc, $I_{DQA} = 750\text{ mA}$ , $V_{GSB} = 0.7\text{ Vdc}$ , 2140 MHz	$R_{\theta JC}$	0.49	°C/W

**Table 3. ESD Protection Characteristics**

Test Methodology	Class
Human Body Model (per JESD22-A114)	2
Machine Model (per EIA/JESD22-A115)	B
Charge Device Model (per JESD22-C101)	IV

**Table 4. Electrical Characteristics** ( $T_A = 25^\circ\text{C}$  unless otherwise noted)

Characteristic	Symbol	Min	Typ	Max	Unit
----------------	--------	-----	-----	-----	------

**Off Characteristics (4)**

Zero Gate Voltage Drain Leakage Current ( $V_{DS} = 65\text{ Vdc}$ , $V_{GS} = 0\text{ Vdc}$ )	$I_{DSS}$	—	—	10	$\mu\text{Adc}$
Zero Gate Voltage Drain Leakage Current ( $V_{DS} = 28\text{ Vdc}$ , $V_{GS} = 0\text{ Vdc}$ )	$I_{DSS}$	—	—	5	$\mu\text{Adc}$
Gate-Source Leakage Current ( $V_{GS} = 5\text{ Vdc}$ , $V_{DS} = 0\text{ Vdc}$ )	$I_{GSS}$	—	—	1	$\mu\text{Adc}$

**On Characteristics - Side A (Carrier)**

Gate Threshold Voltage (5) ( $V_{DS} = 6\text{ Vdc}$ , $I_D = 146\ \mu\text{Adc}$ )	$V_{GS(th)}$	0.8	1.2	1.6	Vdc
Gate Quiescent Voltage (5) ( $V_{DD} = 28\text{ Vdc}$ , $I_{DA} = 750\text{ mAdc}$ , Measured in Functional Test)	$V_{GS(Q)}$	1.4	1.8	2.2	Vdc
Drain-Source On-Voltage (4) ( $V_{GS} = 10\text{ Vdc}$ , $I_D = 4.0\text{ Adc}$ )	$V_{DS(on)}$	0.1	0.2	0.3	Vdc

**On Characteristics - Side B (Peaking)**

Gate Threshold Voltage (5) ( $V_{DS} = 6\text{ Vdc}$ , $I_D = 303\ \mu\text{Adc}$ )	$V_{GS(th)}$	0.8	1.2	1.6	Vdc
Drain-Source On-Voltage (4) ( $V_{GS} = 10\text{ Vdc}$ , $I_D = 4.0\text{ Adc}$ )	$V_{DS(on)}$	0.1	0.2	0.3	Vdc

1. Continuous use at maximum temperature will affect MTTF.
2. MTTF calculator available at <http://www.freescale.com/rf>. Select Software & Tools/Development Tools/Calculators to access MTTF calculators by product.
3. Refer to AN1955, *Thermal Measurement Methodology of RF Power Amplifiers*. Go to <http://www.freescale.com/rf>. Select Documentation/Application Notes - AN1955
4. Side A and Side B are tied together for these measurements.
5. Each side of device measured separately.

(continued)

**Table 4. Electrical Characteristics** ( $T_A = 25^\circ\text{C}$  unless otherwise noted) (continued)

Characteristic	Symbol	Min	Typ	Max	Unit
<b>Functional Tests</b> <sup>(1,2,3)</sup> (In Freescale Doherty Test Fixture, 50 ohm system) $V_{DD} = 28\text{ Vdc}$ , $I_{DQA} = 750\text{ mA}$ , $V_{GSB} = 0.7\text{ Vdc}$ , $P_{out} = 63\text{ W Avg.}$ , $f = 2110\text{ MHz}$ , Single-Carrier W-CDMA, IQ Magnitude Clipping, Input Signal PAR = 9.9 dB @ 0.01% Probability on CCDF. ACPR measured in 3.84 MHz Channel Bandwidth @ $\pm 5\text{ MHz}$ Offset.					
Power Gain	$G_{ps}$	15.5	16.4	18.5	dB
Drain Efficiency	$\eta_D$	43.6	47.1	—	%
Output Peak-to-Average Ratio @ 0.01% Probability on CCDF	PAR	7.0	7.5	—	dB
Adjacent Channel Power Ratio	ACPR	—	-26.0	-24.1	dBc

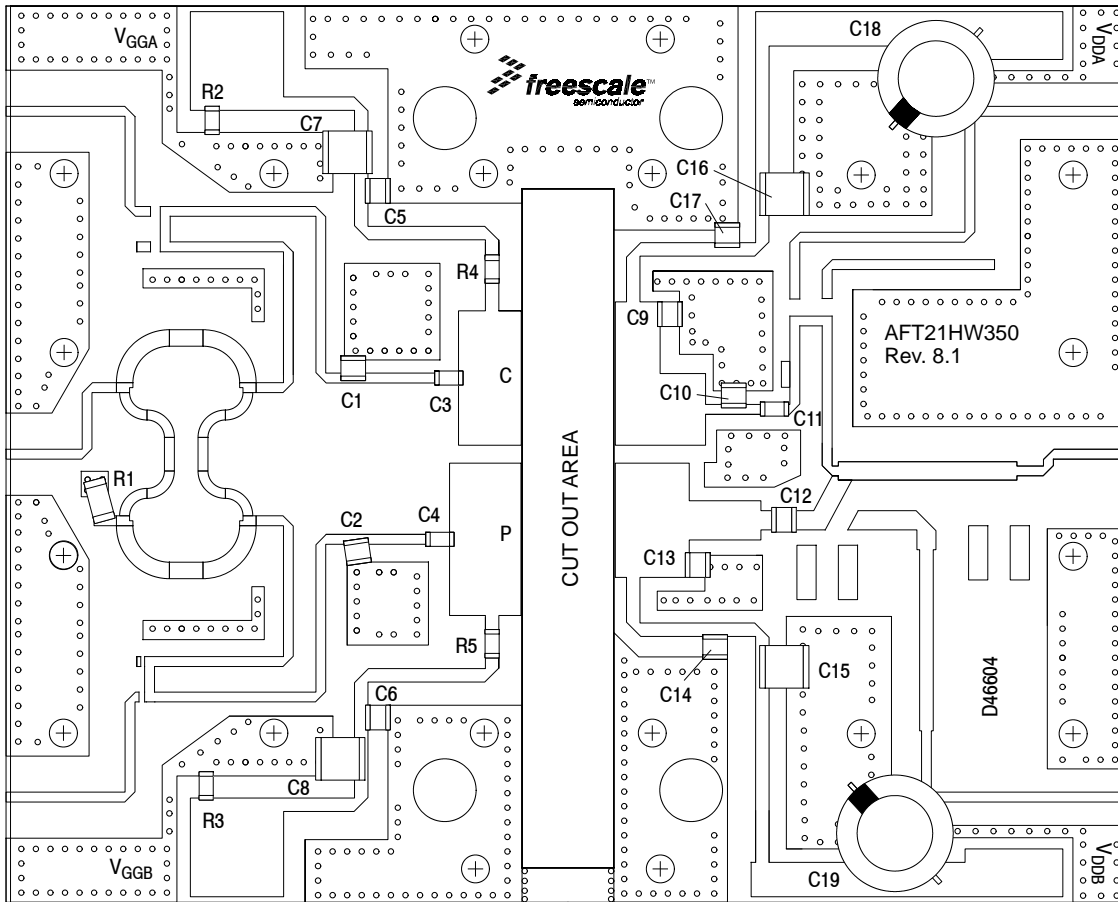
**Load Mismatch** (In Freescale Test Fixture, 50 ohm system)  $I_{DQA} = 750\text{ mA}$ ,  $f = 2140\text{ MHz}$ 

VSWR 10:1 at 32 Vdc, 195 W CW Output Power (3 dB Input Overdrive from 110 W CW Rated Power)	No Device Degradation
--	-----------------------

**Typical Performances** <sup>(3)</sup> (In Freescale Doherty Test Fixture, 50 ohm system)  $V_{DD} = 28\text{ Vdc}$ ,  $I_{DQA} = 750\text{ mA}$ ,  $V_{GSB} = 0.7\text{ Vdc}$ , 2110–2170 MHz Bandwidth

$P_{out}$ @ 1 dB Compression Point, CW	P1dB	—	110	—	W
$P_{out}$ @ 3 dB Compression Point <sup>(4)</sup>	P3dB	—	400	—	W
AM/PM (Maximum value measured at the P3dB compression point across the 2110 to 2170 MHz frequency range)	$\Phi$	—	40	—	$^\circ$
VBW Resonance Point (IMD Third Order Intermodulation Inflection Point)	$VBW_{res}$	—	140	—	MHz
Gain Flatness in 60 MHz Bandwidth @ $P_{out} = 63\text{ W Avg.}$	$G_F$	—	0.4	—	dB
Gain Variation over Temperature ( $-30^\circ\text{C}$ to $+85^\circ\text{C}$ )	$\Delta G$	—	0.01	—	dB/ $^\circ\text{C}$
Output Power Variation over Temperature ( $-30^\circ\text{C}$ to $+85^\circ\text{C}$ )	$\Delta P_{1dB}$	—	0.003	—	dB/ $^\circ\text{C}$

- $V_{DDA}$  and  $V_{ddb}$  must be tied together and powered by a single DC power supply.
- Part internally matched both on input and output.
- Measurements made with device in an asymmetrical Doherty configuration.
- $P_{3dB} = P_{avg} + 7.0\text{ dB}$  where  $P_{avg}$  is the average output power measured using an unclipped W-CDMA single-carrier input signal where output PAR is compressed to 7.0 dB @ 0.01% probability on CCDF.



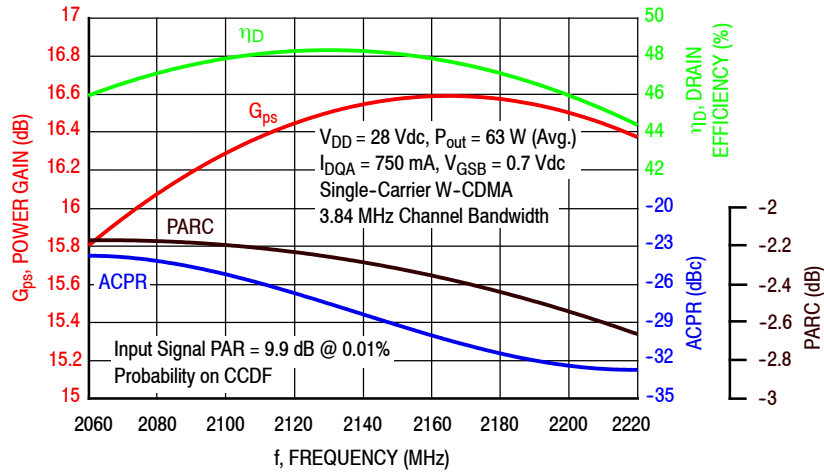
Note:  $V_{DDA}$  and  $V_{ddb}$  must be tied together and powered by a single DC power supply.

**Figure 2. AFT21H350W03SR6 Test Circuit Component Layout**

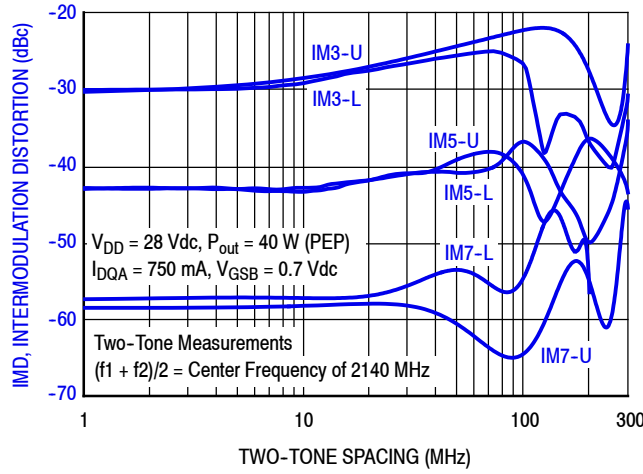
**Table 5. AFT21H350W03SR6 Test Circuit Component Designations and Values**

Part	Description	Part Number	Manufacturer
C1	0.3 pF Chip Capacitor	ATC100B0R3BT500XT	ATC
C2	0.7 pF Chip Capacitor	ATC100B0R7BT500XT	ATC
C3, C4, C11, C12	6.8 pF Chip Capacitors	ATC100B6R8CT500XT	ATC
C5, C6, C14, C17	9.1 pF Chip Capacitors	ATC100B9R1CT500XT	ATC
C7, C8, C15, C16	10 $\mu$ F Chip Capacitors	GRM55DR61H106KA88L	Murata
C9	0.5 pF Chip Capacitor	ATC100B0R5BT500XT	ATC
C10, C13	0.8 pF Chip Capacitors	ATC100B0R8BT500XT	ATC
C18, C19	470 $\mu$ F, 63 V Electrolytic Capacitors	MCGPR63V477M13X26-RH	Multicomp
R1	51 $\Omega$ , 1/2 W Chip Resistor	CRCW201051R0JNEF	Vishay
R2, R3	3.0 K $\Omega$ , 1/4 W Chip Resistors	CRCW12063K00FKEA	Vishay
R4, R5	2.7 $\Omega$ , 1/4 W Chip Resistors	CRCW12062R70FKEA	Vishay
PCB	Rogers RO4350B, 0.020", $\epsilon_r = 3.5$	D46604	MTL

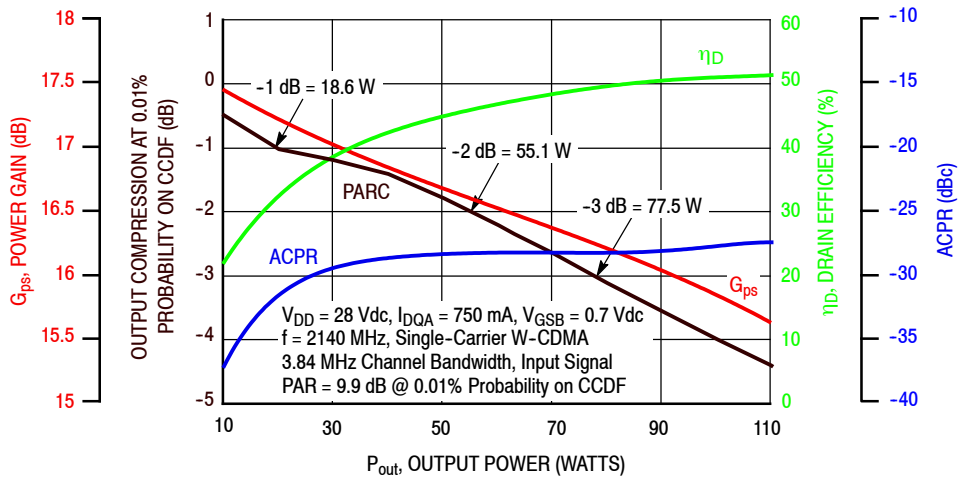
### TYPICAL CHARACTERISTICS



**Figure 3. Single-Carrier Output Peak-to-Average Ratio Compression (PARC) Broadband Performance @  $P_{out}$  = 63 Watts Avg.**

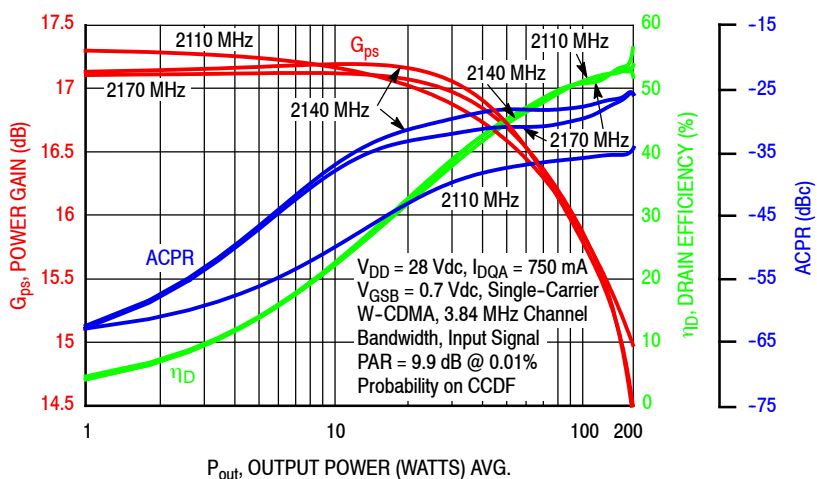


**Figure 4. Intermodulation Distortion Products versus Two-Tone Spacing**

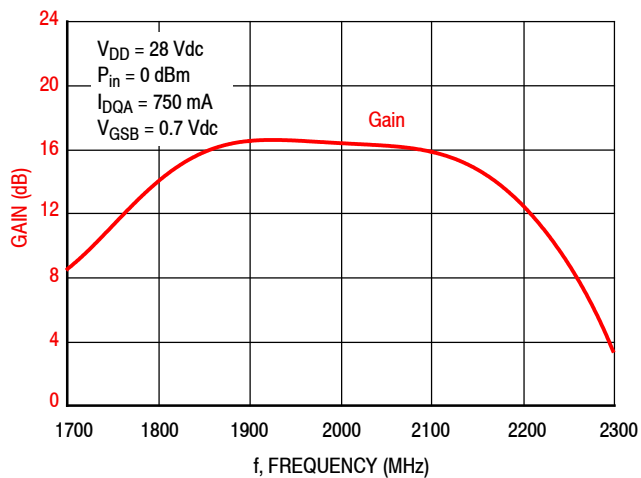


**Figure 5. Output Peak-to-Average Ratio Compression (PARC) versus Output Power**

### TYPICAL CHARACTERISTICS



**Figure 6. Single-Carrier W-CDMA Power Gain, Drain Efficiency and ACPR versus Output Power**



**Figure 7. Broadband Frequency Response**

$V_{DD} = 28 \text{ Vdc}$ ,  $I_{DQA} = 763 \text{ mA}$ , Pulsed CW, 10  $\mu\text{sec}(\text{on})$ , 10% Duty Cycle

f (MHz)	$Z_{\text{source}} (\Omega)$	$Z_{\text{in}} (\Omega)$	Max Output Power					
			P1dB					
			$Z_{\text{load}}^{(1)} (\Omega)$	Gain (dB)	(dBm)	(W)	$\eta_D$ (%)	AM/PM (°)
2110	4.29 - j7.28	3.75 + j6.90	3.07 - j4.95	18.7	51.9	155	54.7	-12
2140	5.23 - j7.74	4.64 + j7.21	3.16 - j5.18	18.7	51.9	156	54.8	-13
2170	6.26 - j7.95	5.75 + j7.35	3.27 - j5.37	18.9	51.9	155	54.1	-13

f (MHz)	$Z_{\text{source}} (\Omega)$	$Z_{\text{in}} (\Omega)$	Max Output Power					
			P3dB					
			$Z_{\text{load}}^{(2)} (\Omega)$	Gain (dB)	(dBm)	(W)	$\eta_D$ (%)	AM/PM (°)
2110	4.29 - j7.28	3.96 + j7.42	3.18 - j5.59	16.5	52.8	189	57.1	-18
2140	5.23 - j7.74	5.04 + j7.81	3.30 - j5.71	16.6	52.8	189	56.8	-19
2170	6.26 - j7.95	6.44 + j7.94	3.40 - j5.88	16.7	52.7	187	56.2	-20

(1) Load impedance for optimum P1dB power.

(2) Load impedance for optimum P3dB power.

$Z_{\text{source}}$  = Measured impedance presented to the input of the device at the package reference plane.

$Z_{\text{in}}$  = Impedance as measured from gate contact to ground.

$Z_{\text{load}}$  = Measured impedance presented to the output of the device at the package reference plane.

**Figure 8. Carrier Side Load Pull Performance — Maximum Power Tuning**

$V_{DD} = 28 \text{ Vdc}$ ,  $I_{DQA} = 763 \text{ mA}$ , Pulsed CW, 10  $\mu\text{sec}(\text{on})$ , 10% Duty Cycle

f (MHz)	$Z_{\text{source}} (\Omega)$	$Z_{\text{in}} (\Omega)$	Max Drain Efficiency					
			P1dB					
			$Z_{\text{load}}^{(1)} (\Omega)$	Gain (dB)	(dBm)	(W)	$\eta_D$ (%)	AM/PM (°)
2110	4.29 - j7.28	3.63 + j7.22	5.78 - j1.16	21.6	49.6	91	65.4	-22
2140	5.23 - j7.74	4.54 + j7.46	5.88 - j1.54	21.5	49.8	95	65.1	-21
2170	6.26 - j7.95	5.66 + j7.76	4.75 - j1.49	21.6	49.8	96	65.0	-23

f (MHz)	$Z_{\text{source}} (\Omega)$	$Z_{\text{in}} (\Omega)$	Max Drain Efficiency					
			P3dB					
			$Z_{\text{load}}^{(2)} (\Omega)$	Gain (dB)	(dBm)	(W)	$\eta_D$ (%)	AM/PM (°)
2110	4.29 - j7.28	3.84 + j7.59	6.49 - j2.11	19.4	50.6	114	65.3	-28
2140	5.23 - j7.74	4.91 + j8.02	6.10 - j1.54	19.5	50.4	110	65.9	-30
2170	6.26 - j7.95	6.28 + j8.14	5.82 - j2.06	19.4	50.7	117	65.7	-29

(1) Load impedance for optimum P1dB efficiency.

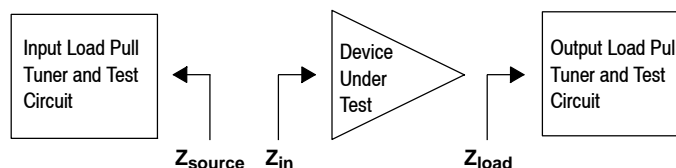
(2) Load impedance for optimum P3dB efficiency.

$Z_{\text{source}}$  = Measured impedance presented to the input of the device at the package reference plane.

$Z_{\text{in}}$  = Impedance as measured from gate contact to ground.

$Z_{\text{load}}$  = Measured impedance presented to the output of the device at the package reference plane.

**Figure 9. Carrier Side Load Pull Performance — Maximum Drain Efficiency Tuning**



$V_{DD} = 28 \text{ Vdc}$ ,  $V_{GSB} = 0.7 \text{ Vdc}$ , Pulsed CW, 10  $\mu\text{sec}(\text{on})$ , 10% Duty Cycle

f (MHz)	$Z_{\text{source}} (\Omega)$	$Z_{\text{in}} (\Omega)$	Max Output Power					
			P1dB					
			$Z_{\text{load}}^{(1)} (\Omega)$	Gain (dB)	(dBm)	(W)	$\eta_D$ (%)	AM/PM (°)
2110	2.76 - j5.24	2.87 + j5.85	2.36 - j4.99	14.4	54.7	292	54.6	-22
2140	3.54 - j5.55	3.73 + j6.27	2.61 - j5.09	14.6	54.7	292	55.0	-23
2170	5.02 - j5.82	5.01 + j6.41	2.80 - j5.30	14.6	54.6	288	53.5	-25

f (MHz)	$Z_{\text{source}} (\Omega)$	$Z_{\text{in}} (\Omega)$	Max Output Power					
			P3dB					
			$Z_{\text{load}}^{(2)} (\Omega)$	Gain (dB)	(dBm)	(W)	$\eta_D$ (%)	AM/PM (°)
2110	2.76 - j5.24	3.16 + j6.20	2.51 - j5.47	12.1	55.3	337	54.4	-28
2140	3.54 - j5.55	4.25 + j6.63	2.77 - j5.62	12.3	55.3	336	53.9	-29
2170	5.02 - j5.82	5.80 + j6.63	3.08 - j5.67	12.4	55.2	332	54.1	-31

(1) Load impedance for optimum P1dB power.

(2) Load impedance for optimum P3dB power.

$Z_{\text{source}}$  = Measured impedance presented to the input of the device at the package reference plane.

$Z_{\text{in}}$  = Impedance as measured from gate contact to ground.

$Z_{\text{load}}$  = Measured impedance presented to the output of the device at the package reference plane.

**Figure 10. Peaking Side Load Pull Performance — Maximum Power Tuning**

$V_{DD} = 28 \text{ Vdc}$ ,  $V_{GSB} = 0.7 \text{ Vdc}$ , Pulsed CW, 10  $\mu\text{sec}(\text{on})$ , 10% Duty Cycle

f (MHz)	$Z_{\text{source}} (\Omega)$	$Z_{\text{in}} (\Omega)$	Max Drain Efficiency					
			P1dB					
			$Z_{\text{load}}^{(1)} (\Omega)$	Gain (dB)	(dBm)	(W)	$\eta_D$ (%)	AM/PM (°)
2110	2.76 - j5.24	2.36 + j6.00	3.43 - j2.05	15.8	52.8	189	66.0	-29
2140	3.54 - j5.55	3.08 + j6.45	3.22 - j2.11	15.9	52.8	191	65.9	-31
2170	5.02 - j5.82	4.19 + j6.80	3.07 - j2.13	15.9	52.8	190	65.0	-33

f (MHz)	$Z_{\text{source}} (\Omega)$	$Z_{\text{in}} (\Omega)$	Max Drain Efficiency					
			P3dB					
			$Z_{\text{load}}^{(2)} (\Omega)$	Gain (dB)	(dBm)	(W)	$\eta_D$ (%)	AM/PM (°)
2110	2.76 - j5.24	2.74 + j6.36	3.71 - j2.53	13.7	53.7	233	65.3	-36
2140	3.54 - j5.55	3.67 + j6.84	3.57 - j2.44	13.8	53.6	231	65.1	-39
2170	5.02 - j5.82	5.15 + j7.06	3.45 - j2.52	13.8	53.7	234	64.3	-41

(1) Load impedance for optimum P1dB efficiency.

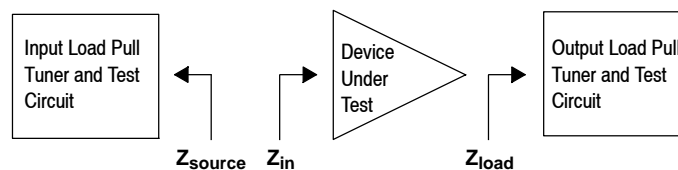
(2) Load impedance for optimum P3dB efficiency.

$Z_{\text{source}}$  = Measured impedance presented to the input of the device at the package reference plane.

$Z_{\text{in}}$  = Impedance as measured from gate contact to ground.

$Z_{\text{load}}$  = Measured impedance presented to the output of the device at the package reference plane.

**Figure 11. Peaking Side Load Pull Performance — Maximum Drain Efficiency Tuning**





### P1dB - TYPICAL CARRIER SIDE LOAD PULL CONTOURS — 2140 MHz

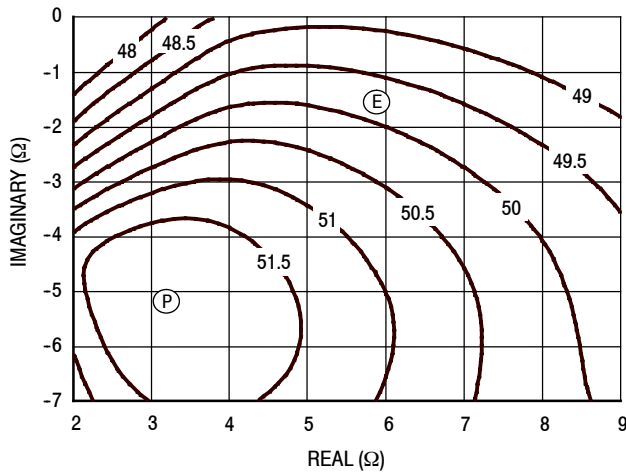


Figure 12. P1dB Load Pull Output Power Contours (dBm)

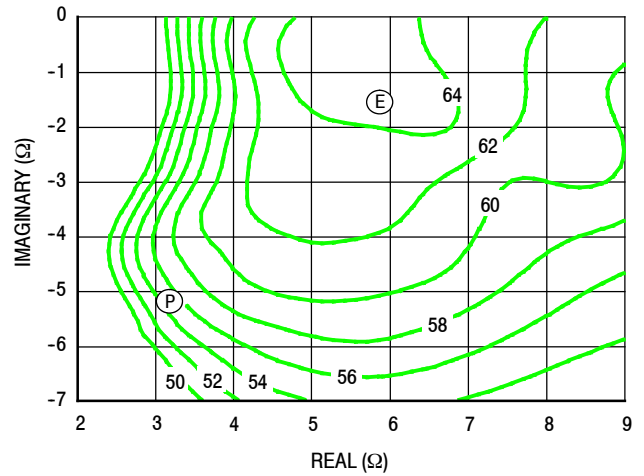


Figure 13. P1dB Load Pull Efficiency Contours (%)

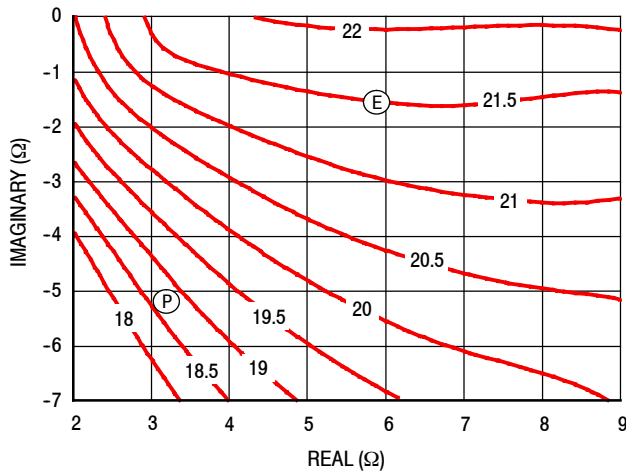


Figure 14. P1dB Load Pull Gain Contours (dB)

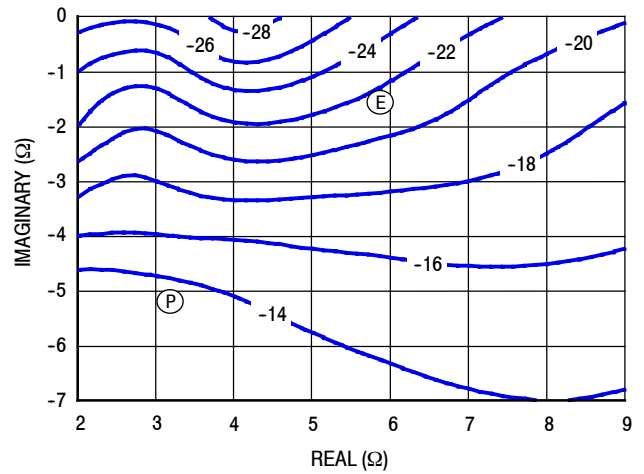


Figure 15. P1dB Load Pull AM/PM Contours (°)

**NOTE:** (P) = Maximum Output Power  
(E) = Maximum Drain Efficiency

- Gain
- Drain Efficiency
- Linearity
- Output Power

### P3dB - TYPICAL CARRIER SIDE LOAD PULL CONTOURS — 2140 MHz

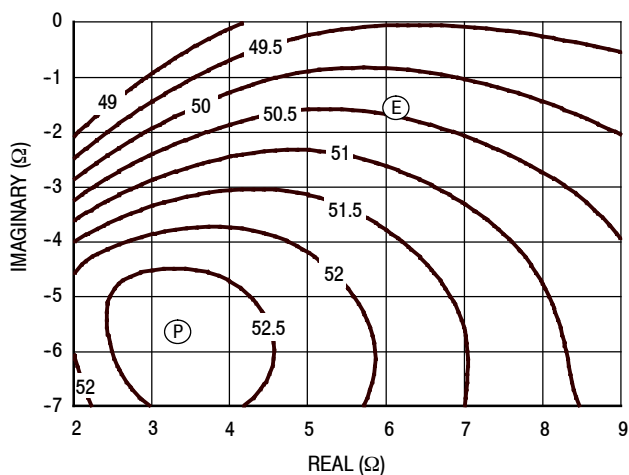


Figure 16. P3dB Load Pull Output Power Contours (dBm)

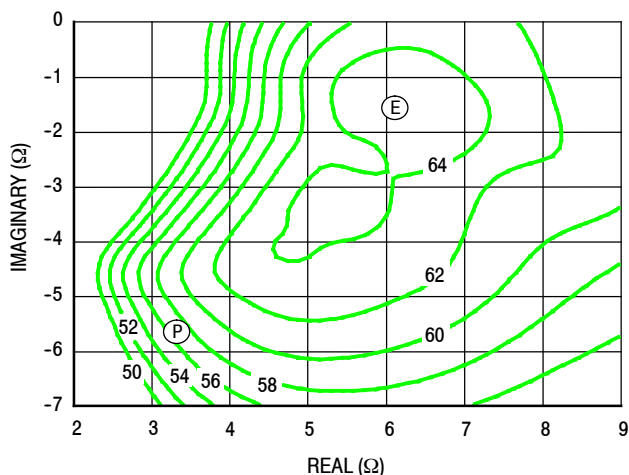


Figure 17. P3dB Load Pull Efficiency Contours (%)

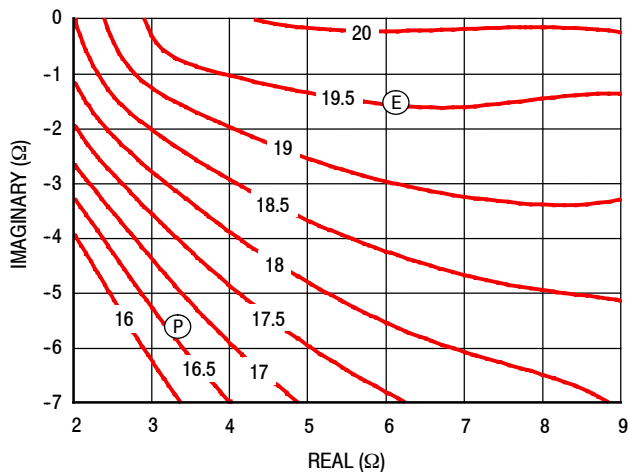


Figure 18. P3dB Load Pull Gain Contours (dB)

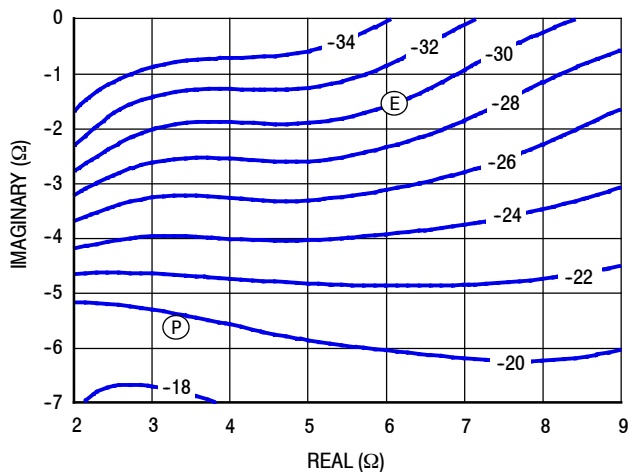


Figure 19. P3dB Load Pull AM/PM Contours (°)

**NOTE:** (P) = Maximum Output Power  
 (E) = Maximum Drain Efficiency

- Gain
- Drain Efficiency
- Linearity
- Output Power

### P1dB - TYPICAL PEAKING SIDE LOAD PULL CONTOURS — 2140 MHz

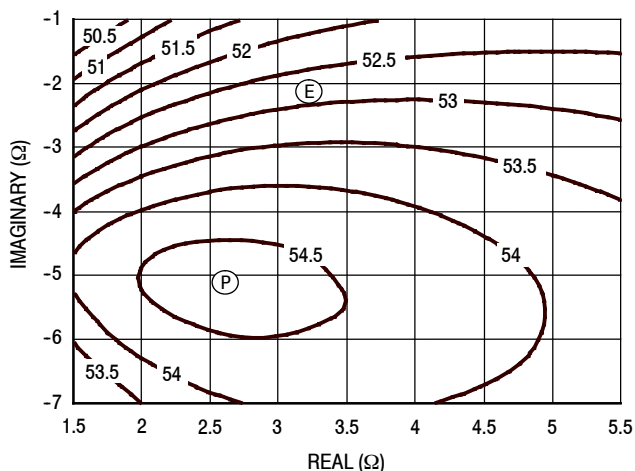


Figure 20. P1dB Load Pull Output Power Contours (dBm)

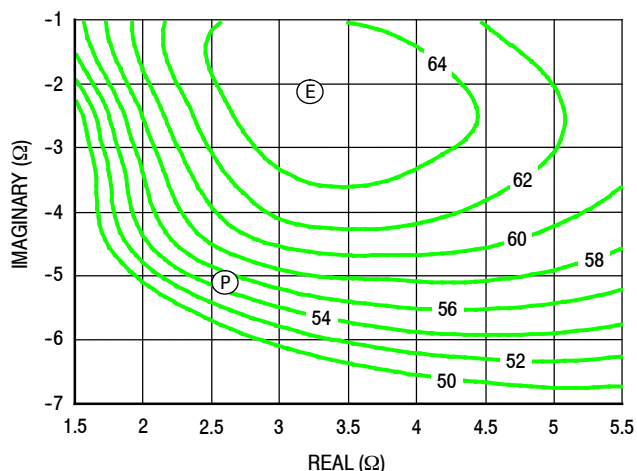


Figure 21. P1dB Load Pull Efficiency Contours (%)

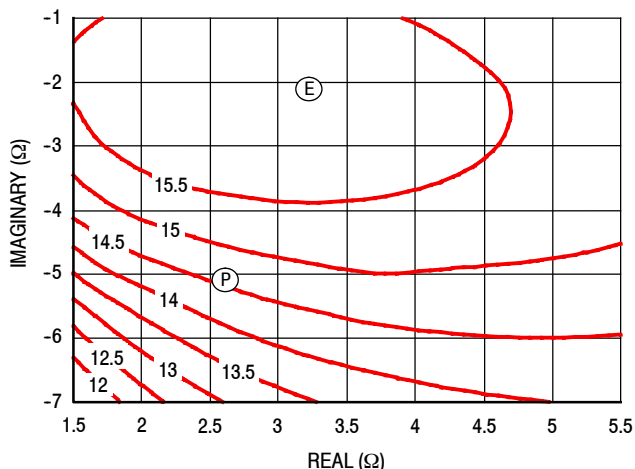


Figure 22. P1dB Load Pull Gain Contours (dB)

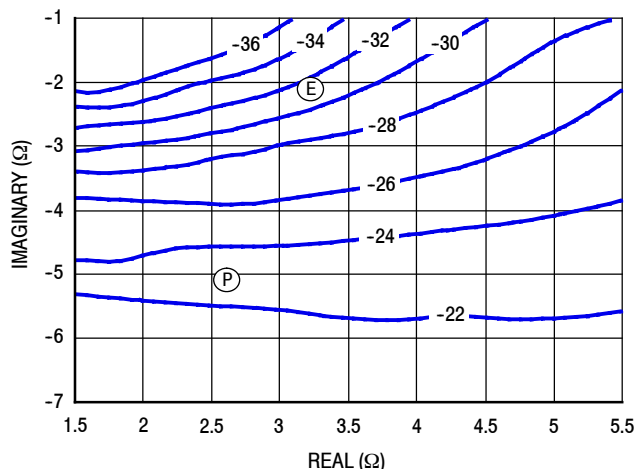


Figure 23. P1dB Load Pull AM/PM Contours (°)

**NOTE:** (P) = Maximum Output Power  
(E) = Maximum Drain Efficiency

- Gain
- Drain Efficiency
- Linearity
- Output Power

### P3dB - TYPICAL PEAKING SIDE LOAD PULL CONTOURS — 2140 MHz

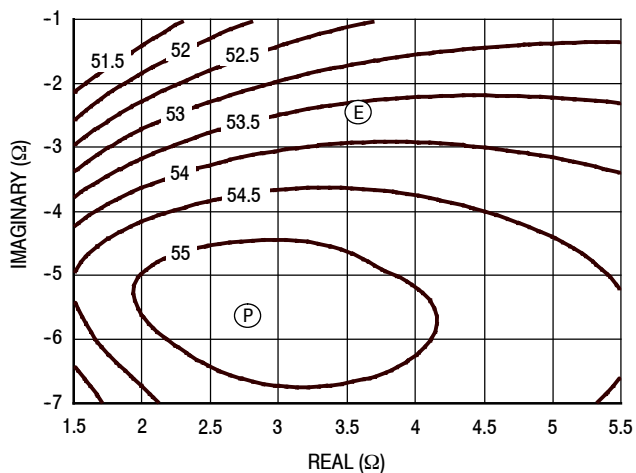


Figure 24. P3dB Load Pull Output Power Contours (dBm)

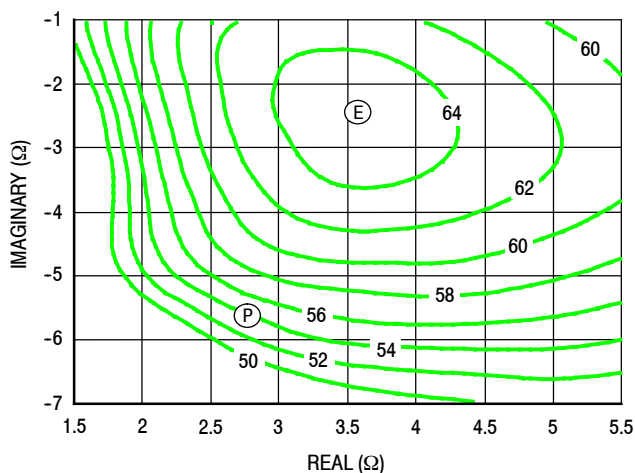


Figure 25. P3dB Load Pull Efficiency Contours (%)

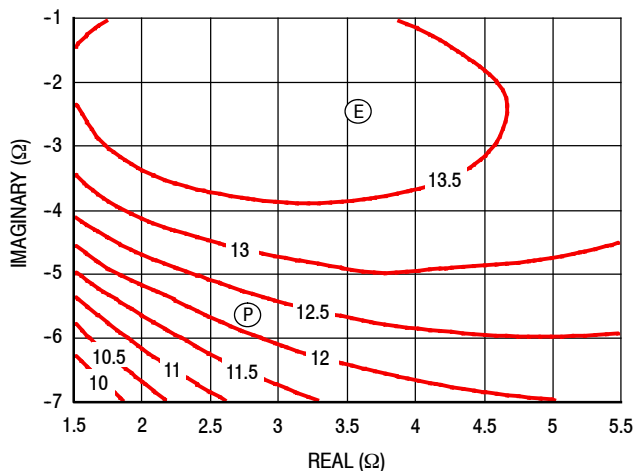


Figure 26. P3dB Load Pull Gain Contours (dB)

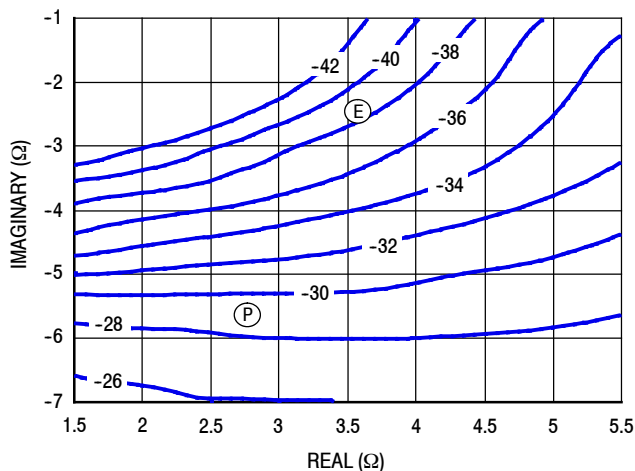
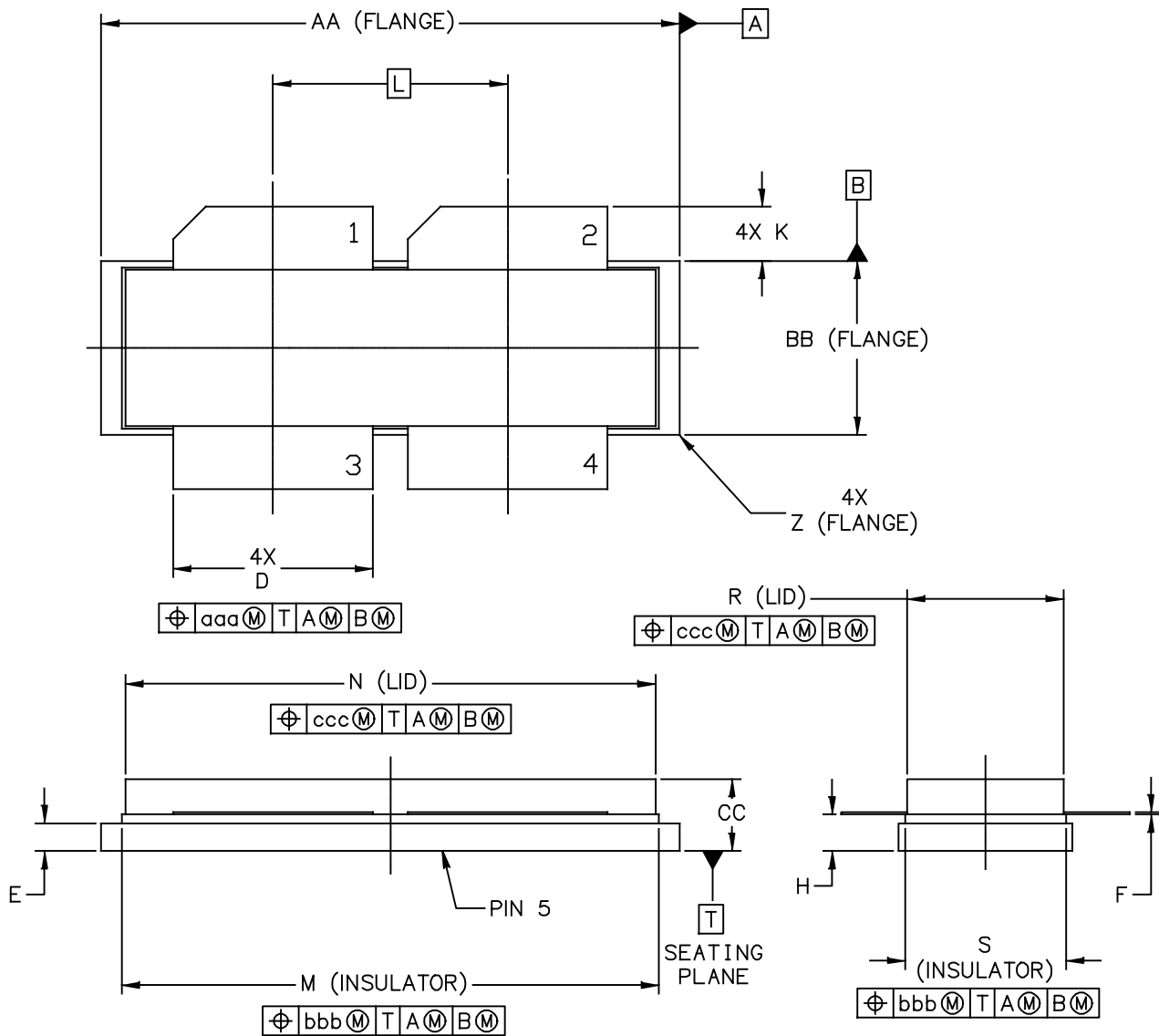


Figure 27. P3dB Load Pull AM/PM Contours (°)

**NOTE:** (P) = Maximum Output Power  
(E) = Maximum Drain Efficiency

- Gain
- Drain Efficiency
- Linearity
- Output Power

### PACKAGE DIMENSIONS

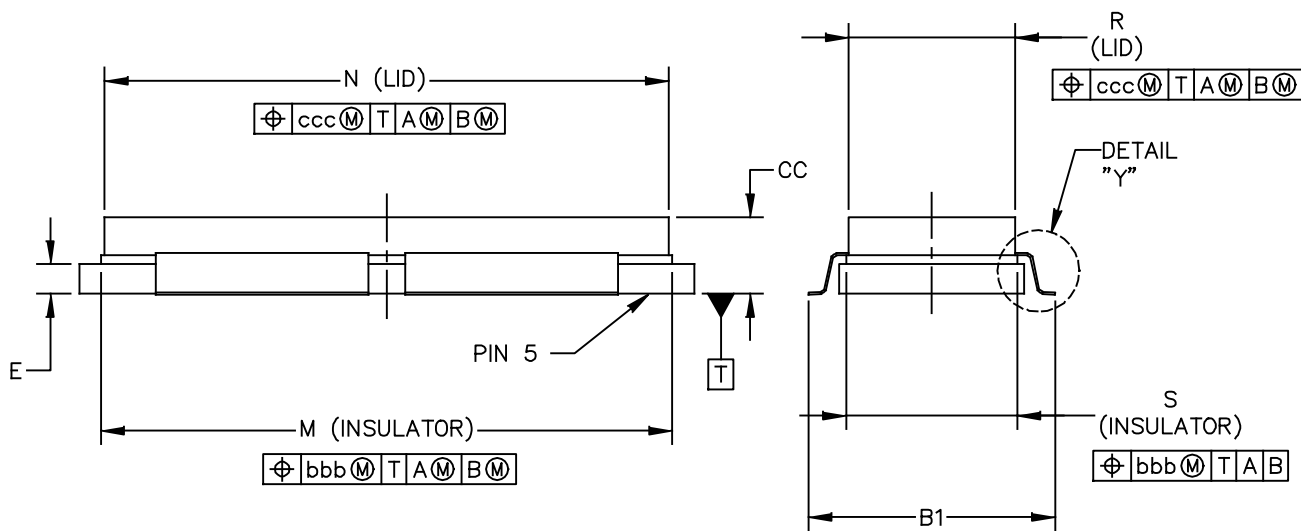
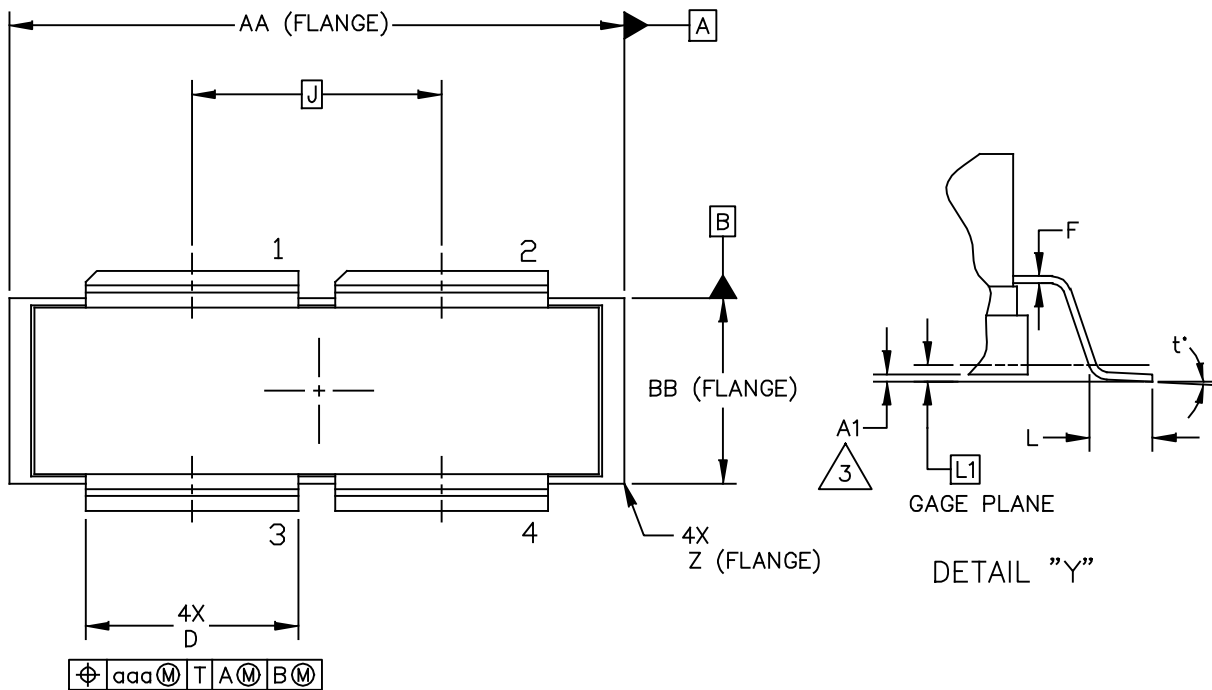


© FREESCALE SEMICONDUCTOR, INC. ALL RIGHTS RESERVED.	MECHANICAL OUTLINE	PRINT VERSION NOT TO SCALE
TITLE:  NI-1230-4S	DOCUMENT NO: 98ARB18247C STANDARD: NON-JEDEC	REV: G  01 MAR 2013

NOTES:

1. INTERPRET DIMENSIONS AND TOLERANCES PER ASME Y14.5M–1994.
2. CONTROLLING DIMENSION: INCH
3. DIMENSION H IS MEASURED .030 INCH (0.762 MM) AWAY FROM PACKAGE BODY

DIM	INCHES		MILLIMETERS		DIM	INCHES		MILLIMETERS	
	MIN	MAX	MIN	MAX		MIN	MAX	MIN	MAX
AA	1.265	1.275	32.13	32.39	R	.355	.365	9.02	9.27
BB	.395	.405	10.03	10.29	S	.365	.375	9.27	9.53
CC	.170	.190	4.32	4.83	Z	R.000	R.040	R0.00	R1.02
D	.455	.465	11.56	11.81					
E	.062	.066	1.57	1.68	aaa	.013		0.33	
F	.004	.007	0.10	0.18	bbb	.010		0.25	
H	.082	.090	2.08	2.29	ccc	.020		0.51	
K	.117	.137	2.97	3.48					
L	.540 BSC		13.72 BSC						
M	1.219	1.241	30.96	31.52					
N	1.218	1.242	30.94	31.55					
© FREESCALE SEMICONDUCTOR, INC. ALL RIGHTS RESERVED.			MECHANICAL OUTLINE			PRINT VERSION NOT TO SCALE			
TITLE:  NI-1230-4S					DOCUMENT NO: 98ARB18247C      REV: G				
					STANDARD: NON-JEDEC				
					01 MAR 2013				



© FREESCALE SEMICONDUCTOR, INC. ALL RIGHTS RESERVED.	MECHANICAL OUTLINE	PRINT VERSION NOT TO SCALE
TITLE:  NI-1230-4S GULL	DOCUMENT NO: 98ASA00459D	REV: A
	STANDARD: NON-JEDEC	
	07 MAR 2013	

NOTES:

1. INTERPRET DIMENSIONS AND TOLERANCES PER ASME Y14.5M-1994.

2. CONTROLLING DIMENSION: INCH

3. DIMENSION A1 IS MEASURED WITH REFERENCE TO DATUM T. THE POSITIVE VALUE IMPLIES THAT THE PACKAGE BOTTOM IS HIGHER THAN THE LEAD BOTTOM.

DIM	INCHES		MILLIMETERS		DIM	INCHES		MILLIMETERS	
	MIN	MAX	MIN	MAX		MIN	MAX	MIN	MAX
AA	1.265	1.275	32.13	32.39	R	.355	.365	9.02	9.27
A1	-.001	.011	-0.03	0.28	S	.365	.375	9.27	9.53
BB	.395	.405	10.03	10.29	Z	R.000	R.040	R0.00	R1.02
B1	.564	.574	14.32	14.58	t'	0'	8'	0'	8'
CC	.170	.190	4.32	4.83					
D	.455	.465	11.56	11.81	aaa	.013		0.33	
E	.062	.066	1.57	1.68	bbb	.010		0.25	
F	.004	.007	0.10	0.18	ccc	.020		0.51	
J	.540 BSC		13.72 BSC						
L	.038	.046	0.97	1.17					
L1	.01 BSC		0.25 BSC						
M	1.219	1.241	30.96	31.52					
N	1.218	1.242	30.94	31.55					
© FREESCALE SEMICONDUCTOR, INC. ALL RIGHTS RESERVED.			MECHANICAL OUTLINE			PRINT VERSION NOT TO SCALE			
TITLE:  NI-1230-4S GULL					DOCUMENT NO: 98ASA00459D      REV: A				
					STANDARD: NON-JEDEC				
					07 MAR 2013				



## PRODUCT DOCUMENTATION, SOFTWARE AND TOOLS

Refer to the following documents, software and tools to aid your design process.

### Application Notes

- AN1955: Thermal Measurement Methodology of RF Power Amplifiers

### Engineering Bulletins

- EB212: Using Data Sheet Impedances for RF LDMOS Devices

### Software

- Electromigration MTTF Calculator
- RF High Power Model
- .s2p File

### Development Tools

- Printed Circuit Boards

For Software and Tools, do a Part Number search at <http://www.freescale.com>, and select the "Part Number" link. Go to the Software & Tools tab on the part's Product Summary page to download the respective tool.

## REVISION HISTORY

The following table summarizes revisions to this document.

Revision	Date	Description
0	Sept. 2013	• Initial Release of Data Sheet

### ***How to Reach Us:***

**Home Page:**  
[freescale.com](http://freescale.com)

**Web Support:**  
[freescale.com/support](http://freescale.com/support)

Information in this document is provided solely to enable system and software implementers to use Freescale products. There are no express or implied copyright licenses granted hereunder to design or fabricate any integrated circuits based on the information in this document.

Freescale reserves the right to make changes without further notice to any products herein. Freescale makes no warranty, representation, or guarantee regarding the suitability of its products for any particular purpose, nor does Freescale assume any liability arising out of the application or use of any product or circuit, and specifically disclaims any and all liability, including without limitation consequential or incidental damages. "Typical" parameters that may be provided in Freescale data sheets and/or specifications can and do vary in different applications, and actual performance may vary over time. All operating parameters, including "typicals," must be validated for each customer application by customer's technical experts. Freescale does not convey any license under its patent rights nor the rights of others. Freescale sells products pursuant to standard terms and conditions of sale, which can be found at the following address: [freescale.com/SalesTermsandConditions](http://freescale.com/SalesTermsandConditions).

Freescale and the Freescale logo are trademarks of Freescale Semiconductor, Inc., Reg. U.S. Pat. & Tm. Off. Airfast is a trademark of Freescale Semiconductor, Inc. All other product or service names are the property of their respective owners.

© 2013 Freescale Semiconductor, Inc.