

ELM95xxxxE CMOS PWM step-up DC/DC converter

<http://www.elm-tech.com>

■ General description

ELM95xxxxE is CMOS PWM step-up DC/DC converter which consists of reference voltage source, error amplifier, oscillation circuit, start-up circuit, PWM control circuit, switching current limit circuit, switch transistor and output voltage setting resistor. For external parts, coil, diode and capacitor are possible choices; with external parts, are 2.7V, 3.0V, 3.3V and 5.0V; ELM95 series can also be designed as semi-custom IC within the range of 2.5V to 5.5V by 0.1V step. With newly-developed PWM control circuit, ELM95 series is able to modulate switching time smoothly with constant frequency and consequently generates stable output with small ripples. There are two switching frequency and maximum duty ratio available: (Switching frequency, Maximum duty ratio)=(55kHz, 60%) and (100kHz, 77%).

■ Features

- Output voltage range : 2.5V to 5.5V(by 0.1V step)
- Low voltage operation : $V_{in} \geq 0.9V$ (No load)
- Low power operation : 35 μ W(ELM9530AxE)
- High efficiency : Typ.85%
- High output voltage accuracy : $\pm 2.5\%$
- Constant switching frequency : Typ.55kHz(Type A), Typ.100kHz(Type B)
- Output current (e.g.) : 100mA(Type B, $V_{in}=1.5V$, $V_{out}=3.3V$)
- Small ripples : Ceramic capacitor can be used for output capacitor.
- Package : SOT-89, SOT-23

■ Application

- Constant voltage source for battery-operated devices
- Constant voltage source for cameras
- Portable communication equipments
- Local regulator

■ Maximum absolute ratings

Parameter	Symbol	Limit	Unit
Apply voltage to LX pin	V_{Lx}	$V_{SS}-0.3$ to 8.0	V
Apply voltage to VOUT pin	V_{out}	$V_{SS}-0.3$ to 8.0	V
Output current of LX pin	I_{Lx}	500	mA
Power dissipation	P_d	500 (SOT-89)	mW
		250 (SOT-23)	
Operating temperature	T_{op}	-40 to +85	$^{\circ}C$
Storage temperature	T_{stg}	-55 to +125	$^{\circ}C$

ELM95xxxxE CMOS PWM step-up DC/DC converter

<http://www.elm-tech.com>

■ Selection guide

ELM95xxxxE-x

Symbol		
a, b	Output voltage	e.g.: 27: Vout=2.7V, 30: Vout=3.0V 33: Vout=3.3V, 50: Vout=5.0V
c	Switching frequency and maximum duty ratio	A : Switching frequency=55kHz, Maximum duty ratio=60% B : Switching frequency=100kHz, Maximum duty ratio=77%
d	Package	A : SOT-89 B : SOT-23
e	Product version	E
f	Taping direction	S: Refer to PKG file N: Refer to PKG file

ELM95 x x x x E - x
 ↑ ↑ ↑ ↑ ↑ ↑
 a b c d e f

■ Pin configuration

SOT-89(TOP VIEW)

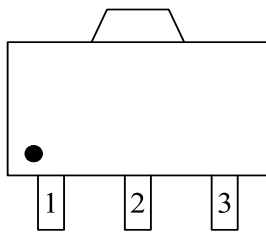

Pin No.	Pin name
1	VSS
2	VOUT
3	LX

SOT-23(TOP VIEW)

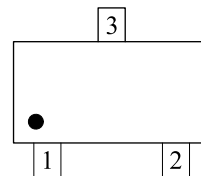

Pin No.	Pin name
1	VSS
2	LX
3	VOUT

■ Standard circuit

ELM95xxAxE

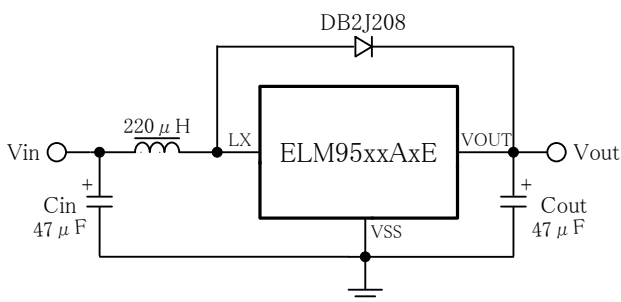

ELM95xxBxE

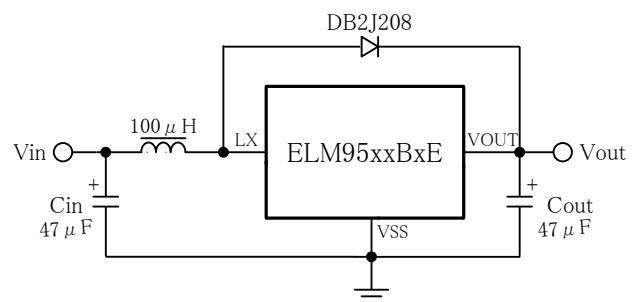

Ceramic capacitors are recommended.

ELM95xxxxE CMOS PWM step-up DC/DC converter

<http://www.elm-tech.com>

■Block diagram

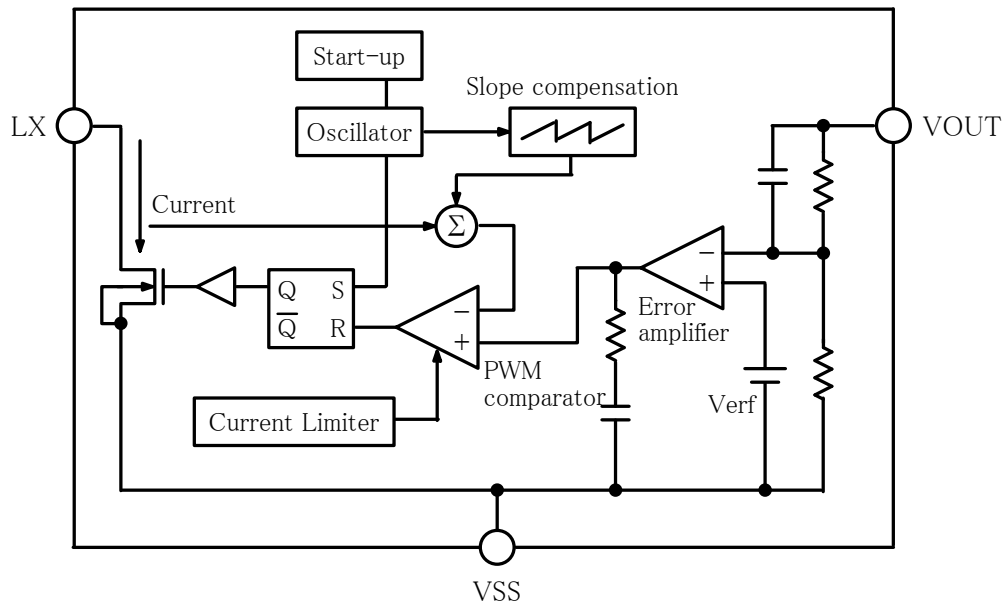

■Electrical characteristics (ELM95xxAxE)

Vout=2.7V(ELM9527AxE)

L=220μH, Cin=Cout=47μF, D=DB2J208, Vss=0V, Top=25°C

Parameter	Symbol	Condition	Min.	Typ.	Max.	Unit
Input voltage	Vin		0.9		7.0	V
Starting voltage	Vst	No load			0.9	V
Holding voltage	Vhold	Iout=1mA			0.7	V
Current consumption	Iss	Vin=1.5V, Iout=1mA		9	18	μA
Output voltage	Vout	Vin=1.5V, Iout=1mA	2.633	2.700	2.767	V
On-resistance of LX switch	Ron	Vout=Vout(T)×0.95		0.65	1.20	Ω
Leakage current of LX pin	Ilxl	Vout=Vlx=7.0V			1.0	μA
Oscillating frequency	Fosc	Vout=Vout(T)×0.95	35	55	75	kHz
Maximum duty ratio	Duty	Vout=Vout(T)×0.95	45	60	75	%
Current limit of LX switch	Ilimit	Vout=Vout(T)×0.95		600		mA

* Vout(T) : Typ. value of Vout

Vout=3.0V(ELM9530AxE)

L=220μH, Cin=Cout=47μF, D=DB2J208, Vss=0V, Top=25°C

Parameter	Symbol	Condition	Min.	Typ.	Max.	Unit
Input voltage	Vin		0.9		7.0	V
Starting voltage	Vst	No load			0.9	V
Holding voltage	Vhold	Iout=1mA			0.7	V
Current consumption	Iss	Vin=1.5V, Iout=1mA		12	20	μA
Output voltage	Vout	Vin=1.5V, Iout=1mA	2.925	3.000	3.075	V
On-resistance of LX switch	Ron	Vout=Vout(T)×0.95		0.6	1.1	Ω
Leakage current of LX pin	Ilxl	Vout=Vlx=7.0V			1.0	μA
Oscillating frequency	Fosc	Vout=Vout(T)×0.95	35	55	75	kHz
Maximum duty ratio	Duty	Vout=Vout(T)×0.95	45	60	75	%
Current limit of LX switch	Ilimit	Vout=Vout(T)×0.95		600		mA

* Vout(T) : Typ. value of Vout

ELM95xxxxE CMOS PWM step-up DC/DC converter

http://www.elm-tech.com

Vout=3.3V(ELM9533AxE)

L=220μH, Cin=Cout=47μF, D=DB2J208, Vss=0V, Top=25°C

Parameter	Symbol	Condition	Min.	Typ.	Max.	Unit
Input voltage	Vin		0.9		7.0	V
Starting voltage	Vst	No load			0.9	V
Holding voltage	Vhold	Iout=1mA			0.7	V
Current consumption	Iss	Vin=1.5V, Iout=1mA		14	23	μA
Output voltage	Vout	Vin=1.5V, Iout=1mA	3.218	3.300	3.382	V
On-resistance of LX switch	Ron	Vout=Vout(T)×0.95		0.55	1.00	Ω
Leakage current of LX pin	Ilxl	Vout=Vlx=7.0V			1.0	μA
Oscillating frequency	Fosc	Vout=Vout(T)×0.95	35	55	75	kHz
Maximum duty ratio	Duty	Vout=Vout(T)×0.95	45	60	75	%
Current limit of LX switch	Ilimit	Vout=Vout(T)×0.95		600		mA

* Vout(T) : Typ. value of Vout

Vout=5.0V(ELM9550AxE)

L=220μH, Cin=Cout=47μF, D=DB2J208, Vss=0V, Top=25°C

Parameter	Symbol	Condition	Min.	Typ.	Max.	Unit
Input voltage	Vin		0.9		7.0	V
Starting voltage	Vst	No load			0.9	V
Holding voltage	Vhold	Iout=1mA			0.7	V
Current consumption	Iss	Vin=3.0V, Iout=1mA		30	45	μA
Output voltage	Vout	Vin=3.0V, Iout=1mA	4.875	5.000	5.125	V
On-resistance of LX switch	Ron	Vout=Vout(T)×0.95		0.45	0.80	Ω
Leakage current of LX pin	Ilxl	Vout=Vlx=7.0V			1.0	μA
Oscillating frequency	Fosc	Vout=Vout(T)×0.95	35	55	75	kHz
Maximum duty ratio	Duty	Vout=Vout(T)×0.95	45	60	75	%
Current limit of LX switch	Ilimit	Vout=Vout(T)×0.95		600		mA

* Vout(T) : Typ. value of Vout

■Electrical characteristics (ELM95xxBxE)

Vout=2.7V(ELM9527BxE)

L=100μH, Cin=Cout=47μF, D=DB2J208, Vss=0V, Top=25°C

Parameter	Symbol	Condition	Min.	Typ.	Max.	Unit
Input voltage	Vin		0.9		7.0	V
Starting voltage	Vst	No load			0.9	V
Holding voltage	Vhold	Iout=1mA			0.7	V
Current consumption	Iss	Vin=1.5V, Iout=1mA		15	30	μA
Output voltage	Vout	Vin=1.5V, Iout=1mA	2.633	2.700	2.767	V
On-resistance of LX switch	Ron	Vout=Vout(T)×0.95		0.6	1.1	Ω
Leakage current of LX pin	Ilxl	Vout=Vlx=7.0V			1.0	μA
Oscillating frequency	Fosc	Vout=Vout(T)×0.95	80	100	120	kHz
Maximum duty ratio	Duty	Vout=Vout(T)×0.95	70	77	85	%
Current limit of LX switch	Ilimit	Vout=Vout(T)×0.95		600		mA

* Vout(T) : Typ. value of Vout

ELM95xxxxE CMOS PWM step-up DC/DC converter

<http://www.elm-tech.com>

Vout=3.0V(ELM9530BxE)

L=100μH, Cin=Cout=47μF, D=DB2J208, Vss=0V, Top=25°C

Parameter	Symbol	Condition	Min.	Typ.	Max.	Unit
Input voltage	Vin		0.9		7.0	V
Starting voltage	Vst	No load			0.9	V
Holding voltage	Vhold	Iout=1mA			0.7	V
Current consumption	Iss	Vin=1.5V, Iout=1mA		18	32	μA
Output voltage	Vout	Vin=1.5V, Iout=1mA	2.925	3.000	3.075	V
On-resistance of LX switch	Ron	Vout=Vout(T)×0.95		0.6	1.1	Ω
Leakage current of LX pin	Ilxl	Vout=Vlx=7.0V			1.0	μA
Oscillating frequency	Fosc	Vout=Vout(T)×0.95	80	100	120	kHz
Maximum duty ratio	Duty	Vout=Vout(T)×0.95	70	77	85	%
Current limit of LX switch	Ilimit	Vout=Vout(T)×0.95		600		mA

* Vout(T) : Typ. value of Vout

Vout=3.3V(ELM9533BxE)

L=100μH, Cin=Cout=47μF, D=DB2J208, Vss=0V, Top=25°C

Parameter	Symbol	Condition	Min.	Typ.	Max.	Unit
Input voltage	Vin		0.9		7.0	V
Starting voltage	Vst	No load			0.9	V
Holding voltage	Vhold	Iout=1mA			0.7	V
Current consumption	Iss	Vin=1.5V, Iout=1mA		20	35	μA
Output voltage	Vout	Vin=1.5V, Iout=1mA	3.218	3.300	3.382	V
On-resistance of LX switch	Ron	Vout=Vout(T)×0.95		0.55	1.00	Ω
Leakage current of LX pin	Ilxl	Vout=Vlx=7.0V			1.0	μA
Oscillating frequency	Fosc	Vout=Vout(T)×0.95	80	100	120	kHz
Maximum duty ratio	Duty	Vout=Vout(T)×0.95	70	77	85	%
Current limit of LX switch	Ilimit	Vout=Vout(T)×0.95		600		mA

* Vout(T) : Typ. value of Vout

Vout=5.0V(ELM9550BxE)

L=100μH, Cin=Cout=47μF, D=DB2J208, Vss=0V, Top=25°C

Parameter	Symbol	Condition	Min.	Typ.	Max.	Unit
Input voltage	Vin		0.9		7.0	V
Starting voltage	Vst	No load			0.9	V
Holding voltage	Vhold	Iout=1mA			0.7	V
Current consumption	Iss	Vin=3.0V, Iout=1mA		35	55	μA
Output voltage	Vout	Vin=3.0V, Iout=1mA	4.875	5.000	5.125	V
On-resistance of LX switch	Ron	Vout=Vout(T)×0.95		0.45	0.80	Ω
Leakage current of LX pin	Ilxl	Vout=Vlx=7.0V			1.0	μA
Oscillating frequency	Fosc	Vout=Vout(T)×0.95	80	100	120	kHz
Maximum duty ratio	Duty	Vout=Vout(T)×0.95	70	77	85	%
Current limit of LX switch	Ilimit	Vout=Vout(T)×0.95		600		mA

* Vout(T) : Typ. value of Vout

ELM95xxxxE CMOS PWM step-up DC/DC converter

<http://www.elm-tech.com>

■ Marking

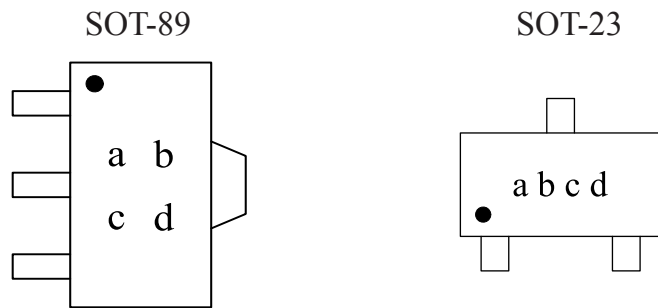

a, b : Represents Output voltage range and Package type and Switching frequency type

Symbol	Output voltage range (V)	Package	Switching frequency
5P	2.5~3.0	SOT-89	55kHz
5Q	2.5~3.0	SOT-89	100kHz
5R	3.1~5.5	SOT-89	55kHz
5S	3.1~5.5	SOT-89	100kHz
5T	2.5~3.0	SOT-23	55kHz
5U	2.5~3.0	SOT-23	100kHz
5V	3.1~5.5	SOT-23	55kHz
5W	3.1~5.5	SOT-23	100kHz

c : Represents Output voltage.

Symbol	Output voltage(V)		Symbol	Output voltage(V)	
1		3.1	F		4.6
2		3.2	G		4.7
3		3.3	H		4.8
4		3.4	J		4.9
5		3.5	K		5.0
6		3.6	L		5.1
7		3.7	M		5.2
8		3.8	N		5.3
9		3.9	P		5.4
0		4.0	Q	2.5	5.5
A		4.1	R	2.6	
B		4.2	S	2.7	
C		4.3	T	2.8	
D		4.4	U	2.9	
E		4.5	V	3.0	

d : Represents the assembly lot number
1~0, A~Z repeated (I,O,X excepted)

ELM95xxxxE CMOS PWM step-up DC/DC converter

<http://www.elm-tech.com>

External parts

To design DC/DC converter using ELM95 series, coil, diode, and capacitor are necessary.
(Refer to the standard circuit configuration.)

1) Coil

When choosing choke coil, please select that whose core is not magnetically saturated, DC resistance is low, and which has sufficient margin for rated current. ELM recommends to use inductance around 220 μ H for ELM995xxAxE, and ELM95xxBxE. For ELM95 series, ELM recommends following coil.

- SLF7045T (TDK corporation)

2) Diode

When choosing diode, please select that whose forward voltage is small, switching speed is high and which has sufficient margin for rated current.

For ELM95 series, ELM recommends schottky diodes.

3) Capacitor

When choosing capacitor, please select that which is generally used for smoothing power supply circuit, with comparatively large capacity, with small equivalent series resistance, and with large rated voltage.

For ELM95 series, ELM recommends ceramic capacitor, although Aluminum electrolytic and Tantalum capacitors also can be used. Under heavier load condition using small output capacitor, there might be cases that few hundred hertz wave motion will happen in output voltage waveform. Under such cases, ELM recommends to use capacitor with larger capacity. Examples are shown as follows. ELM recommends 47 μ F or larger for C_{out} and 47 μ F for C_{in} . On the other hand, under light load use ($I_{out} < 20\text{mA}$) only, it is possible to use smaller capacitors such as $C_{in} = C_{out} = 22\mu\text{F}$.

One of example of solution for large amplitude waveform with lower frequency are shown as follows:

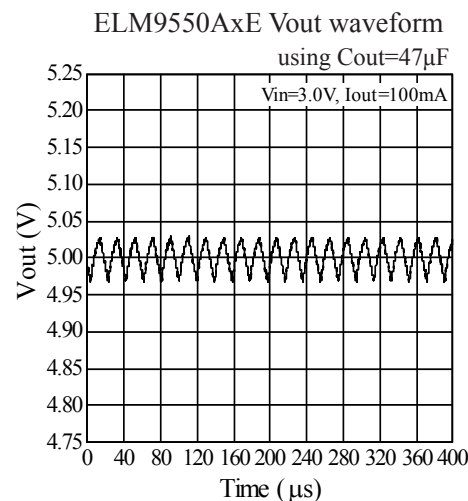
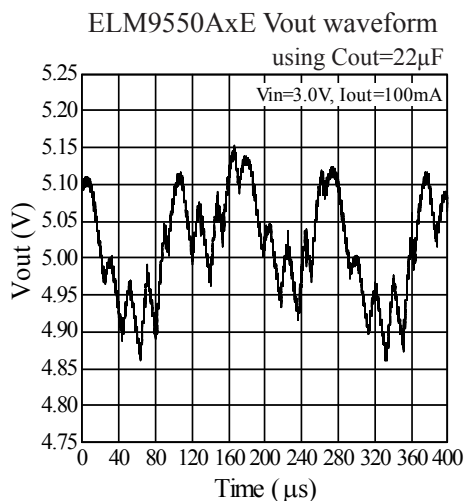

4) Remedies for noise

The DC/DC converter may cause electromagnetic noise due to switching of coil under large current. Solution is necessary especially when the IC is used in wireless devices. To reduce noise, this IC is designed in consideration of coil switching characteristics. The following methods are also effective to reduce noise.

- Use shield-type, or magnetic shield coil.
- Locate coil and diode to the LX terminal of IC as close as possible.
- Select ground wire as thick and short as possible.
- Connect ground wire of circuit to one point.

ELM95xxxxE CMOS PWM step-up DC/DC converter

<http://www.elm-tech.com>

■ Typical characteristics

- ELM9527AxE ($V_{out}=2.7V$, $F_{osc}=55kHz$, $Duty=60\%$) $L=220\mu H$, $C_{in}=C_{out}=47\mu F$, $D=DB2J208$, $T_{op}=25^{\circ}C$

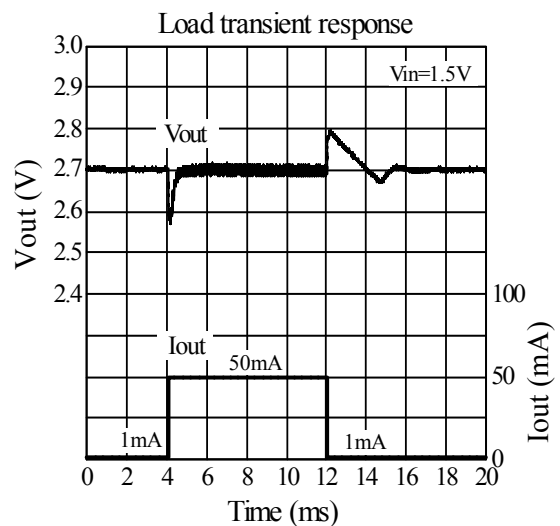
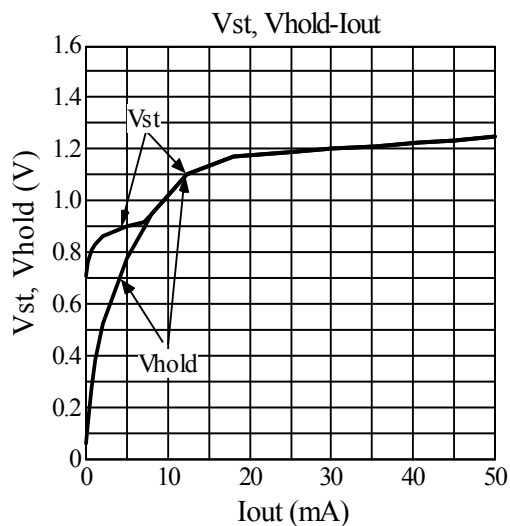
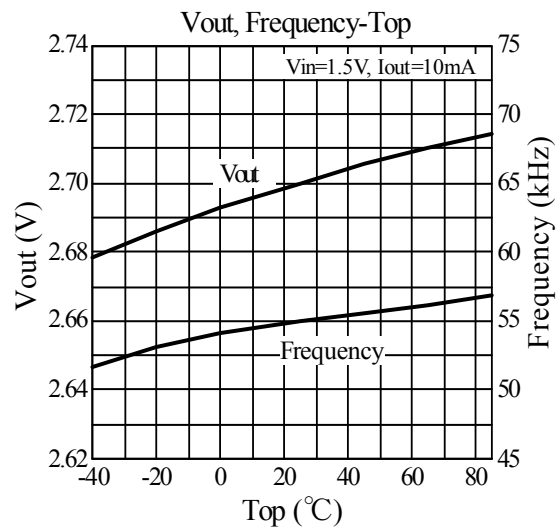
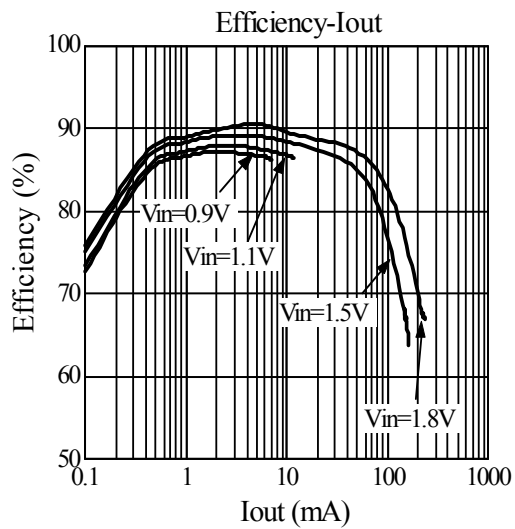
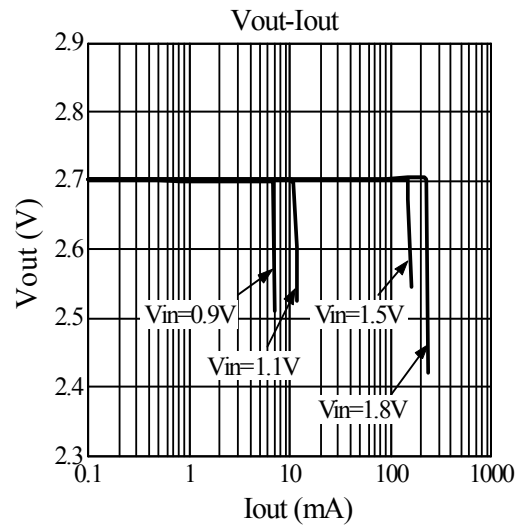
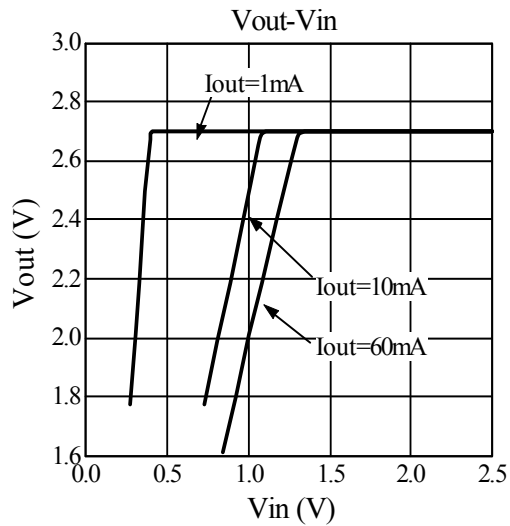

ELM95xxxxE CMOS PWM step-up DC/DC converter

<http://www.elm-tech.com>

- ELM9530AxE ($V_{out}=3.0V$, $F_{osc}=55kHz$, $Duty=60\%$) $L=220\mu H$, $C_{in}=C_{out}=47\mu F$, $D=DB2J208$, $Top=25^{\circ}C$

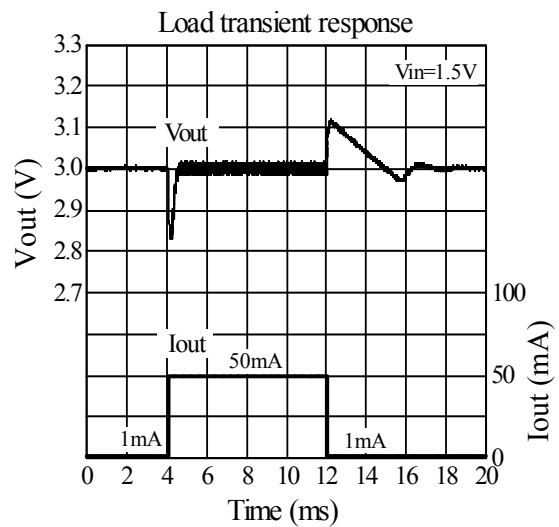
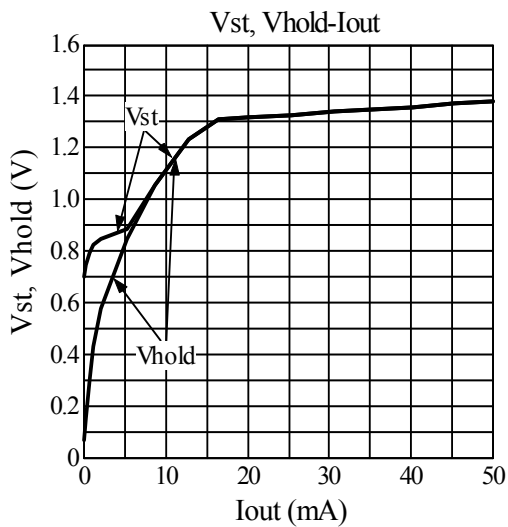
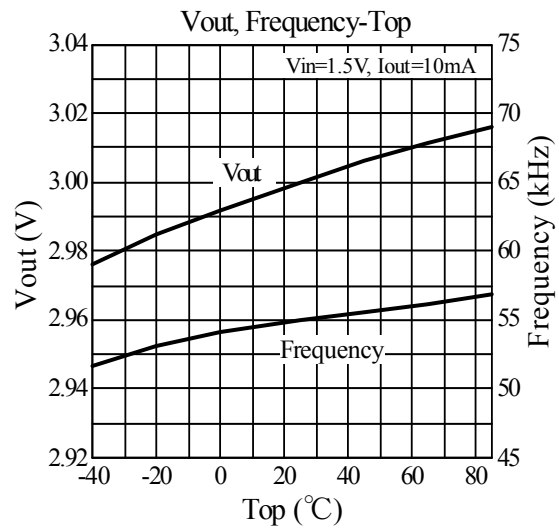
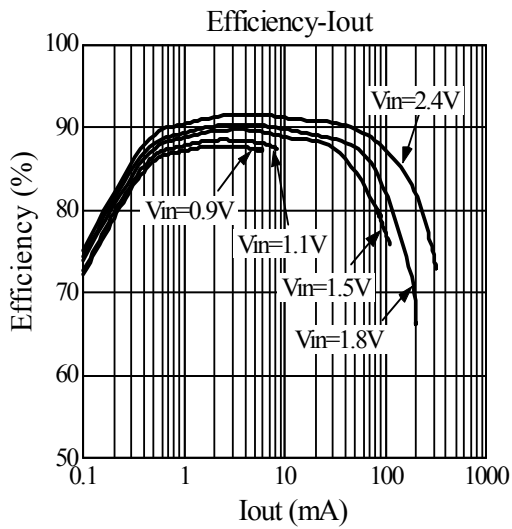
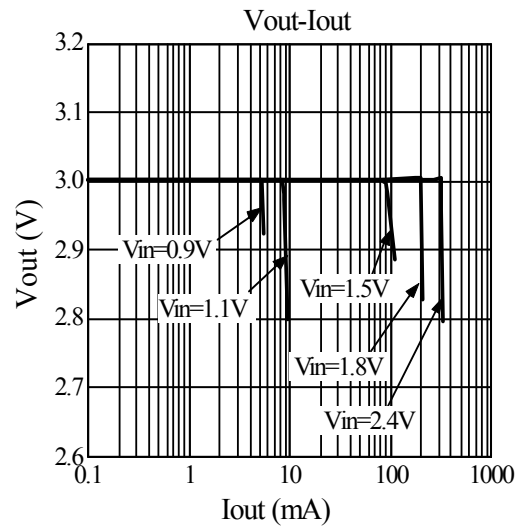
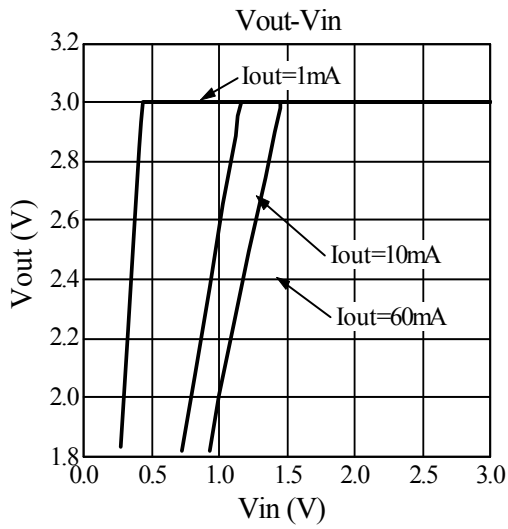

ELM95xxxxE CMOS PWM step-up DC/DC converter

<http://www.elm-tech.com>

- ELM9533AxExE ($V_{out}=3.3V$, $F_{osc}=55kHz$, $Duty=60\%$) $L=220\mu H$, $C_{in}=C_{out}=47\mu F$, $D=DB2J208$, $Top=25^{\circ}C$

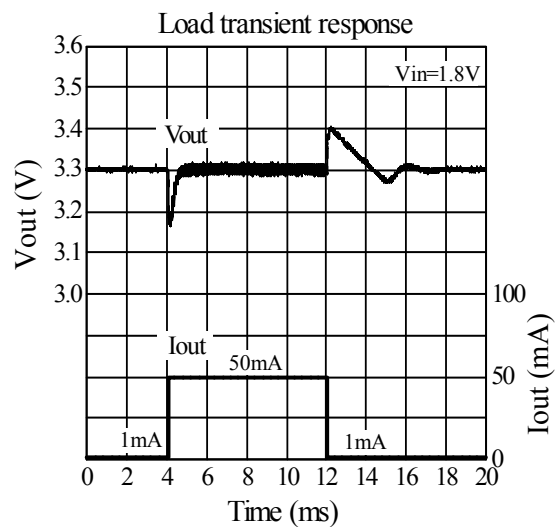
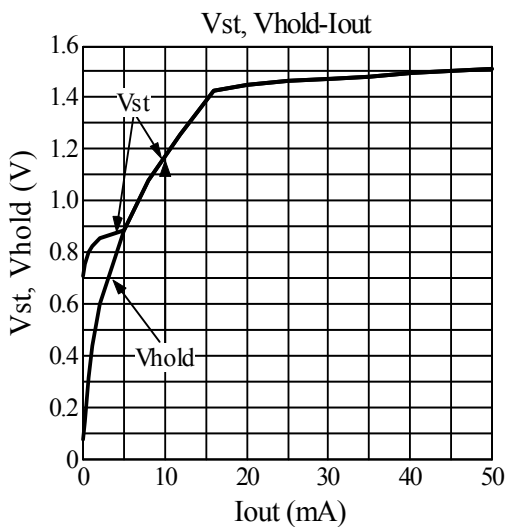
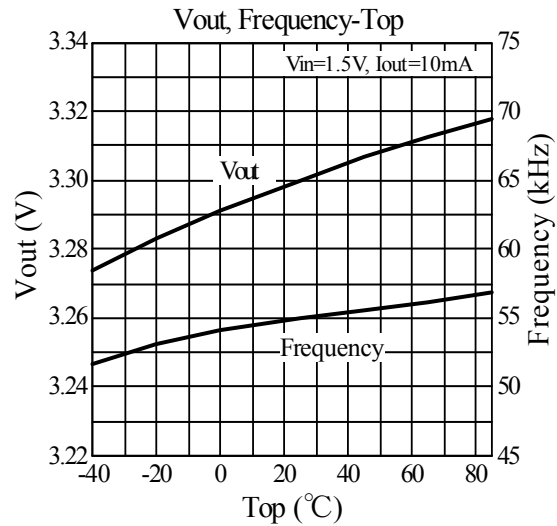
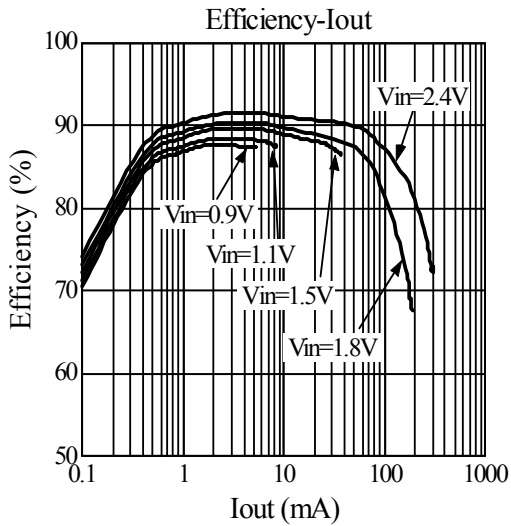
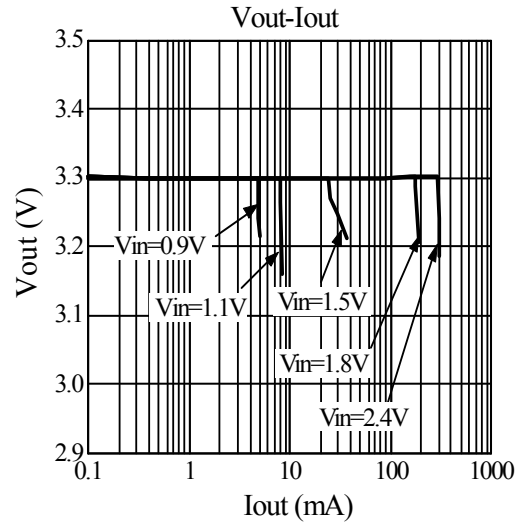
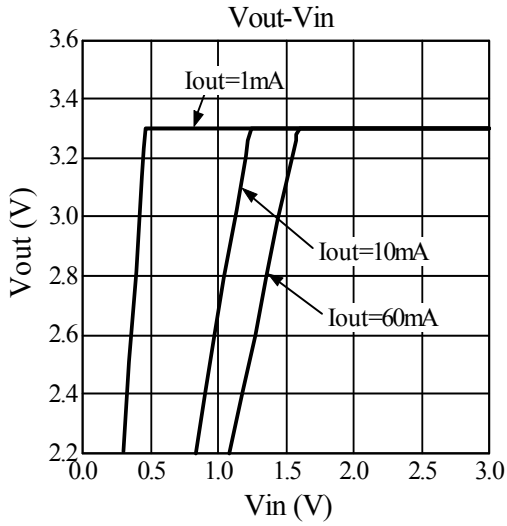

ELM95xxxxE CMOS PWM step-up DC/DC converter

<http://www.elm-tech.com>

- ELM9550AxE ($V_{out}=5.0V$, $F_{osc}=55kHz$, $Duty=60\%$) $L=220\mu H$, $C_{in}=C_{out}=47\mu F$, $D=DB2J208$, $Top=25^{\circ}C$

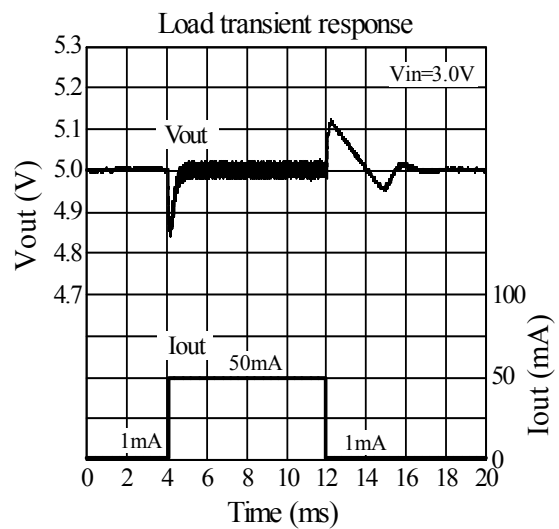
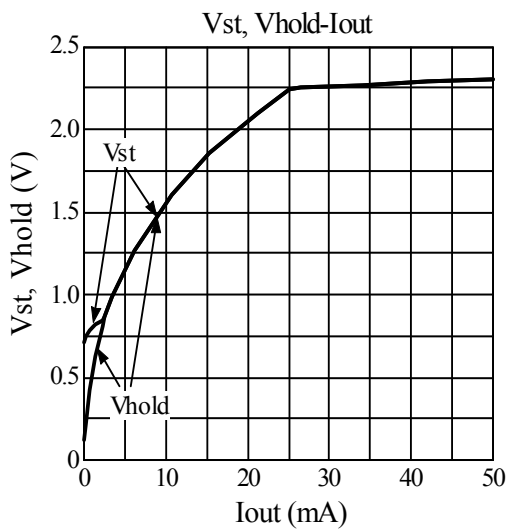
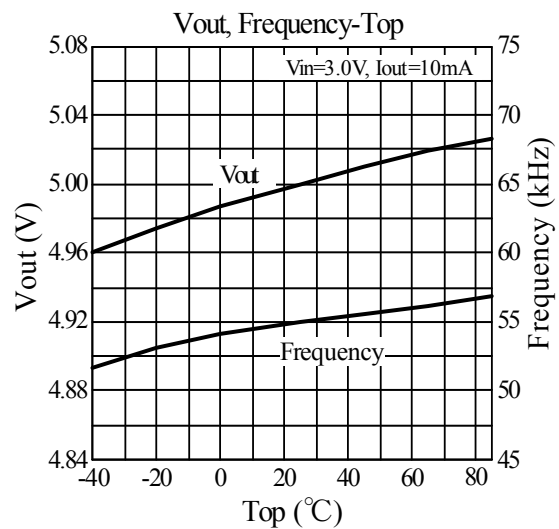
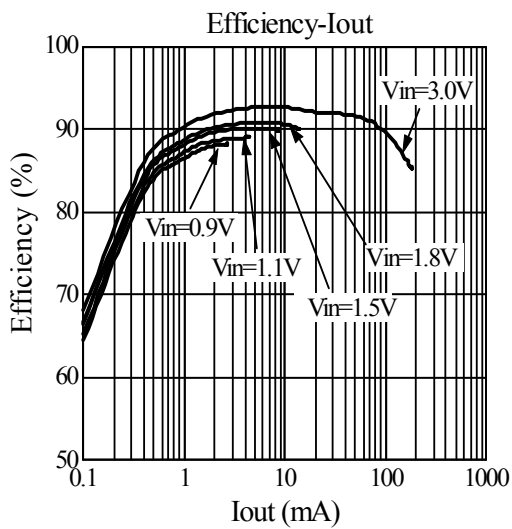
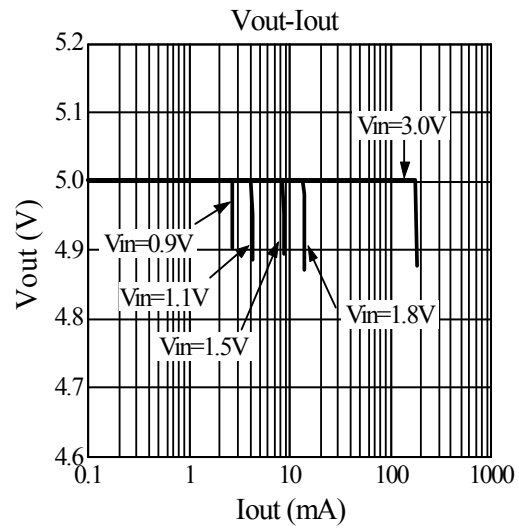
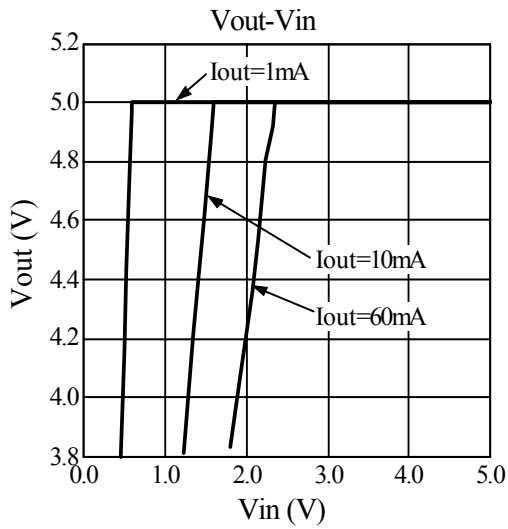

ELM95xxxxE CMOS PWM step-up DC/DC converter

<http://www.elm-tech.com>

- ELM9527BxE ($V_{out}=2.7V$, $F_{osc}=100kHz$, $Duty=77%$) $L=100\mu H$, $C_{in}=C_{out}=47\mu F$, $D=DB2J208$, $Top=25^{\circ}C$

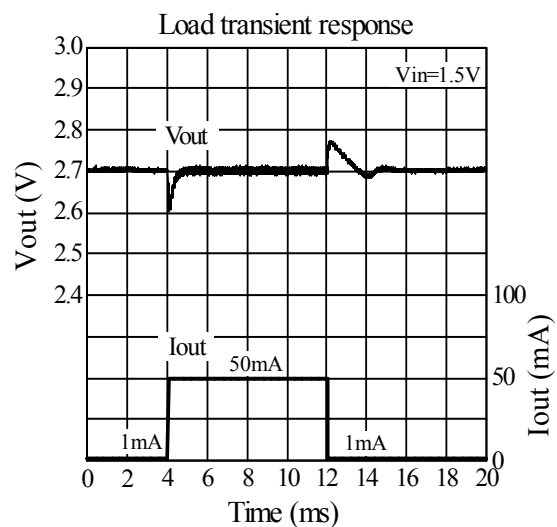
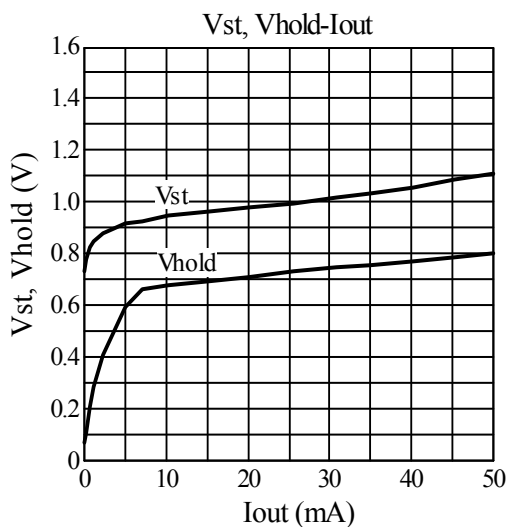
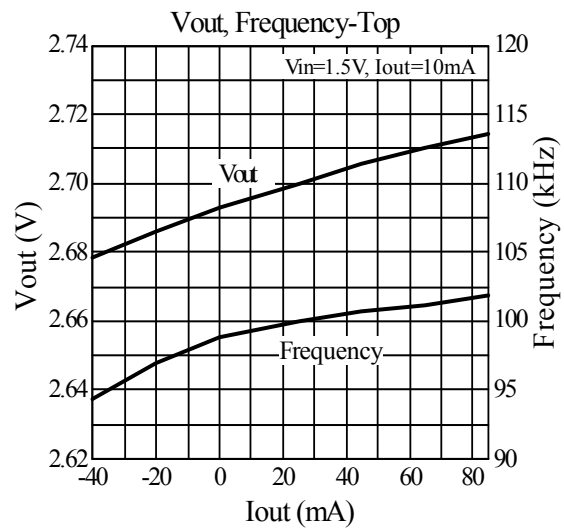
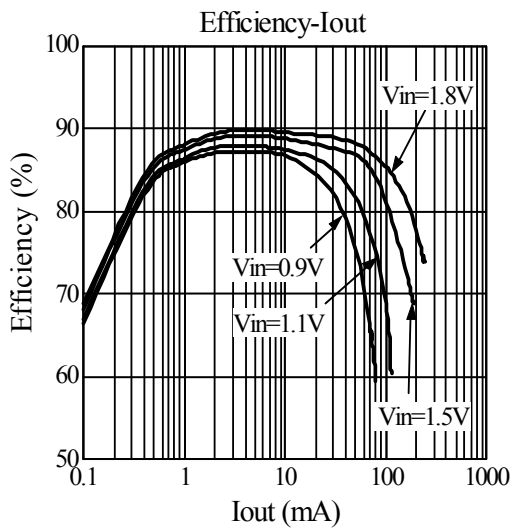
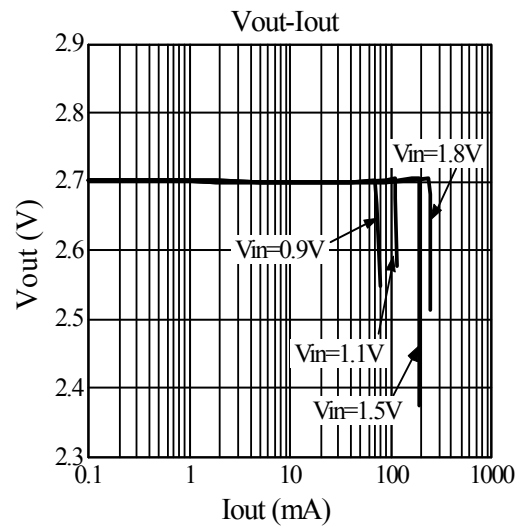
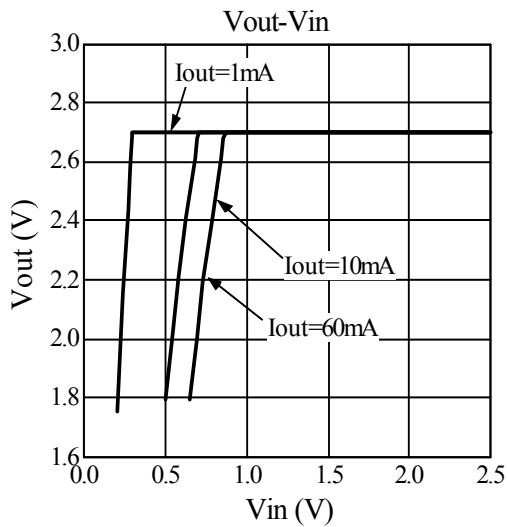

ELM95xxxxE CMOS PWM step-up DC/DC converter

<http://www.elm-tech.com>

- ELM9530BxE ($V_{out}=3.0V$, $F_{osc}=100kHz$, $Duty=77%$) $L=100\mu H$, $C_{in}=C_{out}=47\mu F$, $D=DB2J208$, $Top=25^{\circ}C$

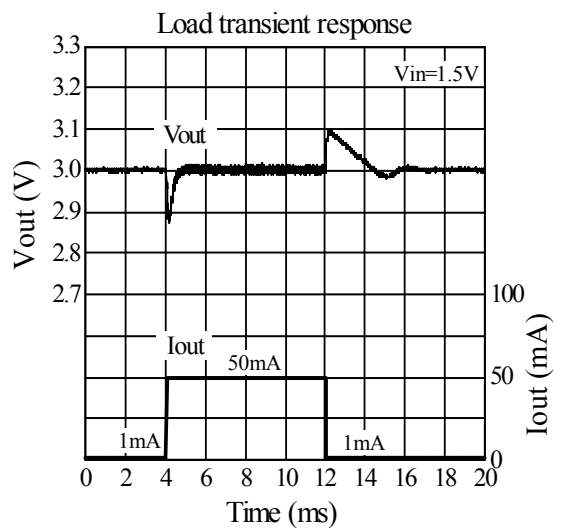
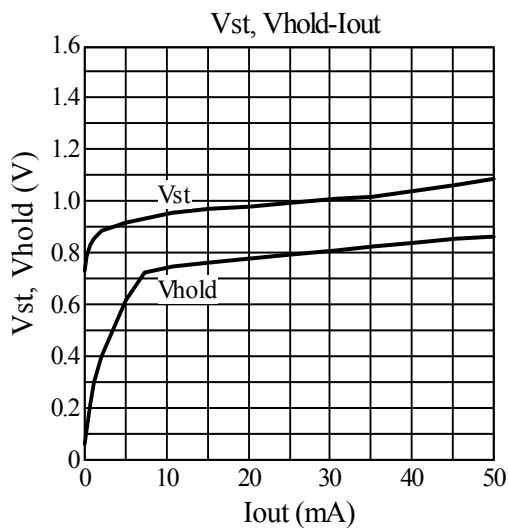
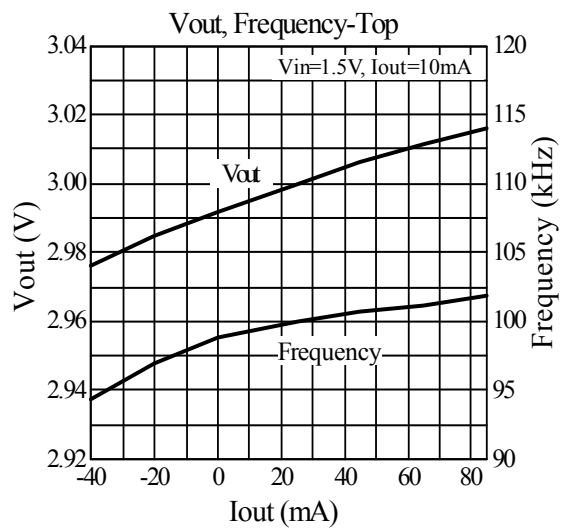
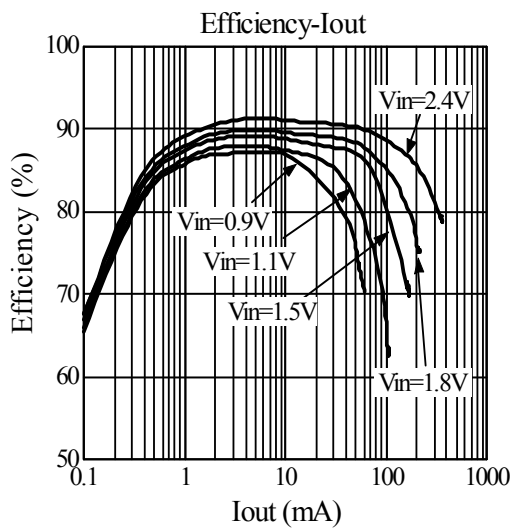
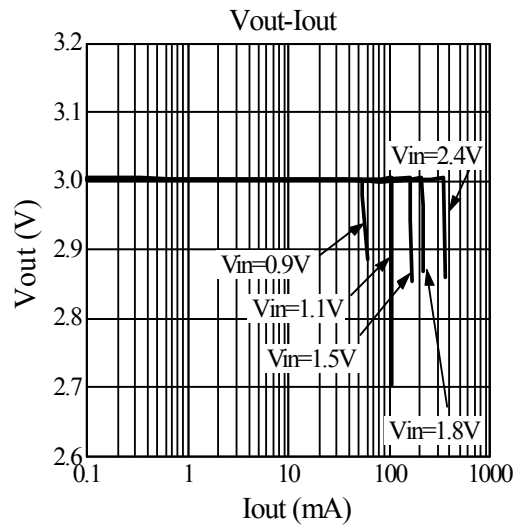
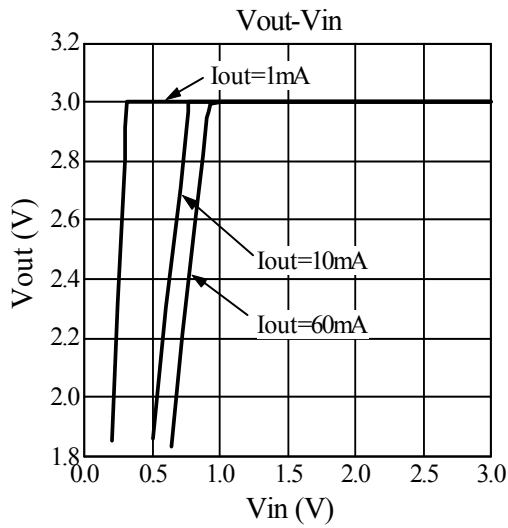

ELM95xxxxE CMOS PWM step-up DC/DC converter

<http://www.elm-tech.com>

- ELM9533BxE ($V_{out}=3.3V$, $F_{osc}=100kHz$, $Duty=77%$) $L=100\mu H$, $C_{in}=C_{out}=47\mu F$, $D=DB2J208$, $Top=25^{\circ}C$

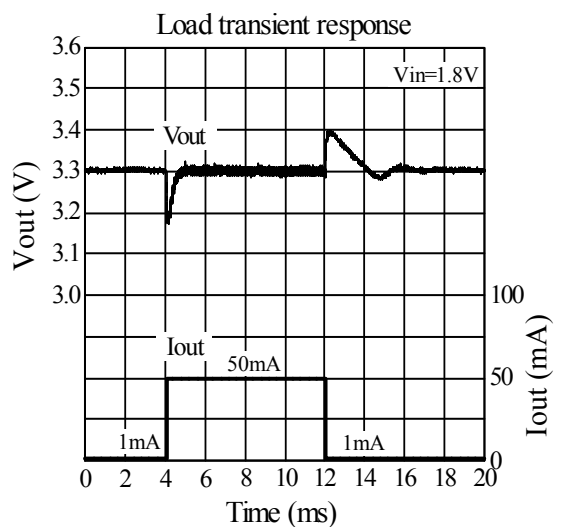
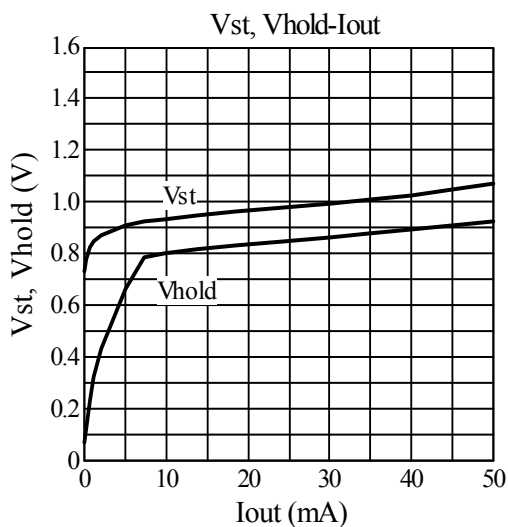
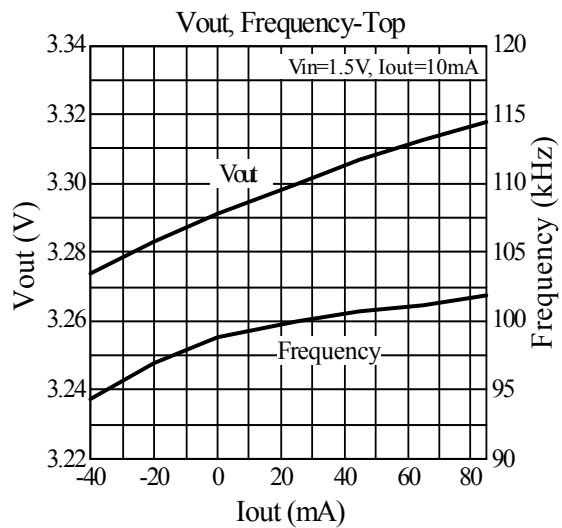
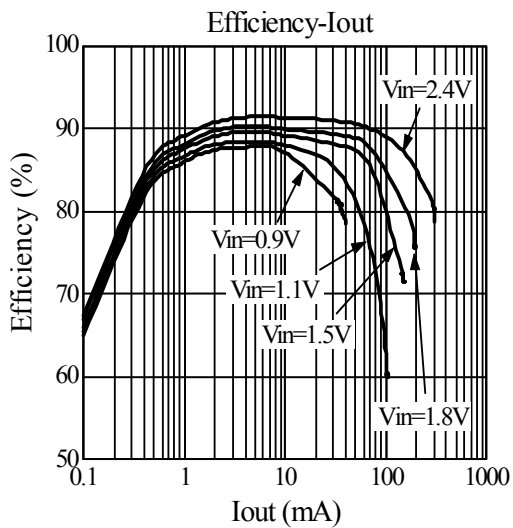
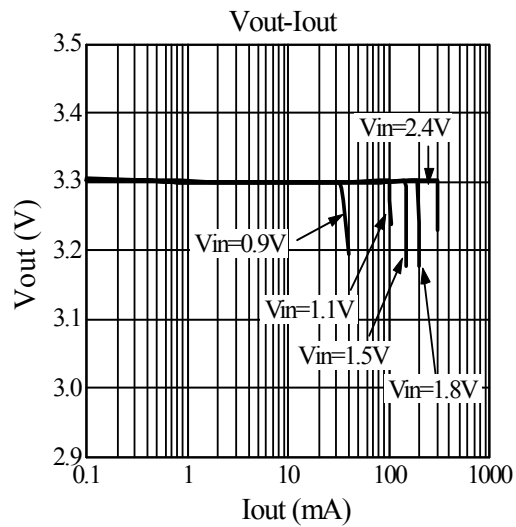
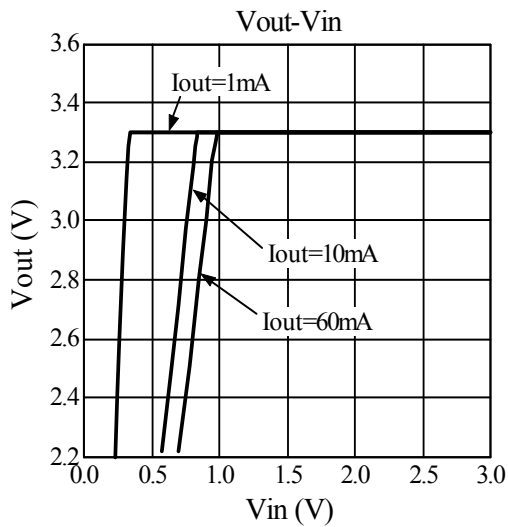

ELM95xxxxE CMOS PWM step-up DC/DC converter

<http://www.elm-tech.com>

- ELM9550BxE ($V_{out}=5.0V$, $F_{osc}=100kHz$, $Duty=77%$) $L=100\mu H$, $C_{in}=C_{out}=47\mu F$, $D=DB2J208$, $Top=25^{\circ}C$

