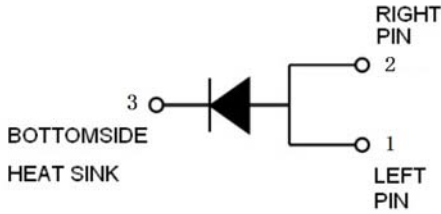

## 20 AMPS LOW VF SCHOTTKY BARRIER RECTIFIER

<p><b>20U10L</b></p> <p><b>Features:</b></p> <ul style="list-style-type: none"> <li><input type="checkbox"/> High current capacity, low forward voltage.</li> <li><input type="checkbox"/> Excellent high temperature stability.</li> <li><input type="checkbox"/> Low power loss, high efficiency</li> <li><input type="checkbox"/> High forward surge capacity.</li> <li><input type="checkbox"/> RoHS compliant, and Halogen free.</li> </ul>	<p>TO-277</p>  
--	---

**Absolute Maximum Ratings** (Ta=25°C unless otherwise noted)

Characteristic	Symbol	Test Condition	Min.	Typ.	Max.	Unit
Recurrent Peak Reverse Voltage	$V_{RRM}$	$I_R=0.5mA$	100	-	-	V
Average Forward Current	$I_{F(AV)}$	$V_R=100V@T_j=25^\circ C$	-	20	-	A
Peak Forward Surge Current, 8.3ms single half sine-wave	$I_{FSM}$	$V_R=100V@T_j=25^\circ C$	-	-	200	A
Forward Voltage(Note1)	$V_F$	$I_F=20A$	-	0.685	0.720	V
Reverse Leakage Current(Note1)	$I_R$	$V_R=100V@T_j=25^\circ C$	-	-	0.1	mA
		$V_R=100V@T_j=100^\circ C$	-	-	20	
Operating Junction Temperature	$T_j$	-	-	-	150	°C
Storage Temperature Range	$T_{stg}$	-	-40	-	150	
Thermal Resistance(Note2)	$R_{th(JA)}$	-	-	31	-	°C/W

Note 1: Pulse test width PW=300usec. 1%duty cycle

Note 2: Polymide PCB, 2oz. copper. Cathode pad dimensions 18.8\*14.4mm. Anode pad dimensions 5.6\*14.1mm

20 AMPS LOW VF SCHOTTKY BARRIER RECTIFIER

Typical Characteristics

RATING AND CHARACTERISTIC CURVES

FIG. 1- FORWARD CURRENT DERATING CURVE

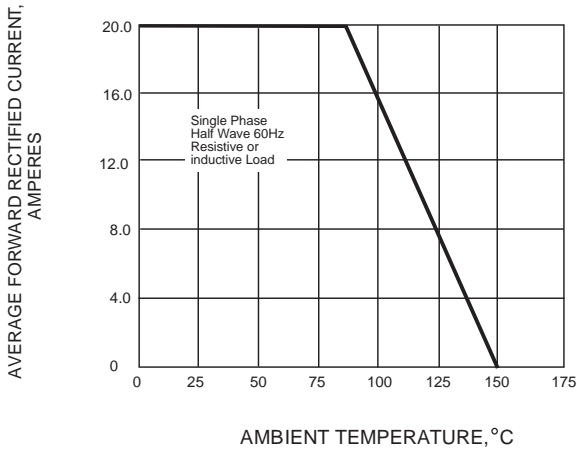

FIG. 2-MAXIMUM NON-REPETITIVE PEAK FORWARD SURGE CURRENT

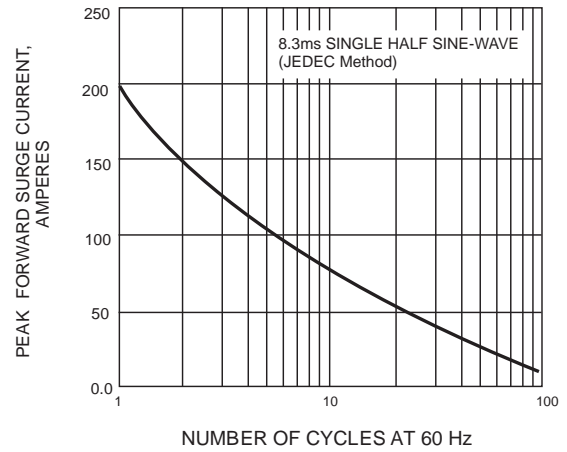

FIG. 3-TYPICAL INSTANTANEOUS FORWARD CHARACTERISTICS

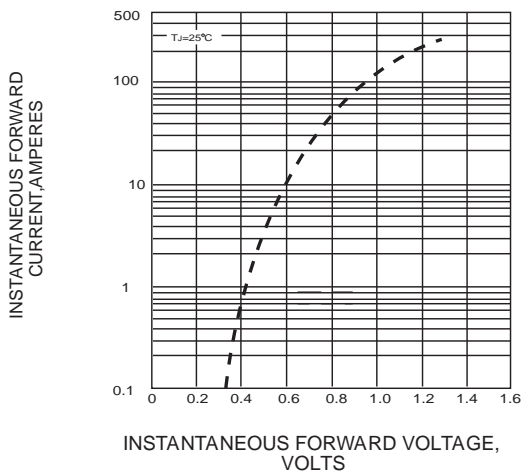
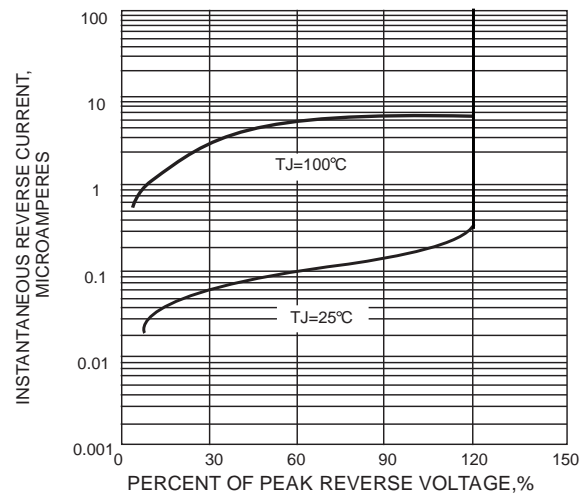

FIG. 4-TYPICAL REVERSE CHARACTERISTICS



## 20 AMPS LOW VF SCHOTTKY BARRIER RECTIFIER

**Package Dimension**

TO-277

Units: mm

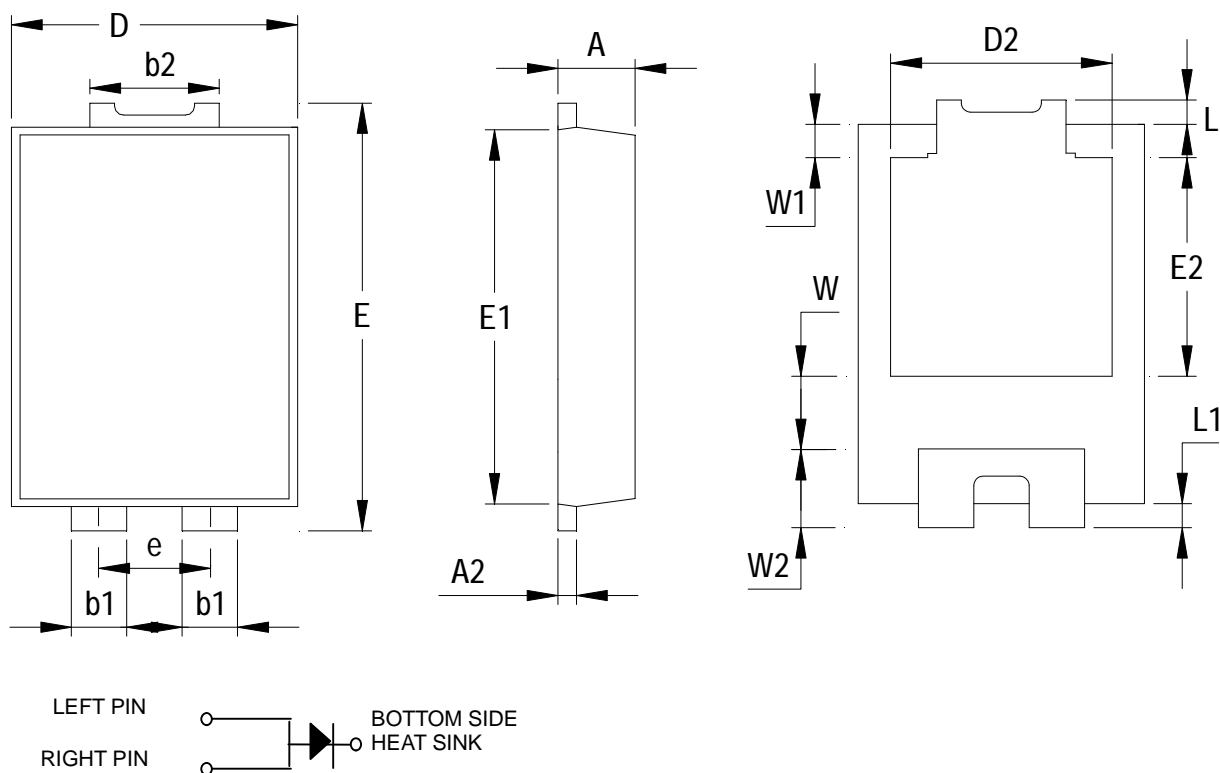

NO	Dimensions	NO	Dimensions
A	1.25±0.05	e	1.8Typ
A2	0.30±0.02	E1	6.25±0.05
b1	0.9±0.05	E2	3.6±0.2
b2	2.1±0.05	L/L1	0.4±0.05
D	4.65±0.05	W	1.2±0.2
D2	3.60Typ	W1	0.55±0.15
E	7.05±0.1	W2	1.3±0.2
<b>All Dimensions in mm</b>			