

SLD8S Series

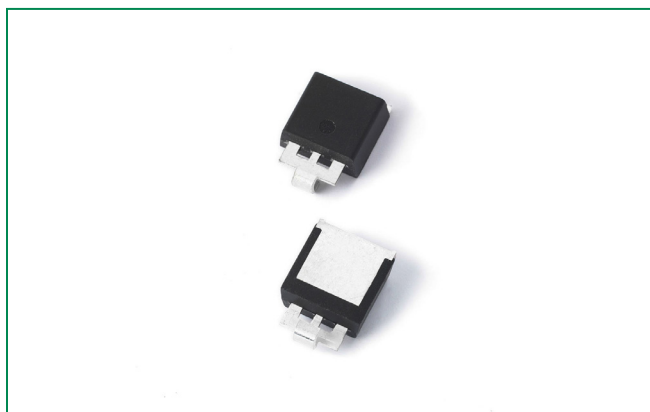

Agency Approvals

AGENCY	AGENCY FILE NUMBER
	E230531

Maximum Ratings and Thermal Characteristics (T_A = 25°C unless otherwise noted)

Parameter	Symbol	Value	Unit
Peak Pulse Power Dissipation 1. 10ms x 150ms test waveform 2. 10µs x 1000µs test waveform	P _{PPM}	2200	W
		7000	W
Power dissipation on infinite heatsink at T _C = 25 °C	P _D	8.0	W
Maximum Instantaneous Forward Voltage at 100A for Unidirectional only	V _F	1.8	V
Peak forward surge current 8.3ms single half sine-wave	I _{FSM}	1000	A
Operating Junction and Storage Temperature Range	T _J , T _{STG}	-55 to 175	°C
Typical Thermal Resistance Junction to case	R _{θJC}	0.9	°C/W

Functional Diagram

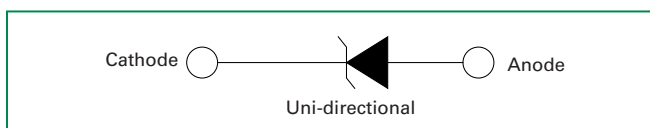

Description

The SLD8S Series is SMTO-263 packaged with leaded modification and is designed to provide precision overvoltage protection for sensitive electronics.

Features

- AEC-Q101 qualified
- SMTO-263 package, and foot print is compatible to industrial popular DO-218AB package
- Meet ISO7637-2 5a/5b protection and ISO16750 load dump test (refer to APP note for details)
- $V_{BR} @ T_J = V_{BR} @ 25^\circ C \times (1 + \alpha T \times (T_J - 25))$ (α : Temperature Coefficient, typical value is 0.1%)
- Glass passivated chip junction in modified TO-263 package
- IEC-61000-4-2 ESD 30kV(Air), 30kV (Contact)
- ESD protection of data lines in accordance with IEC 61000-4-2
- EFT protection of data lines in accordance with IEC 61000-4-4
- Fast response time: typically less than 1.0ps from 0 Volts to BV min
- Excellent clamping capability
- Low incremental surge resistance
- Plastic package is flammability rated V-0 per Underwriters Laboratories
- Meet MSL level 1, per J-STD-020, LF maximum peak of 260°C
- For surface mounted applications to optimize board space
- Low profile package
- High temperature to reflow soldering guaranteed: 260°C/10sec at terminals
- Matte tin lead-free plated
- Halogen free and RoHS compliant
- Pb-free E3 means 2nd level interconnect is Pb-free and the terminal finish material is tin (Sn) (IPC/JEDEC J-STD-609A.01)

Applications

Designed to protect sensitive electronics from:

- Inductive Load Switching
- Alternator Load Dump

Electrical Characteristics ($T_A=25^\circ\text{C}$ unless otherwise noted)

Part Number (Uni)	Breakdown Voltage V_{BR} @ I_T (V)		Test Current I_T (mA)	Reverse Stand off Voltage V_R (Volts)	Maximum Reverse Leakage I_R @ V_R (μA)	$T_J=150^\circ\text{C}$ Max. Reverse Leakage I_R @ V_R (μA)	Maximum Peak Pulse Surge Current I_{PP} (A)	Maximum Clamping Voltage V_C @ I_{PP} (V)	Agency Approval 
	MIN	MAX							
SLD8S12A	13.3	14.7	5.0	12	10	50	352	19.9	X
SLD8S13A	14.4	15.9	5.0	13	10	50	326	21.5	X
SLD8S14A	15.6	17.2	5.0	14	10	50	301	23.2	X
SLD8S15A	16.7	18.5	5.0	15	10	50	286	24.4	X
SLD8S16A	17.8	19.7	5.0	16	2.0	50	269	26.0	X
SLD8S17A	18.9	20.9	5.0	17	2.0	50	253	27.6	X
SLD8S18A	20.0	22.1	5.0	18	2.0	50	240	29.2	X
SLD8S20A	22.2	24.5	5.0	20	2.0	50	216	32.4	X
SLD8S22A	24.4	26.9	5.0	22	2.0	50	197	35.5	X
SLD8S24A	26.7	29.5	5.0	24	2.0	50	180	38.9	X
SLD8S26A	28.9	31.9	5.0	26	2.0	50	167	42.1	X
SLD8S27A	29.9	33.1	5.0	27	2.0	50	160	43.6	X
SLD8S28A	31.1	34.4	5.0	28	2.0	50	154	45.4	X
SLD8S30A	33.3	36.8	5.0	30	2.0	50	144	48.4	X
SLD8S33A	36.7	40.6	5.0	33	2.0	50	132	53.3	X
SLD8S36A	40.0	44.2	5.0	36	2.0	50	121	58.1	X
SLD8S40A	44.4	49.1	5.0	40	2.0	50	108	64.5	X
SLD8S43A	47.8	52.8	5.0	43	2.0	50	101	69.4	X
SLD8S48A	53.3	58.9	5.0	48	2.0	50	89.7	77.4	X
SLD8S57A	63.8	69.9	5.0	57	2.0	50	75.5	92.7	X

Notes:

- V_{BR} measured after I_T applied for 300 μs , I_T = square wave pulse or equivalent.
- Surge current waveform per 10 μs x 1000 μs exponential wave and derated per Fig. 2
- All terms and symbols are consistent with ANSI/IEEE C62.35.

Load Dump Test Wave Form

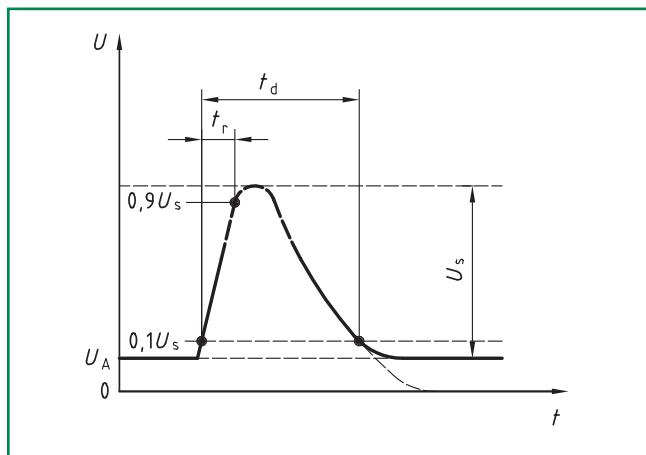

Note: LF use $t_d=400\text{ms}$ for 12V system test; $t_d=350\text{ms}$ for 24V system

Parameter	12V system	24V system
U_s	65v to 87V	123V to 174V
R_i	0.5 Ω to 4 Ω	1 Ω to 8 Ω
t_d	40 ms to 400 ms	100 ms to 350 ms
t_r	$(10^{-0.5})\text{ms}$	

I-V Curve Characteristics

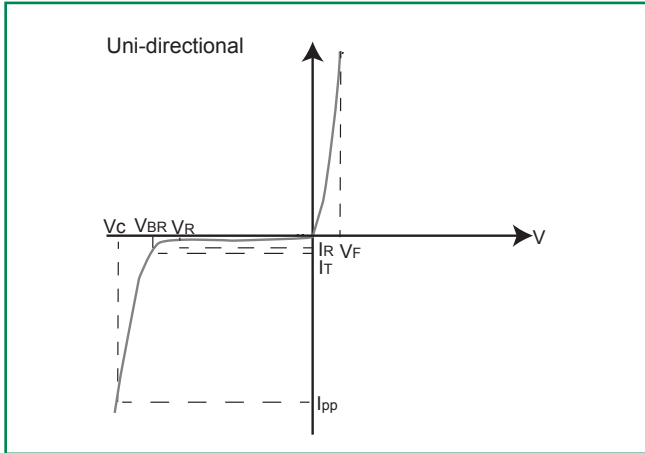

- P_{PPM} Peak Pulse Power Dissipation** – Max power dissipation
- V_R Stand-off Voltage** – Maximum voltage that can be applied to the TVS without operation
- V_{BR} Breakdown Voltage** – Maximum voltage that flows though the TVS at a specified test current (I_T)
- V_C Clamping Voltage** – Peak voltage measured across the TVS at a specified I_{ppm} (peak impulse current)
- I_R Reverse Leakage Current** – Current measured at V_R
- V_F Forward Voltage Drop for Uni-directional**

Ratings and Characteristic Curves ($T_A=25^\circ\text{C}$ unless otherwise noted)

Figure 1 - Peak Pulse Current Rating Curve

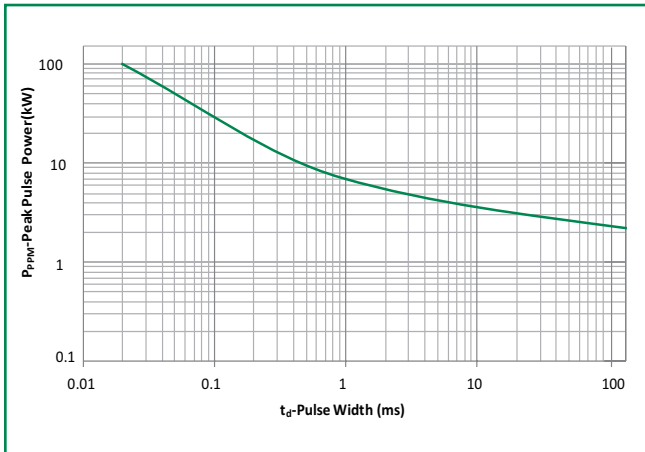

Figure 2 - Peak Pulse Power Derating Curve

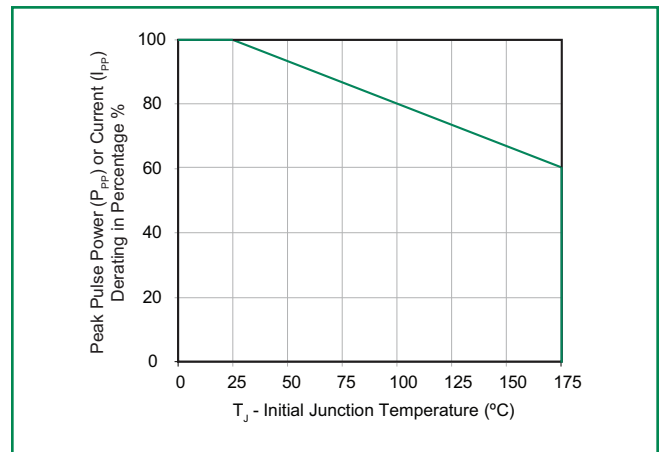

Figure 3 - Typical Transient Thermal Impedance

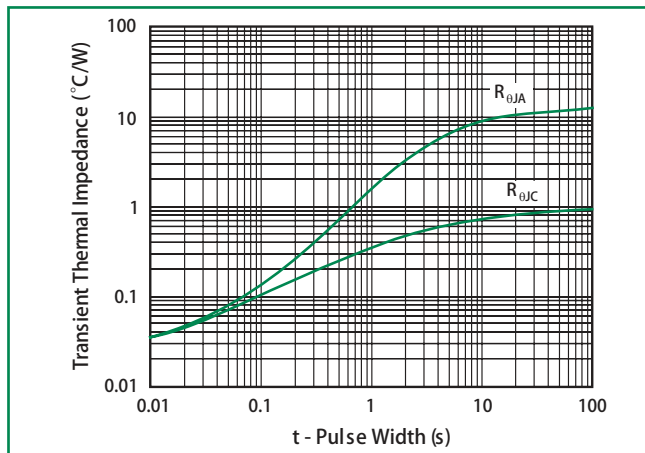

Figure 4 - Typical SOA Chart

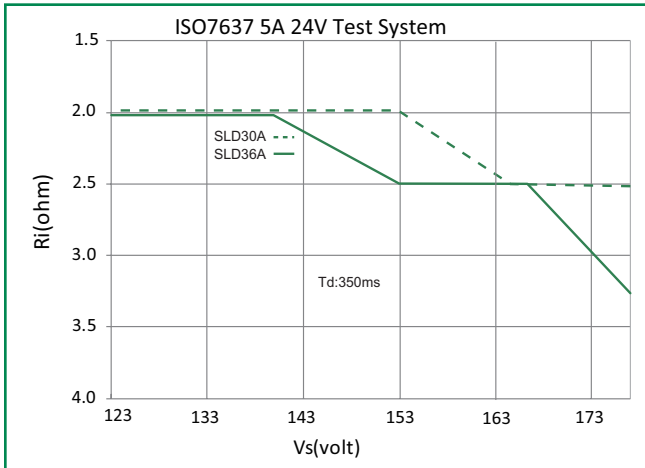
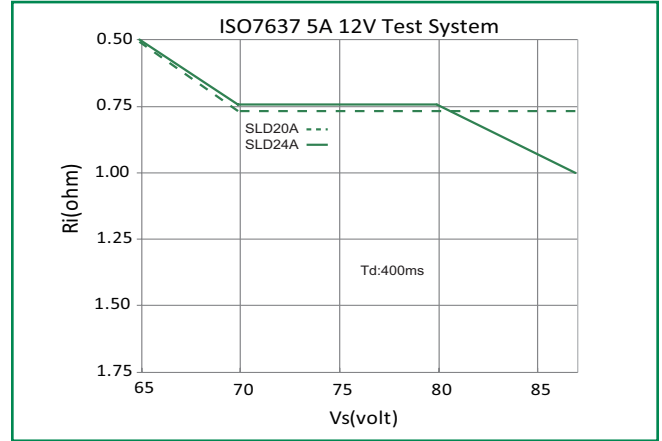
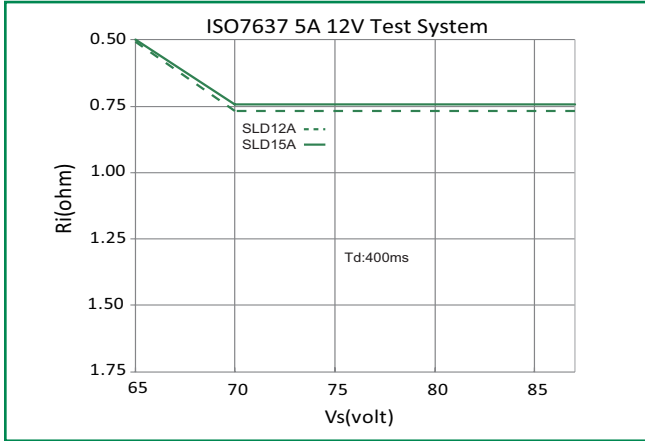
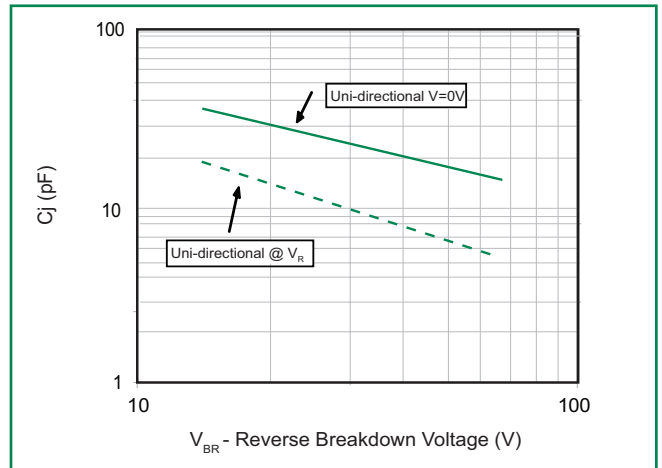

Figure 5 - Typical Junction Capacitance



Note: SOA (Safe Operation Area) refer to the area which below the curve line and refer to APP note for details.

Soldering Parameters

Reflow Condition		Pb – Free assembly
Pre Heat	- Temperature Min ($T_{s(min)}$)	150°C
	- Temperature Max ($T_{s(max)}$)	200°C
	- Time (min to max) (t_s)	60 – 180 secs
Average ramp up rate (Liquidus Temp) (T_L) to peak		5°C/second max
$T_{s(max)}$ to T_L - Ramp-up Rate		5°C/second max
Reflow	- Temperature (T_L) (Liquidus)	217°C
	- Time (min to max) (T_S)	60 – 150 seconds
Peak Temperature (T_p)		260 ^{+0/-5} °C
Time within 5°C of actual peak Temperature (t_p)		20 – 40 seconds
Ramp-down Rate		5°C/second max
Time 25°C to peak Temperature (T_p)		8 minutes Max.
Do not exceed		260°C

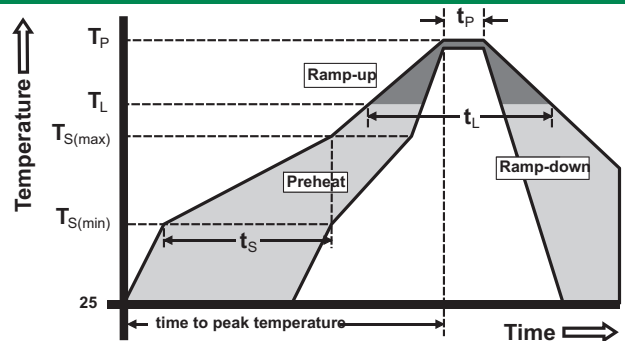

Physical Specifications

Terminal Finish	100% Matte Tin-plated
Body Material	UL recognized epoxy meeting flammability classification 94V-0
Lead Material	Copper Alloy

Environmental Specifications

High Temp. Storage	JESD22-A103
HTRB	JESD22-A108
Temperature Cycling	JESD22-A104
MSL	JEDEC-J-STD-020, LEVEL 1
H3TRB	JESD22-A101
RSH	JESD22-A111

Dimensions

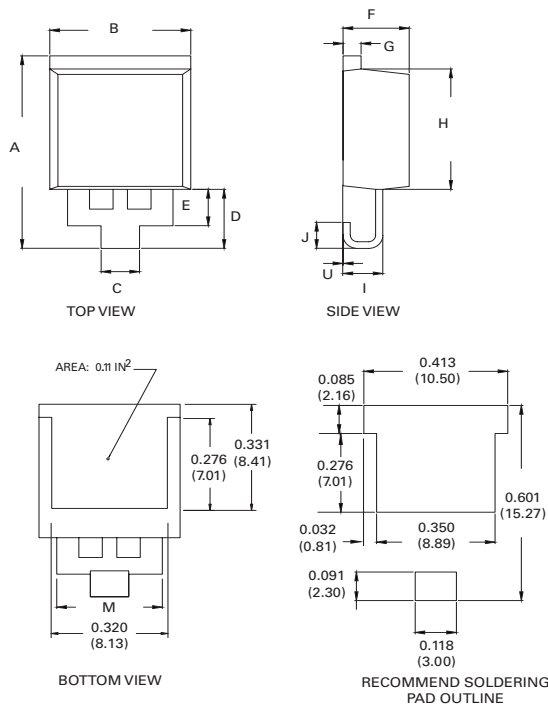

Dimensions	Inches		Millimeters	
	Min	Max	Min	Max
A	0.568	0.600	14.44	15.24
B	0.380	0.420	9.65	10.67
C	0.098	0.114	2.50	2.90
D	0.169	0.189	4.30	4.80
E	0.102	0.118	2.60	3.00
F	0.178	0.188	4.52	4.78
G	0.045	0.060	1.14	1.52
H	0.360	0.370	9.14	9.40
I	0.106	0.122	2.69	3.09
J	0.069	0.089	1.75	2.25
M	0.284	0.300	7.22	7.62
U	0	0.010	0	0.25

Part Numbering System

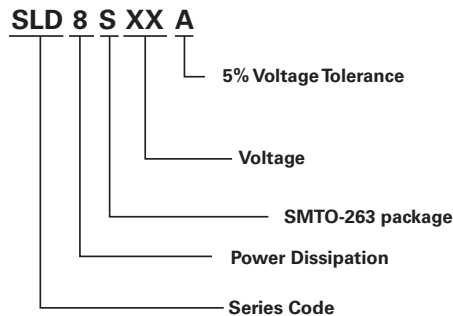

Part Marking System

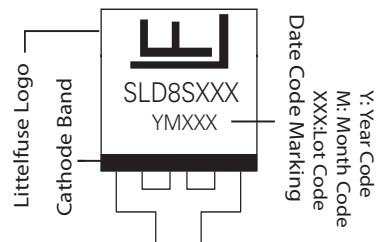

Packaging

Part Number	Component Package	Quantity	Packaging Option
SLD8SxxA	SMT0-263	500	Embossed Carrier

SMT0-263 Embossed Carrier Reel Pack (RP) Specifications

Meets all EIA-481-2 Standards

