

Xinger®

Ultra Low Profile 0805 Power Divider 75Ω to 75Ω

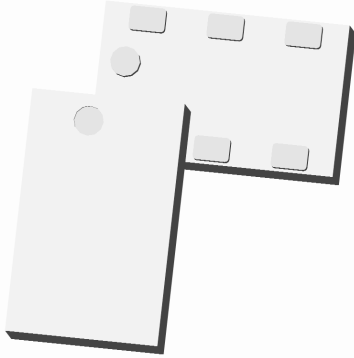

Description

The PD0922J7575D2 is a low profile, sub-miniature Wilkinson power divider in an easy to use surface mount package and is ideal for high volume manufacturing while delivering higher performances than traditional printed and lumped element solutions. It has been designed for the following markets: DVB-S, GSM, DCS, PCS, WCDMA, GPS, 802.11a+g, Bluetooth, and Zigbee USA.

The PD0922J7575D2 is matched to 75Ω and has a height profile of 0.8 mm. A two section Wilkinson design results in increased isolation performance. Two external resistors are required for operation. Components are available on tape and reel for high volume manufacturing pick and place.

All Xinger components are constructed from ceramic filled PTFE composites which possess excellent electrical and mechanical stability having X and Y thermal coefficient of expansion (CTE) of 17 ppm/°C.

Detailed Electrical Specifications: Specifications subject to change without notice.

Features:	Parameter	ROOM (25°C)			Unit
		Min.	Typ.	Max	
<ul style="list-style-type: none"> • 950 – 2150 MHz • 16 dB Isolation (output ports) • Good Return Loss • 0.8mm Height Profile • 75Ω Outputs/Inputs • External resistors required • Low Insertion Loss • Surface Mountable • Tape & Reel • Non-conductive Surface • RoHS Compliant 	Frequency	950		2150	MHz
	Input Port Impedance		75		Ω
	Output Port Impedance		75		Ω
	Return Loss	9.5	11		dB
	Insertion Loss*		0.8	1.0	dB
	Amplitude Balance		0.4	0.7	dB
	Phase Balance		2	3	Degrees
	Isolation (Output Ports)	14	16		dB
	Power Handling			2	Watts
	Operating Temperature	-55		+85	°C

* Insertion Loss stated at room temperature (Insertion Loss is approximately 0.1 dB higher at +85 °C)

Outline Drawing

Top View (Near-side)

Orientation Marker Denotes Pin Location

Side View

Bottom View (Far-side)

Orientation Marker Denotes Pin Location

Pin	Designation
1	Output 1
2	Input
3	Mid 2
4	Mid 1
5	GND
6	Output 2

Dimensions are in Inches [Millimeters]
Mechanical Outline

Tolerances are Non-Cumulative

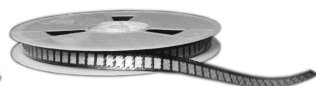

Typical Broadband Performance: 500 MHz. to 8.0 GHz.

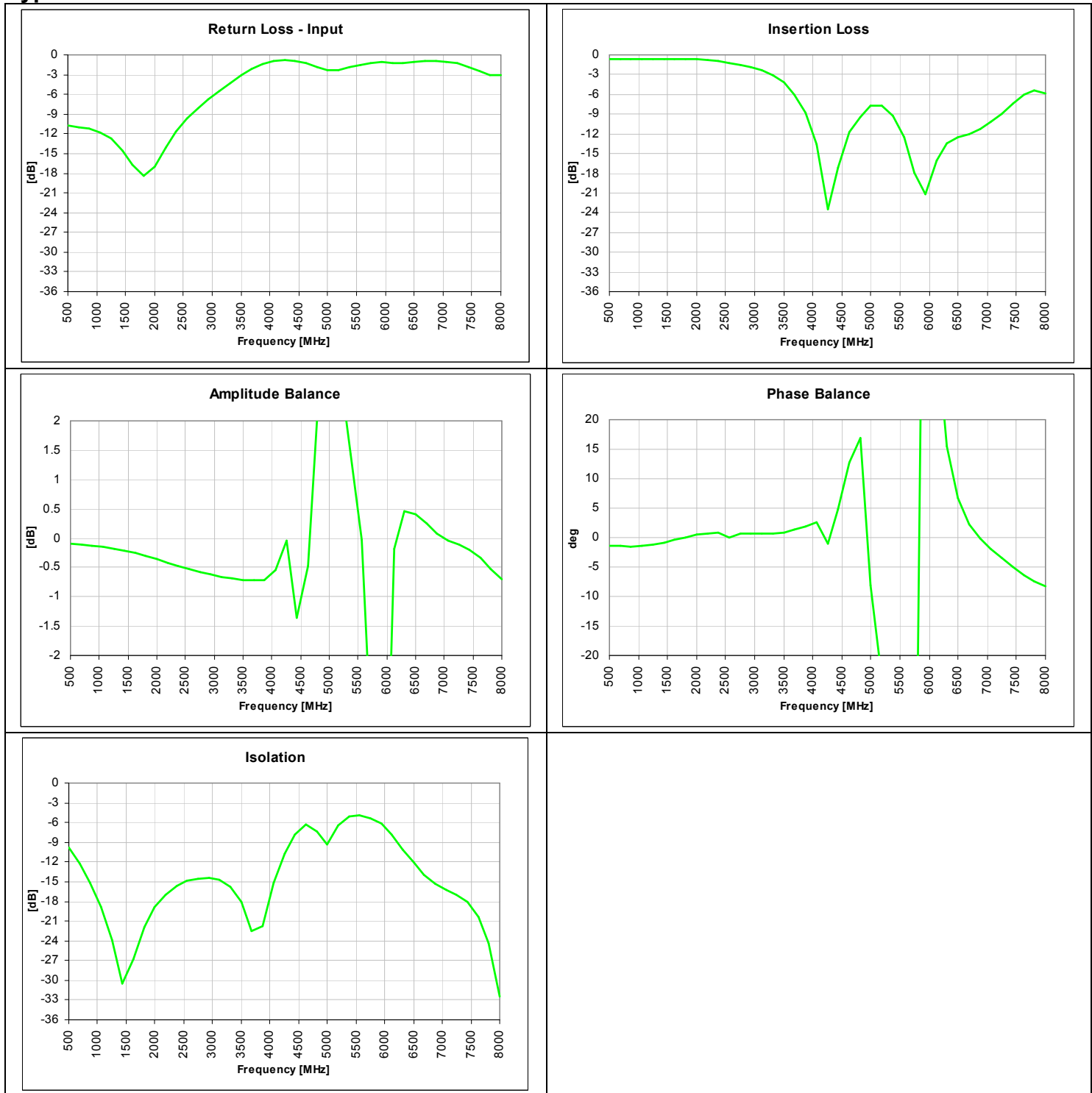

USA/Canada: (315) 432-8909
 Toll Free: (800) 411-6596
 Europe: +44 2392-232392

Available on Tape and Reel for Pick and Place Manufacturing.

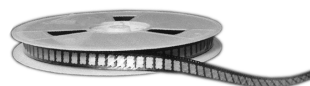

Anaren
 What'll we think of next?™

Typical Performance: 900 MHz. to 2200 MHz.

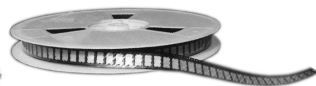
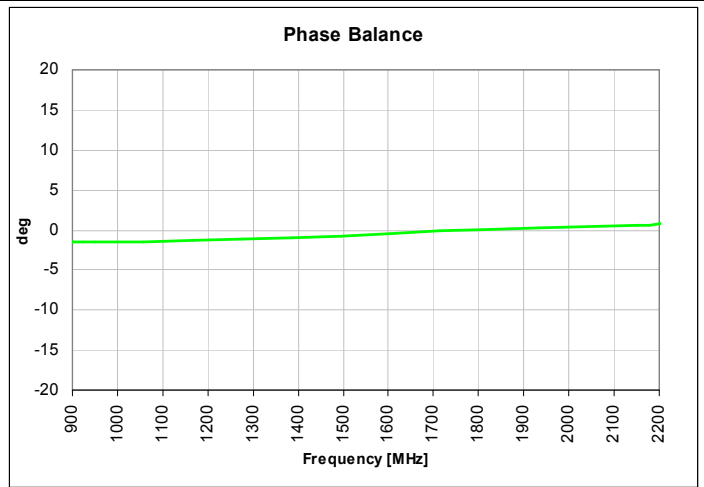
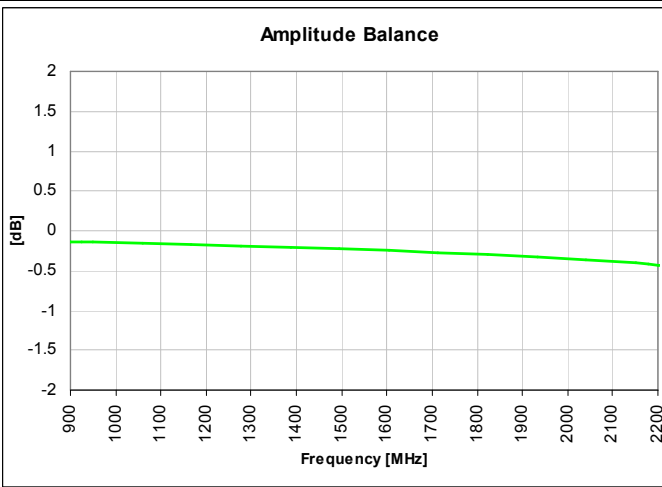
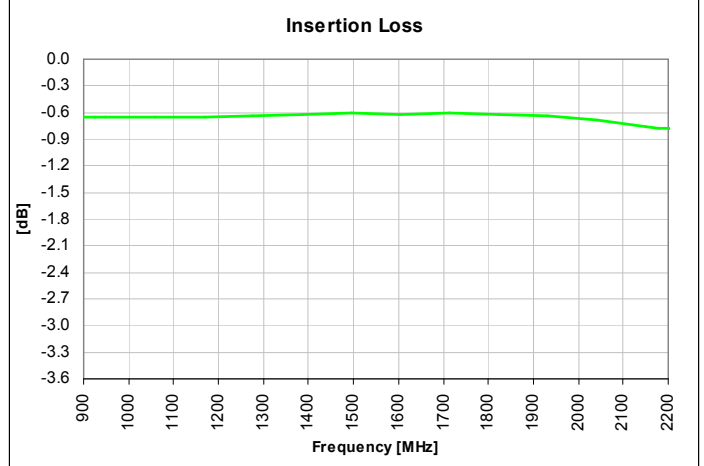
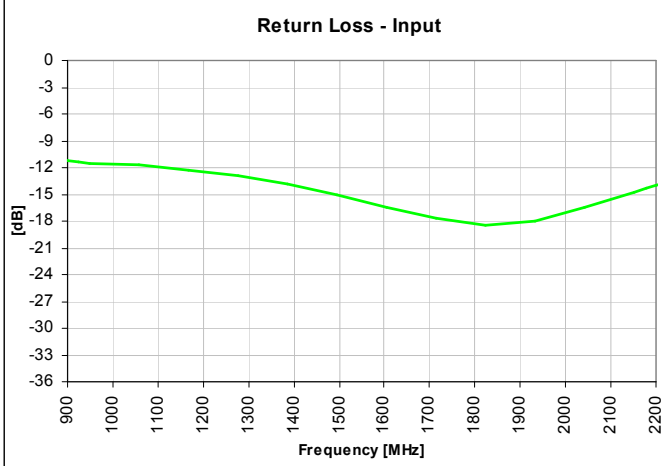

Mounting Configuration:

In order for Xinger surface mount components to work optimally, the proper impedance transmission lines must be used to connect to the RF ports. If this condition is not satisfied, insertion loss, Isolation and VSWR may not meet published specifications.

All of the Xinger components are constructed from ceramic filled PTFE composites which possess excellent electrical and mechanical stability having X and Y thermal coefficient of expansion (CTE) of 17 ppm/°C.

An example of the PCB footprint used in the testing of these parts is shown below. In specific designs, the transmission line widths need to be adjusted to the unique dielectric coefficients and thicknesses as well as varying pick and place equipment tolerances. In addition, since the PD0922J7575D2 is a Wilkinson power divider, external 0402 150Ω and 300Ω resistors must be mounted in locations R1 and R2 respectively, as shown in the Figure below.

Pad Footprint w/ 0402 Resistor Locations

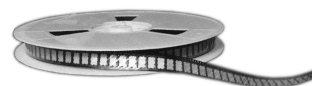
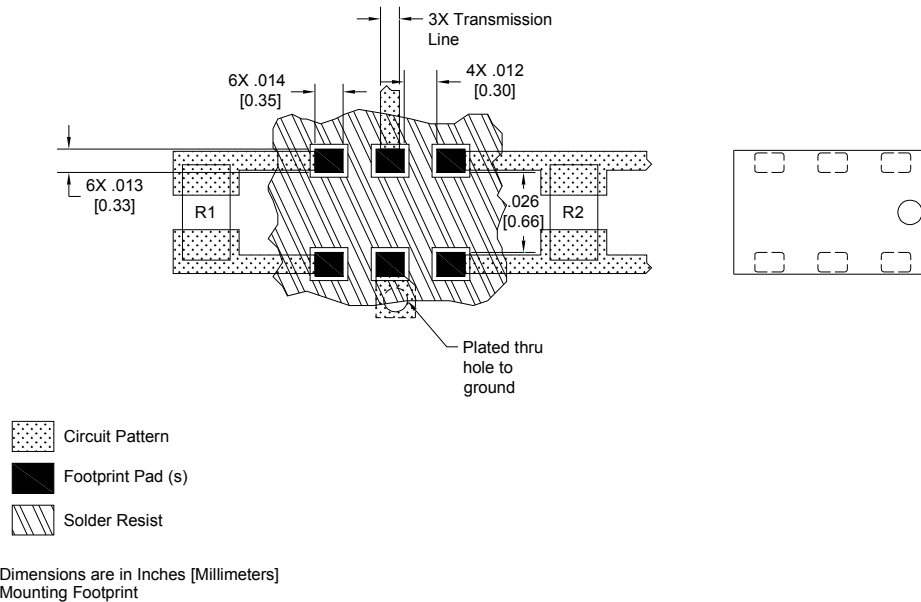

Packaging and Ordering Information

Parts are available in reel and are packaged per EIA 481-2. Parts are oriented in tape and reel as shown below. Minimum order quantities are 4000 per reel. See Model Numbers below for further ordering information.

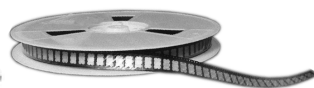
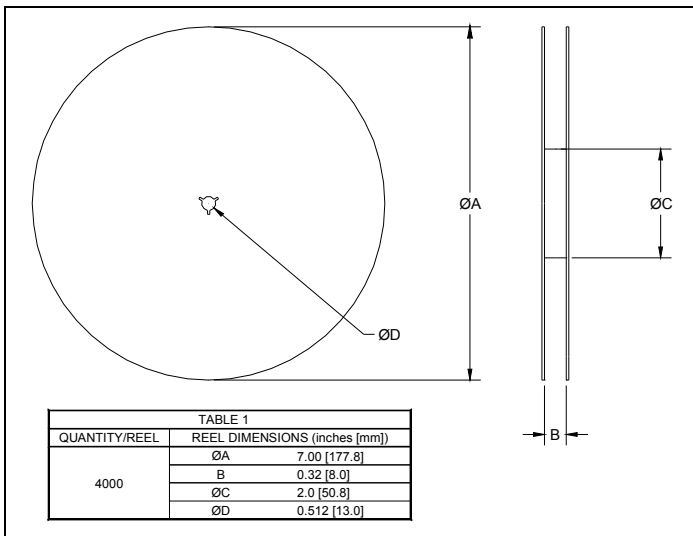
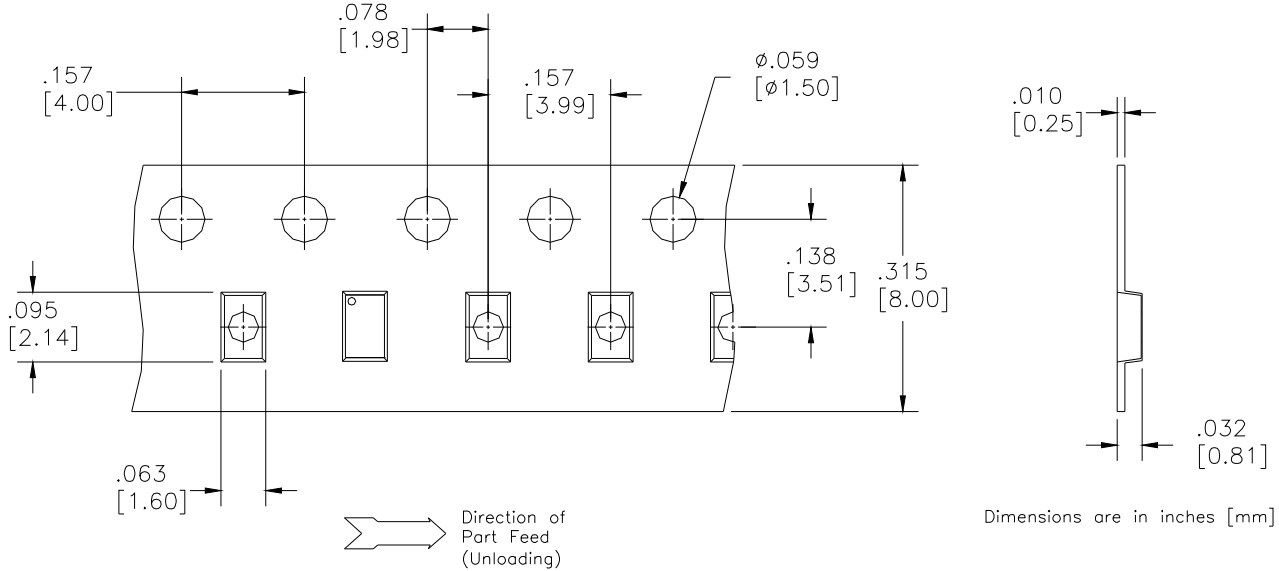

BD 2425 J 50 100 A 00

Function	Frequency	Package Dimensions	Unbalanced Impedance	Balanced Impedance + Coupling	Plating Finish	Codes
B = Balun	0110 = 100 – 1000 MHz	A = 150 x 150 mils	50 = 50 Ohm	25 = 25 Ω Balanced	A = Gold	
BD = Balun + DC	0810 = 800 – 1000 MHz	(4mm x 4mm)	75 = 75 Ohm	30 = 30 Ω Balanced	P = Tin-Lead	
F = Filter	0922 = 950 – 2150 MHz	C = 120 x 120 mils		50 = 50 Ω Balanced		
FB = Filter / Balun	0826 = 800 – 6200 MHz	(3mm x 3mm)		75 = 75 Ω Balanced		
C = 3dB Coupler	1222 = 1200 – 2200 MHz	E = 100 x 80 mils		100 = 100 Ω Balanced		
DC = Directional	1416 = 1400 – 1600 MHz	(2.5mm x 2mm)		150 = 150 Ω Balanced		
J = RF Jumper	1722 = 1700 – 2200 MHz	J = 80 x 50 mils		200 = 200 Ω Balanced		
X = RF cross over	2326 = 2300 – 2600 MHz	(2mm x 1.25mm)		300 = 300 Ω Balanced		
	2425 = 2400 – 2500 MHz	L = 60 x 30 mils		400 = 400 Ω Balanced		
	3150 = 3100 – 5000 MHz	(1.5mm x 0.75mm)		03 = 3dB Hybrid		
	3436 = 3400 – 3600 MHz	N = 40 x 40 mils		10 = 10dB Directional		
	4859 = 4800 – 5900MHz	(1mm x 1mm)		20 = 20dB Directional		
	5153 = 5100 – 5300 MHz					
	5159 = 5100 – 5900 MHz					
	5759 = 5700 – 5900 MHz					

USA/Canada: (315) 432-8909
 Toll Free: (800) 411-6596
 Europe: +44 2392-232392

Available on Tape and Reel for Pick and Place Manufacturing.

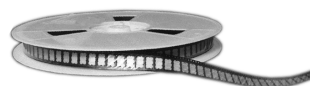

Anaren

What'll we think of next?™

Mouser Electronics

Authorized Distributor

Click to View Pricing, Inventory, Delivery & Lifecycle Information:

[Anaren:](#)

[PD0922J7575D2HF](#)