

MMBTA92-G (PNP) RoHS Device

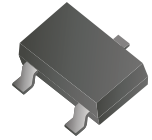

Features

-High voltage transistor.

Diagram:

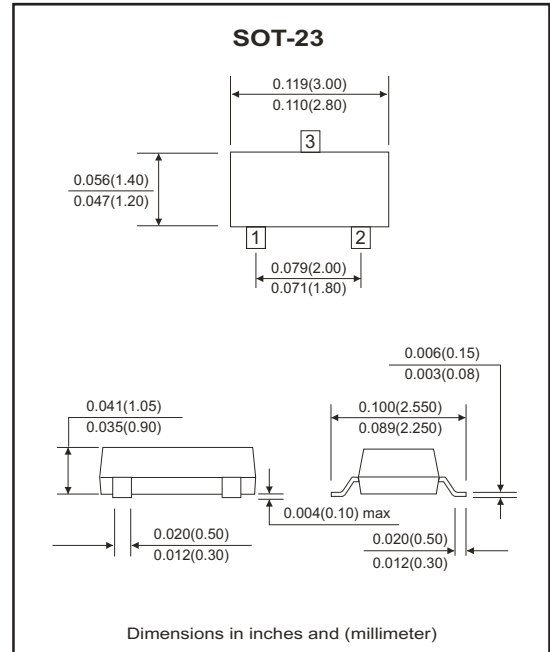
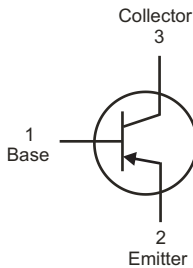

Maximum Ratings (at $T_A=25^{\circ}\text{C}$ unless otherwise noted)

Parameter	Symbol	Value	Unit
Collector-Base voltage	V_{CB0}	-300	V
Collector-Emitter voltage	V_{CEO}	-300	V
Emitter-Base voltage	V_{EBO}	-5	V
Collector current-Continuous	I_C	-200	mA
Collector current-pulsed	I_{CM}	-500	mA
Collector power dissipation	P_C	300	mW
Thermal resistance, junction to ambient	$ROJA$	410	$^{\circ}\text{C/W}$
Junction temperature	T_J	150	$^{\circ}\text{C}$
Storage temperature	T_{STG}	-55 to +150	$^{\circ}\text{C}$

Electrical Characteristics (at $T_A=25^{\circ}\text{C}$, unless otherwise specified)

Parameter	Conditions	Symbol	Min	Max	Unit
Collector-base breakdown voltage	$I_C=-100\mu\text{A}$, $I_E=0$	$V_{(BR)CB0}$	-300		V
Collector-emitter breakdown voltage	$I_C=-1\text{mA}$, $I_B=0$	$V_{(BR)CEO}$	-300		V
Emitter-base breakdown voltage	$I_E=-100\mu\text{A}$, $I_C=0$	$V_{(BR)EBO}$	-5		V
Collector cut-off current	$V_{CB}=-200\text{V}$, $I_E=0$	I_{CBO}		-0.25	μA
Emitter cut-off current	$V_{EB}=-5\text{V}$, $I_C=0$	I_{EBO}		-0.1	μA
DC current gain	$V_{CE}=-10\text{V}$, $I_C=-1\text{mA}$	$h_{FE(1)}$	60		
	$V_{CE}=-10\text{V}$, $I_C=-10\text{mA}$	$h_{FE(2)}$	100	200	
	$V_{CE}=-10\text{V}$, $I_C=-30\text{mA}$	$h_{FE(3)}$	60		
Collector-emitter saturation voltage	$I_C=-20\text{mA}$, $I_B=-2\text{mA}$	$V_{CE(sat)}$		-0.2	V
Base-emitter saturation voltage	$I_C=-20\text{mA}$, $I_B=-2\text{mA}$	$V_{BE(sat)}$		-0.9	V
Transition frequency	$V_{CE}=-20\text{V}$, $I_C=-10\text{mA}$ $f=30\text{MHz}$	f_T	50		MHz

RATING AND CHARACTERISTIC CURVES (MMBTA92-G)

Fig.1- $I_c - V_{CE}$

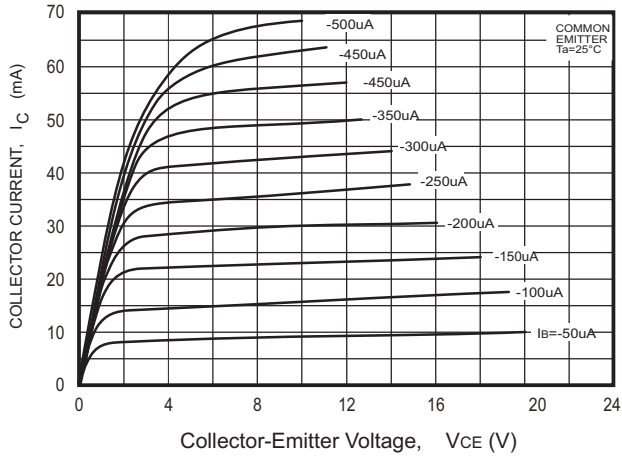

Fig.2- $h_{FE} - I_c$

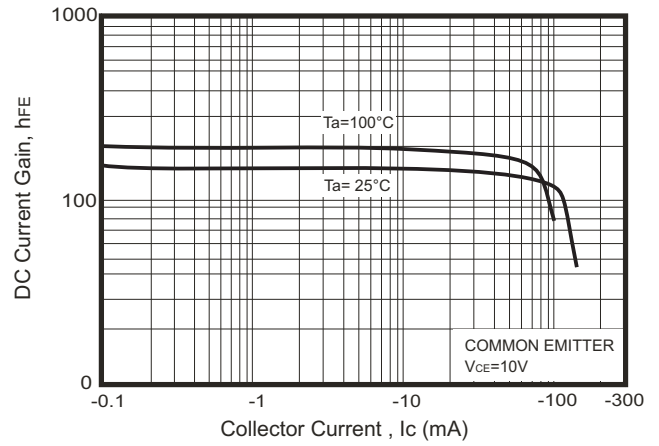

Fig.3 - $V_{CEsat} - I_c$

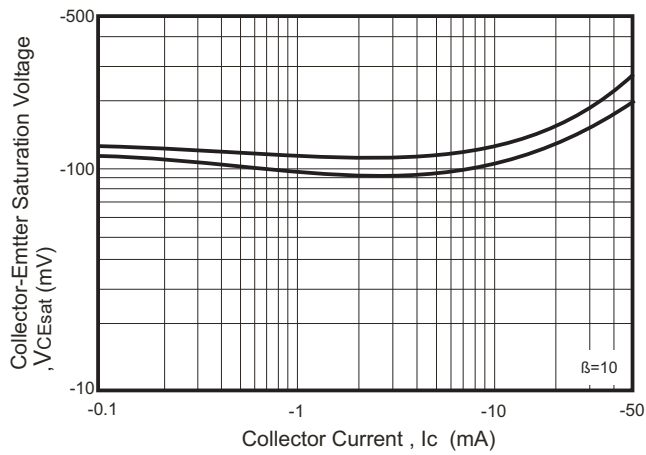

Fig.4 - $V_{BEsat} - I_c$

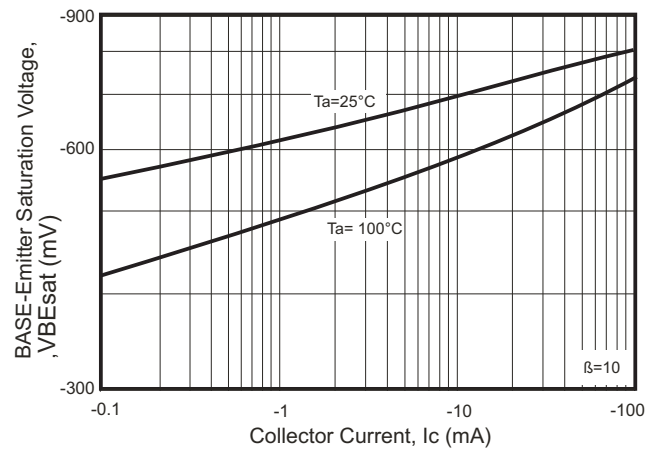

Fig.5 - $I_c - V_{BE}$

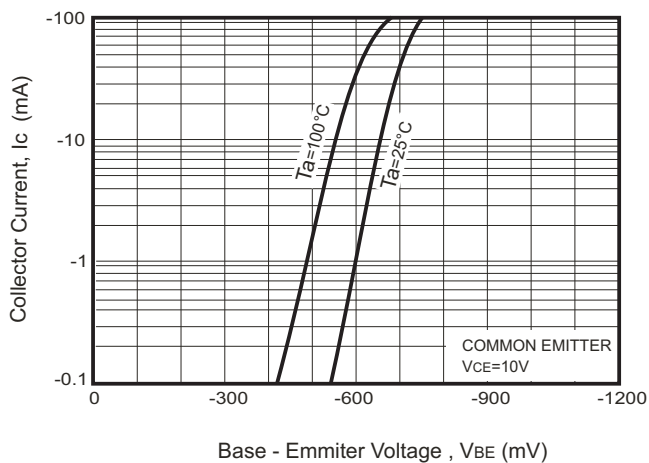
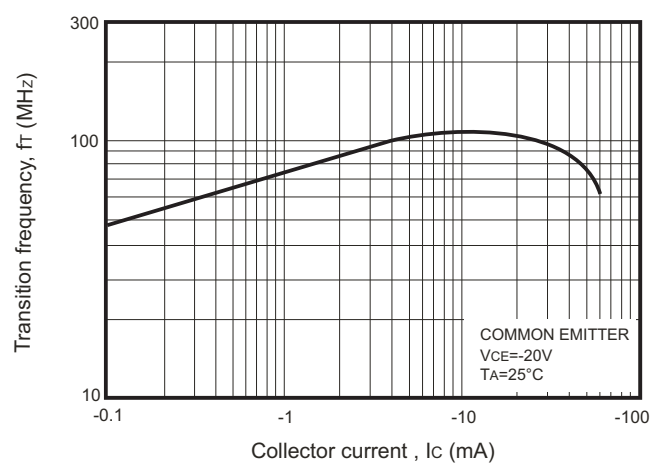

Fig.6 - $f_T - I_c$



RATING AND CHARACTERISTIC CURVES (MMBTA92-G)

Fig. 7- $C_{ob}/C_{ib} - V_{CB}/V_{EB}$

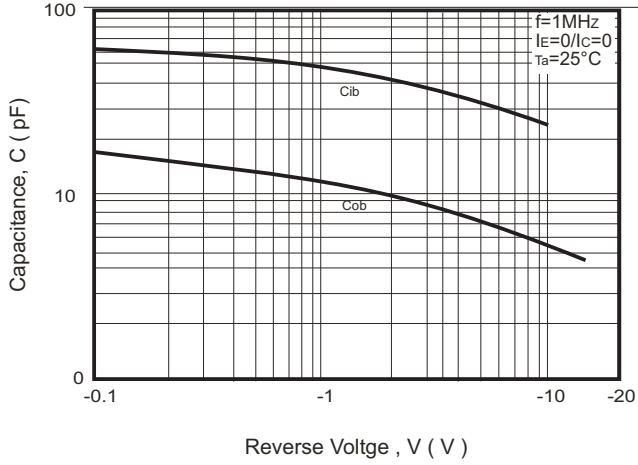
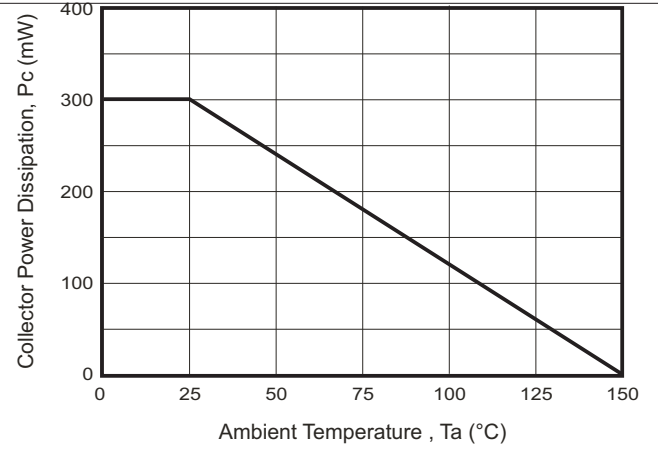
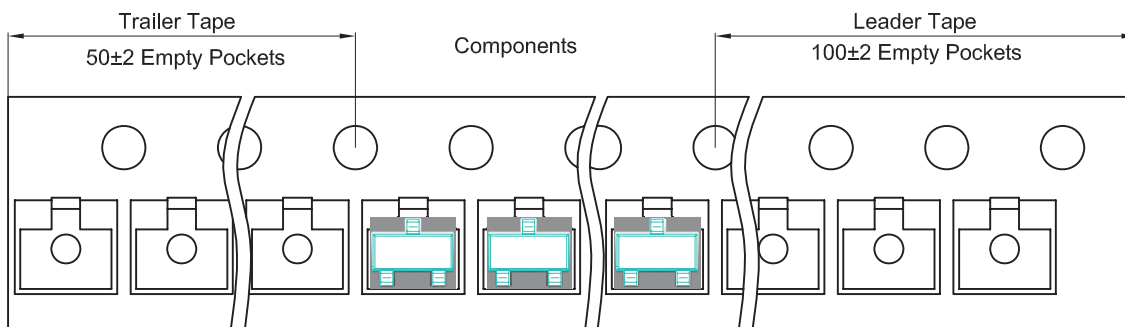
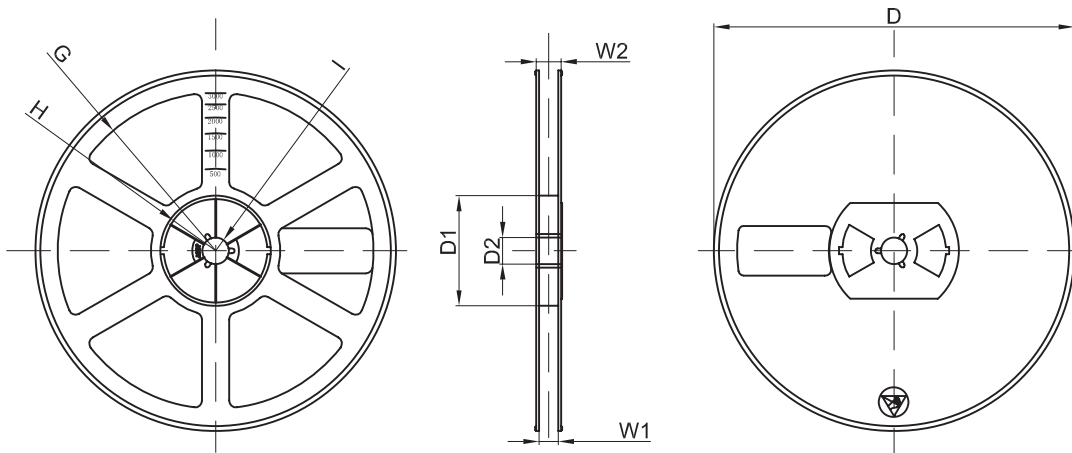
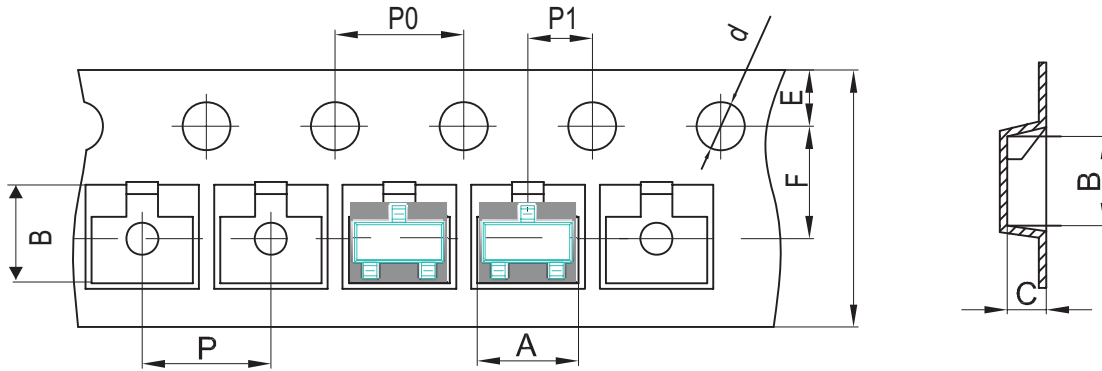

Fig. 8- $P_c - T_a$



Reel Taping Specification



SOT-23	SYMBOL	A	B	C	d	D	D1	D2
	(mm)	3.15 ± 0.10	2.77 ± 0.10	1.22 ± 0.10	1.50 ± 0.10	178 ± 2.00	54.40 ± 1.00	13.00 ± 1.00
	(inch)	0.124 ± 0.004	0.109 ± 0.004	0.048 ± 0.004	0.059 ± 0.004	7.008 ± 0.079	2.142 ± 0.039	0.512 ± 0.039

SOT-23	SYMBOL	E	F	P	P0	P1	W	W1
	(mm)	1.75 ± 0.10	3.50 ± 0.10	4.00 ± 0.10	4.00 ± 0.10	2.00 ± 0.10	8.00 + 0.30 / - 0.10	9.50 ± 1.00
	(inch)	0.069 ± 0.004	0.138 ± 0.004	0.157 ± 0.004	0.157 ± 0.004	0.079 ± 0.004	0.315 + 0.012 / - 0.004	0.374 ± 0.039

Marking Code

Part Number	Marking Code
MMBTA92-G	2D

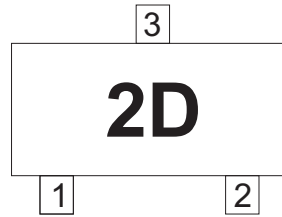

Suggested PAD Layout

SIZE	SOT-23	
	(mm)	(inch)
A	0.80	0.031
B	1.90	0.075
C	2.02	0.080
D	2.82	0.111

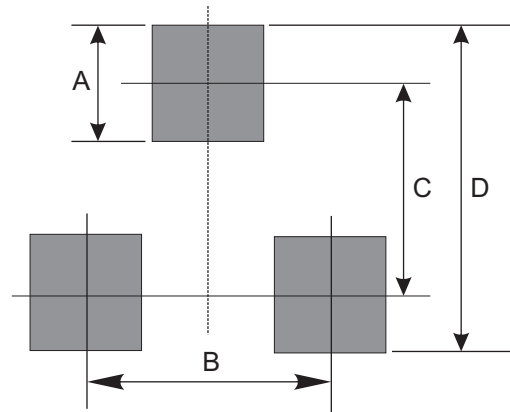

Standard Packaging

Case Type	Qty Per Reel	Reel Size
	(Pcs)	(inch)
SOT-23	3,000	7