

DO - 15

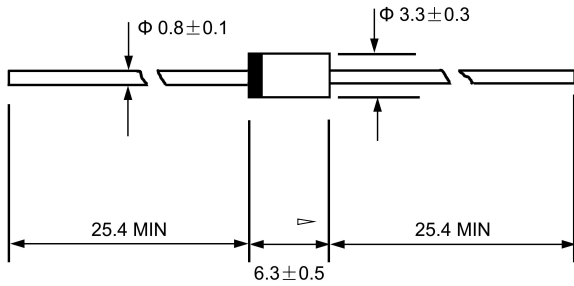

Dimensions in millimeters

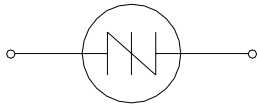

Features

Asidac is a silicon bilateral voltage triggered switch, with greater power-handling capabilities than standard diacs. Upon application of a voltage exceeding the Sidac breakover voltage point, the Sidac switches on, through a negative resistance region, to a low on-state voltage. Conduction will continue until the current is interrupted or drops below the minimum holding current of the device.

Switching voltages in the range of 95 V to 330 V. Sidacs feature glass-passivated junctions that ensure long term reliability and stable characteristics by creating a rugged, reliable barrier against junction contamination.

Variations of devices covered in this data sheet are available for custom design applications. Please consult the factory for more information.

Type	$I_{T(RMS)}$	V_{DRM}	V_{BO}		I_{DRM}	I_{BO}	I_H		V_{TM}	I_{TSM}	R_S		dv/dt	di/dt
	(7) (8)		(1)				(3) (4)			(5)	(9)			
	A	V	V		μA	μA	mA		V	A	k		V/ μ Sec	A/ μ Sec
	MAX	MIN	MIN	MAX	MAX	MAX	TYP	MAX	Max	60Hz	50Hz	MIN	MIN	TYP
K1050G	1	±90	95	113	5	10	60	150	1.5	20	16.7	0.1	1500	150
K1100G	1	±90	104	118	5	10	60	150	1.5	20	16.7	0.1	1500	150
K1200G	1	±90	110	125	5	10	60	150	1.5	20	16.7	0.1	1500	150
K1300G	1	±90	120	138	5	10	60	150	1.5	20	16.7	0.1	1500	150
K1400G	1	±90	130	146	5	10	60	150	1.5	20	16.7	0.1	1500	150
K1500G	1	±90	140	170	5	10	60	150	1.5	20	16.7	0.1	1500	150
K2000G	1	±180	190	215	5	10	60	150	1.5	20	16.7	0.1	1500	150
K2200G	1	±180	205	230	5	10	60	150	1.5	20	16.7	0.1	1500	150
K2400G	1	±190	220	250	5	10	60	150	1.5	20	16.7	0.1	1500	150
K2500G	1	±200	240	280	5	10	60	150	1.5	20	16.7	0.1	1500	150
K2501G	1(10)	±200	240	280	5	75	60	150	6	20	16.7	0.1	1500	150

V-I CHARACTERISTICS

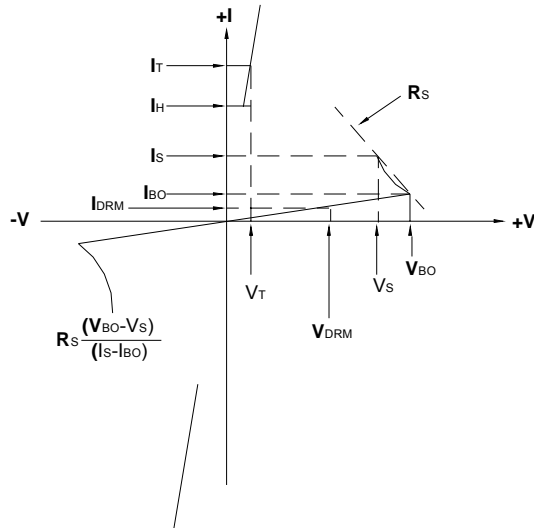
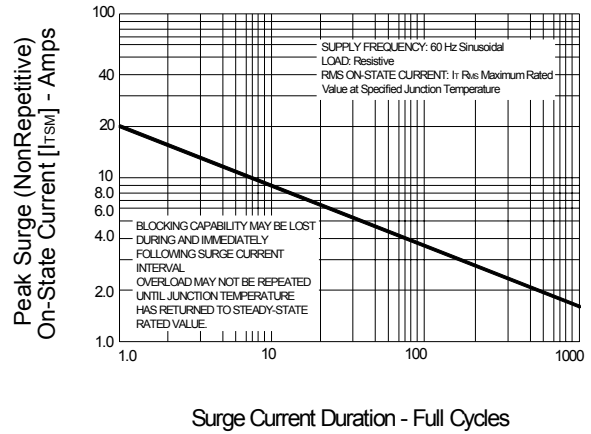

FIG.1-- PEAK SURGE CURRENT vs SURGE CURRENT DURATION



Specific Test Conditions

di/dt — Critical rate-of-rise of on-state current

dv/dt — Critical rate-of-rise of off-state voltage at rated V_{DRM} ; T_J 100°C

I_{BO} — Breakover current 50/60 Hz sine wave

I_{DRM} — Repetitive peak off-state current 50/60 Hz sine wave; $V = V_{DRM}$

I_H — Dynamic holding current 50/60 Hz sine wave; $R = 100$

$I_{T(RMS)}$ — On-state RMS current T_J 125°C 50/60 Hz sine wave

I_{TSM} — Peak one cycle surge current 50/60 Hz sine wave (nonrepetitive)

R_S — Switching resistance $R_S = \frac{(V_{BO} - V_S)}{(I_S - I_{BO})}$ 50/60 Hz sine wave

V_{BO} — Breakover voltage 50/60 Hz sine wave

V_{DRM} — Repetitive peak off-state voltage

V_{TM} — Peak on-state voltage, $I_T = 1$ Amp

General Notes

All measurements are made at 60Hz with a resistive load at an ambient temperature of +25°C unless otherwise specified.

Storage temperature range (T_S) is -65°C to +150°C.

The case (T_C) or lead (T_L) temperature is measured as shown on the dimensional outline drawings. See "Package Dimensions" section of this catalog.

Junction temperature range (T_J) is -40°C to +125°C.

Lead solder temperature is a maximum of +230°C for 10 seconds maximum; 1/16" (1.59mm) from case.

Electrical Specification Notes

(1) See Figure 9.5 for V_{BO} change vs junction temperature.

(2) See Figure 9.6 for I_{BO} vs junction temperature.

(3) See Figure 9.2 for I_H vs case temperature.

(4) See Figure 9.13 for test circuit.

(5) See Figure 9.1 for more than one full cycle rating.

(6) $R_{\theta JA}$ Type 41 is 70° C/W.

(7) T_L 100°C

(8) See Figure 9.14 for clarification of Sidac operation.

(9) For best Sidac operation, the load impedance should be near or less than switching resistance.

FIG.2 – NORMALIZED DC HOLDING CURRENT vs CASE/LEAD TEMPERATURE

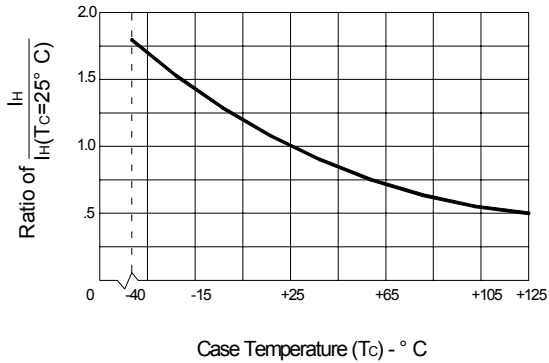

FIG.3- REPETITIVE PEAK ON-STATE CURRENT (I_{TRM}) vs PULSE WIDTH at VARIOUS FREQUENCIES

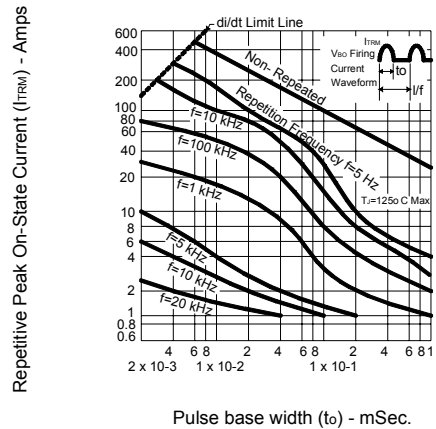

FIG.4 – MAXIMUM ALLOWABLE AMBIENT TEMPERATURE vs ON-STATE CURRENT

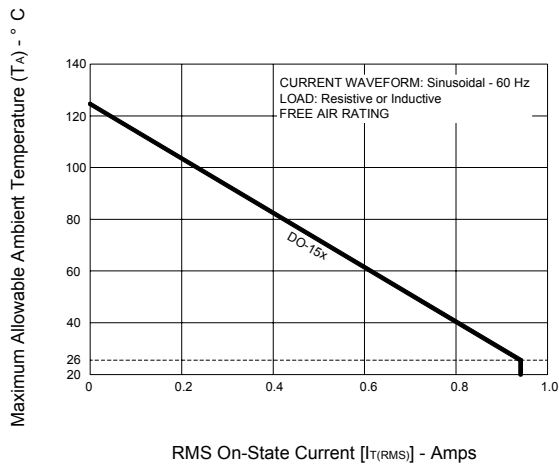

FIG.5 – NORMALIZED V_{BO} CHANGE vs JUNCTION TEMPERATURE

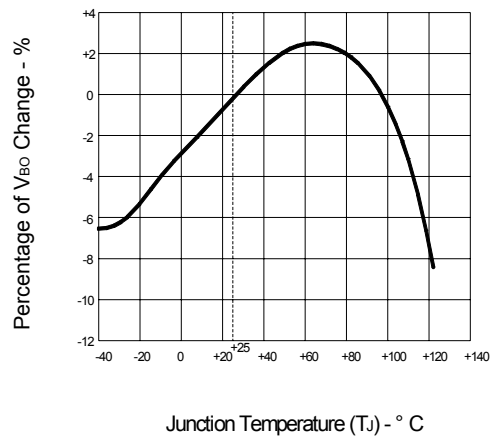

FIG.6 – NORMALIZED REPETITIVE PEAK BREAKOVER CURRENT vs JUNCTION TEMPERATURE

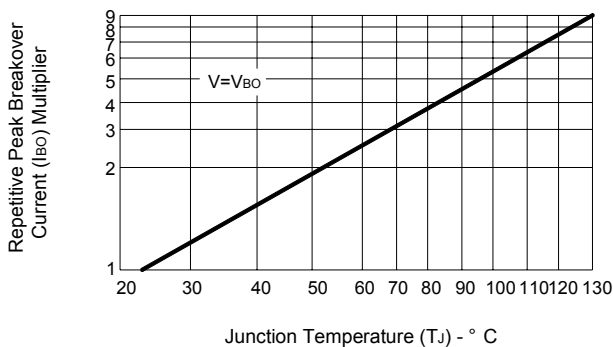

FIG.7 – ON-STATE CURRENT vs ON-STATE VOLTAGE (TYPICAL)

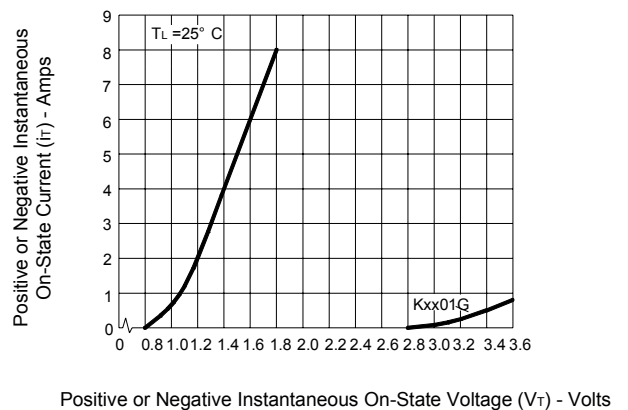

FIG.8 – POWER DISSIPATION (TYPICAL) vs ON-STATE CURRENT

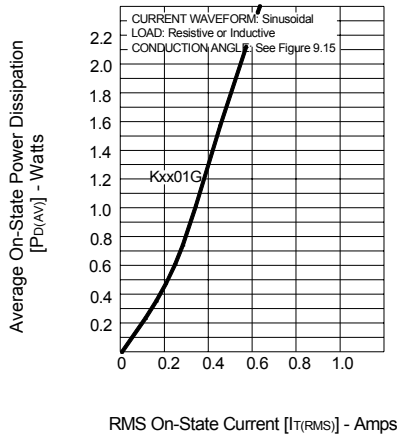

FIG.9 – COMPARISON OF SIDAC vs SCR

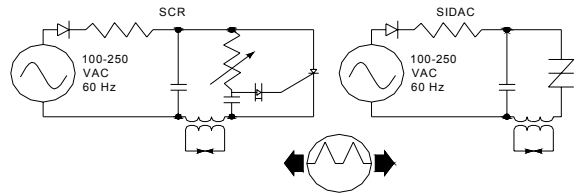

FIG.10 – LGNITOR CIRCUIT (LOW VOLTAGE INPUT)

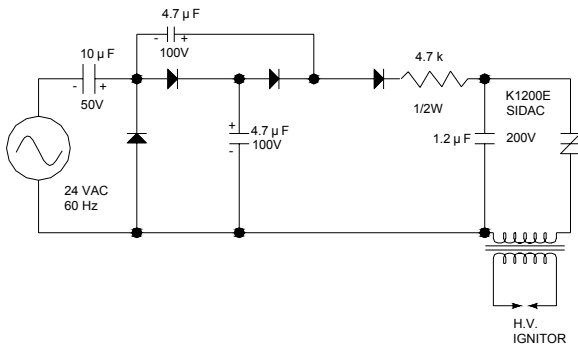

FIG.11 – TYPICAL HIGH PRESSURE SODIUM LAMP FIRING CIRCUIT

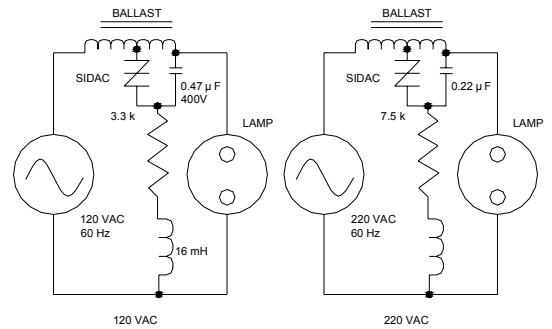

FIG.12 – XENON LAMP FLASHING CIRCUIT

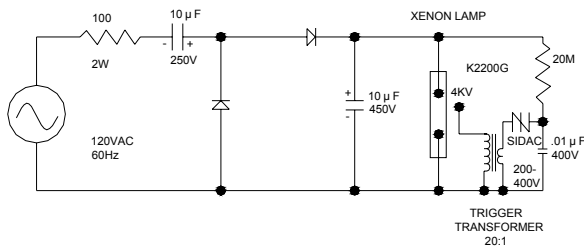

FIG.13 – DYNAMIC HOLDING CURRENT TEST CIRCUIT FOR SIDACS

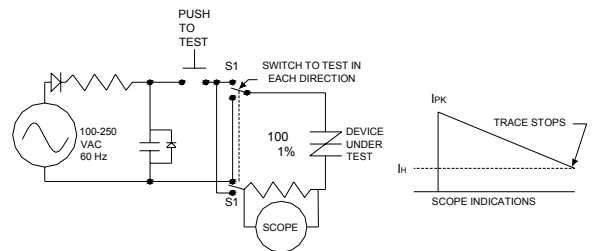

FIG.14 – BASIC SIDAC CIRCUIT

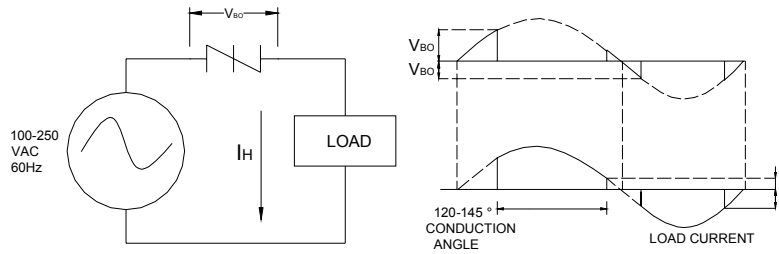

FIG.15 – RELAXATION OSCILLATOR USING a SIDAC

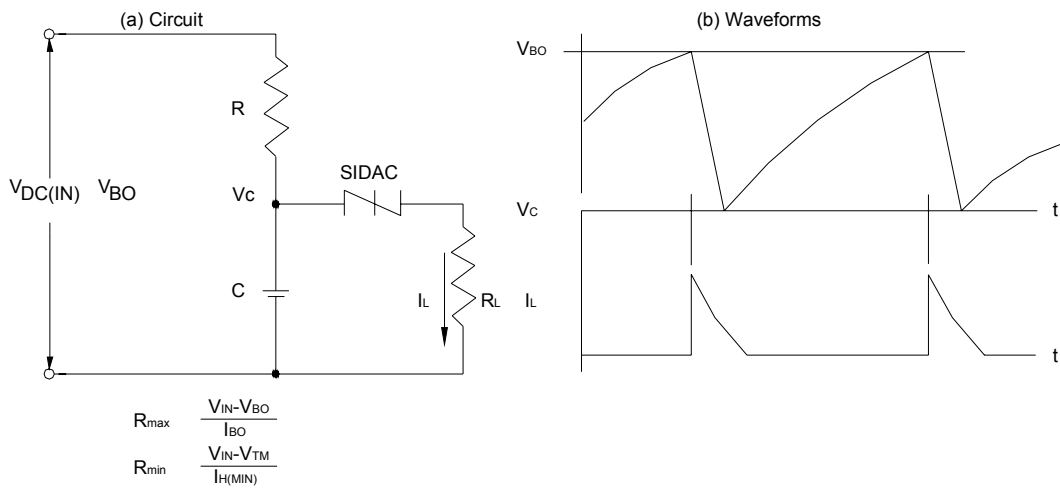
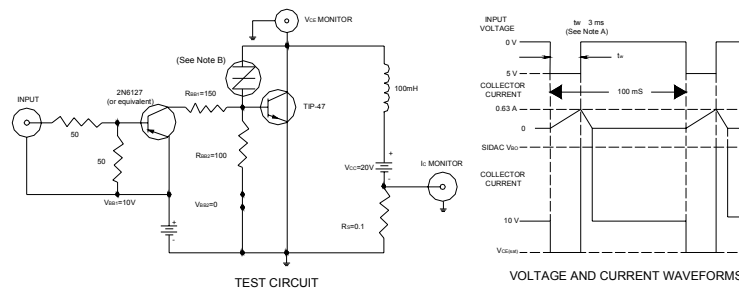

FIG.16 – SIDAC ADDED TO PROTECT TRANSISTOR FOR TYPICAL TRANSISTOR INDUCTIVE LOAD SWITCHING REQUIREMENTS



NOTE A: Input pulse width is increased until $I_{CM} = 0.63A$.

NOTE B: Sidac (or Diac or series of Diacs) chosen so that V_{BO} is just below V_{CEO} rating of transistor to be protected. The Sidac (or Diac) eliminates a reverse breakdown of the transistor in inductive switching circuits where otherwise the transistor could be destroyed.