

Features

- Floating channel designed for bootstrap operation
- Fully operational to +600 V
- Tolerant to negative transient voltage – dV/dt immune
- Gate drive supply range from 10 V to 20 V
- Undervoltage lockout for both channels
- 3.3 V input logic compatible
- Separate logic supply range from 3.3 V to 20 V
- Logic and power ground ± 5 V offset
- CMOS Schmitt-triggered inputs with pull-down
- Cycle by cycle edge-triggered shutdown logic
- Matched propagation delay for both channels
- Output in phase with inputs
- Leadfree, RoHS Compliant

Description

The IRS2113MPBF is a high voltage, high speed power MOSFET and IGBT drivers with independent high and low side referenced output channels. Proprietary HVIC and latch immune CMOS technologies enable ruggedized monolithic construction. The logic input is compatible with standard CMOS or LSTTL output, down to 3.3 V logic. The output drivers feature a high pulse current buffer stage designed for minimum driver cross-conduction. Propagation delays are matched to simplify use in high frequency applications. The floating channel can be used to drive an N-channel power MOSFET or IGBT in the high side configuration which operates up to 600 V.

Product Summary

Topology	2 channels
V_{OFFSET}	600 V max
V_{OUT}	10 V – 20 V
$I_{\text{o+}}$ & $I_{\text{o-}}$ (typical)	2.5 A / 2.5 A
t_{ON} & t_{OFF} (typical)	130 ns & 120 ns
Delay Matching	20 ns max

Package Option



MLPQ4x4-16-Lead
(without 2 leads)

Typical Connection Diagram

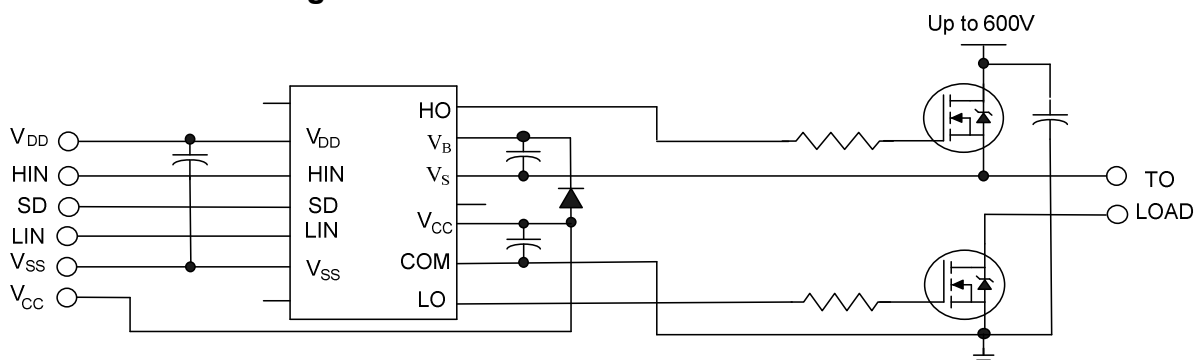

(Refer to Leads Assignment for correct pin configurations) This diagram shows electrical connections only. Please refer to our Application Notes and Design Tips for proper circuit board layout.

Qualification Information[†]

Qualification Level		Industrial ^{††} (per JEDEC JESD 47)	
		Comments: This IC has passed JEDEC's Industrial qualification. IR's Consumer qualification level is granted by extension of the higher Industrial level.	
Moisture Sensitivity Level		MLPQ4x4 14L	MSL2 ^{†††} (per IPC/JEDEC J-STD-020)
ESD	Machine Model	Class A (+/-200V) (per JEDEC standard JESD22-A115)	
	Human Body Model	Class 1B (+/-1000V) (per EIA/JEDEC standard EIA/JESD22-A114)	
	Charged Device Model	Class III (+/-1000V) (per JEDEC standard JESD22-C101)	
IC Latch-Up Test		Class II, Level A (per JESD78A)	
RoHS Compliant		Yes	

† Qualification standards can be found at International Rectifier's web site <http://www.irf.com/>

†† Higher qualification ratings may be available should the user have such requirements. Please contact your International Rectifier sales representative for further information.

††† Higher MSL ratings may be available for the specific package types listed here. Please contact your International Rectifier sales representative for further information.

Absolute Maximum Ratings

Absolute Maximum Ratings indicate sustained limits beyond which damage to the device may occur. All voltage parameters are absolute voltages referenced to COM. The thermal resistance and power dissipation ratings are measured under board mounted and still air conditions.

Symbol	Definition	Min.	Max.	Units
V_B	High-side floating supply voltage	-0.3	625	V
V_S	High-side floating supply offset voltage	$V_B - 20$	$V_B + 0.3$	
V_{HO}	High-side floating output voltage	$V_S - 0.3$	$V_B + 0.3$	
V_{CC}	Low-side fixed supply voltage	-0.3	25	
V_{LO}	Low-side output voltage	-0.3	$V_{CC} + 0.3$	
V_{DD}	Logic supply voltage	-0.3	$V_{SS} + 20$ (†)	
V_{SS}	Logic supply offset voltage	$V_{CC} - 20$	$V_{CC} + 0.3$	
V_{IN}	Logic input voltage (HIN, LIN & SD)	$V_{SS} - 0.3$	$V_{DD} + 0.3$	
dV_S/dt	Allowable offset supply voltage transient (Fig. 2)	—	50	V/ns
P_D	Package power dissipation @ $T_A \leq 25^\circ\text{C}$	—	2.08	W
R_{thJA}	Thermal resistance, junction to ambient	—	36	$^\circ\text{C}/\text{W}$
T_J	Junction temperature	—	150	$^\circ\text{C}$
T_S	Storage temperature	-55	150	
T_L	Lead temperature (soldering, 10 seconds)	—	300	

† All supplies are fully tested at 25 V, and an internal 20 V clamp exists for each supply.

Recommended Operating Conditions

The input/output logic timing diagram is shown in Figure 1. For proper operation the device should be used within the recommended conditions. The V_S and V_{SS} offset rating are tested with all supplies biased at 15 V differential.

Symbol	Definition	Min.	Max.	Units
V_B	High-side floating supply absolute voltage	$V_S + 10$	$V_S + 20$	V
V_S	High-side floating supply offset voltage	†	600	
V_{HO}	High-side floating output voltage	V_S	V_B	
V_{CC}	Low-side fixed supply voltage	10	20	
V_{LO}	Low-side output voltage	0	V_{CC}	
V_{DD}	Logic supply voltage	$V_{SS} + 3$	$V_{SS} + 20$	
V_{SS}	Logic ground offset voltage	-5 (††)	5	
V_{IN}	Logic input voltage (HIN, LIN & SD)	V_{SS}	V_{DD}	
T_A	Ambient temperature	-40	125	$^\circ\text{C}$

† Logic operational for V_S of -4 V to +500 V. Logic state held for V_S of -4 V to $-V_{BS}$.
(Please refer to the Design Tip DT97 -3 for more details).

†† When $V_{DD} < 5$ V, the minimum V_{SS} offset is limited to $-V_{DD}$.

Static Electrical Characteristics

V_{BIAS} (V_{CC} , V_{BS} , V_{DD}) = 15 V, T_A = 25°C and V_{SS} = COM unless otherwise specified. The V_{IL} , V_{TH} and I_{IN} parameters are referenced to V_{SS} and are applicable to all three logic input leads: HIN, LIN and SD. The V_O and I_O parameters are referenced to COM and are applicable to the respective output leads: HO or LO.

Symbol	Definition	Min	Typ	Max	Units	Test Conditions	
V_{IH}	Logic "1" input voltage	9.5	—	—	V		
V_{IL}	Logic "0" input voltage	—	—	6.0			
V_{OH}	High level output voltage, $V_{BIAS} - V_O$	—	—	1.4			$I_O = 0$ A
V_{OL}	Low level output voltage, V_O	—	—	0.15			$I_O = 20$ mA
I_{LK}	Offset supply leakage current	—	—	50	μ A	$V_B = V_S = 600$ V	
I_{QBS}	Quiescent V_{BS} supply current	—	125	230		$V_{IN} = 0$ V or V_{DD}	
I_{QCC}	Quiescent V_{CC} supply current	—	180	340			
I_{QDD}	Quiescent V_{DD} supply current	—	15	30			
I_{IN+}	Logic "1" input bias current	—	20	40		$V_{IN} = V_{DD}$	
I_{IN-}	Logic "0" input bias current	—	—	5.0		$V_{IN} = 0$ V	
V_{BSUV+}	V_{BS} supply undervoltage positive going threshold	7.5	8.6	9.7	V		
V_{BSUV-}	V_{BS} supply undervoltage negative going threshold	7.0	8.2	9.4			
V_{CCUV+}	V_{CC} supply undervoltage positive going threshold	7.4	8.5	9.6			
V_{CCUV-}	V_{CC} supply undervoltage negative going threshold	7.0	8.2	9.4			
I_{O+}	Output high short circuit pulsed current	2.0	2.5	—	A	$V_O = 0$ V, $V_{IN} = V_{DD}$ $PW \leq 10$ μ s	
I_{O-}	Output low short circuit pulsed current	2.0	2.5	—		$V_O = 15$ V, $V_{IN} = 0$ V $PW \leq 10$ μ s	

Dynamic Electrical Characteristics

V_{BIAS} (V_{CC} , V_{BS} , V_{DD}) = 15 V, C_L = 1000 pF, T_A = 25°C and V_{SS} = COM unless otherwise specified. The dynamic electrical characteristics are measured using the test circuit shown in Fig. 3.

Symbol	Definition	Min	Typ	Max	Units	Test Conditions
t_{on}	Turn-on propagation delay	—	130	200	ns	$V_S = 0$ V
t_{off}	Turn-off propagation delay	—	120	190		$V_S = 600$ V
t_{sd}	Shutdown propagation delay	—	130	160		
t_r	Turn-on rise time	—	25	35		
t_f	Turn-off fall time	—	17	25		
MT	Delay matching, HS & LS turn on/off	—	—	20		

Functional Block Diagram

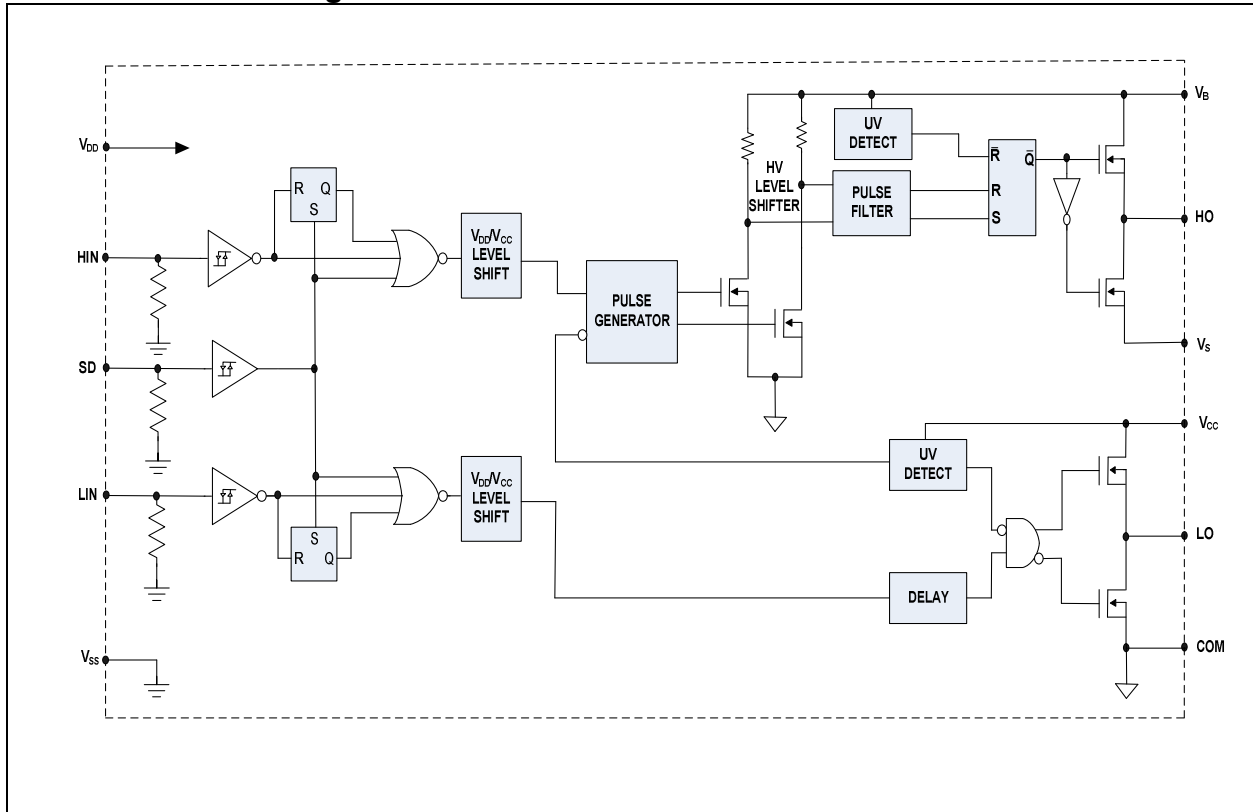

Input/Output Pin Equivalent Circuit Diagrams

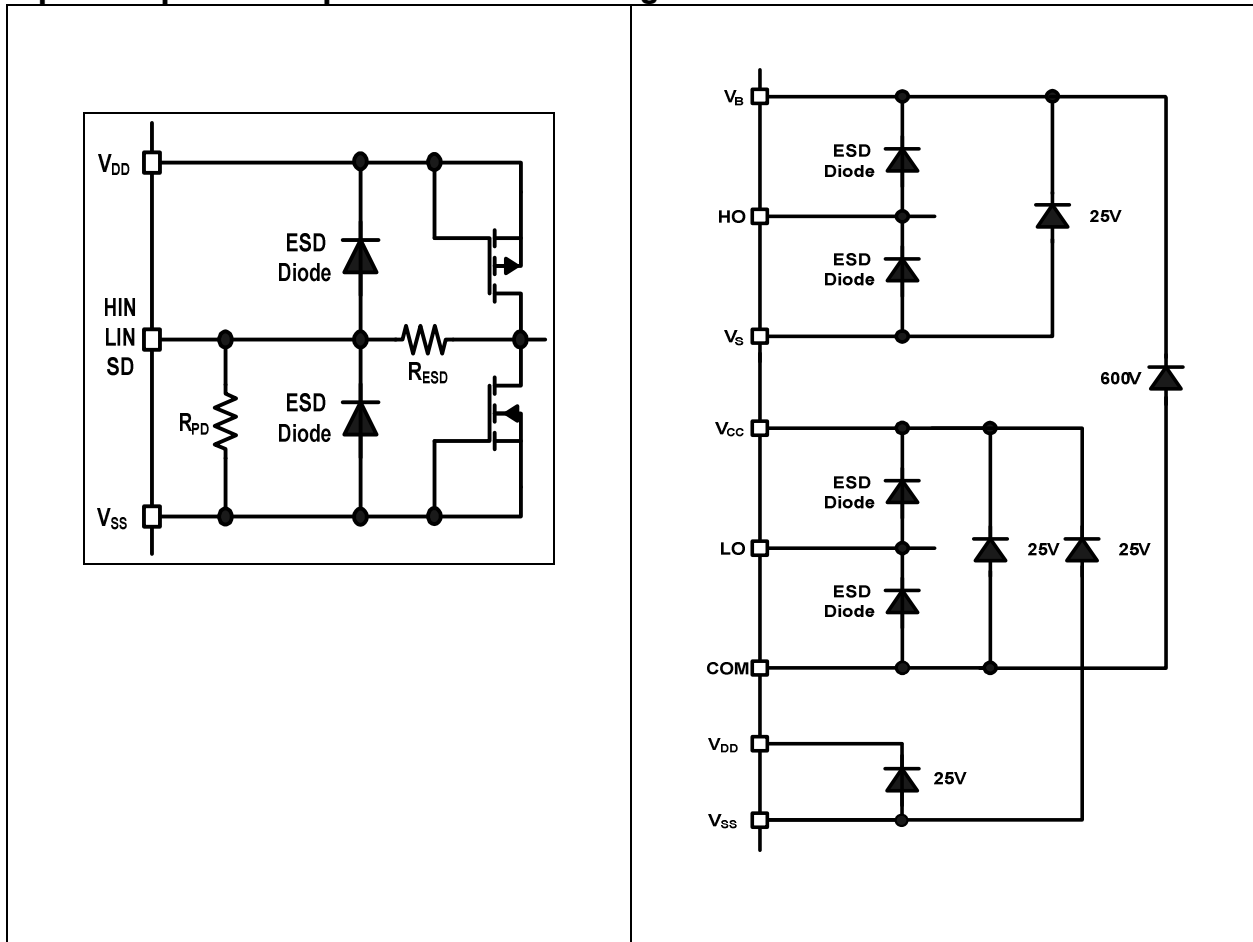

Lead Definitions

PIN	Symbol	Description
1	V _{DD}	Logic supply
2	HIN	Logic input for high-side gate driver output (HO), in phase
3	SD	Logic input for shutdown
4	LIN	Logic input for low-side gate driver output (LO), in phase
5	V _{SS}	Logic ground
6	LO	Low-side gate drive output
7	COM	Low-side return
8	NC	No Connection
9	V _{CC}	Low-side supply
10	NC	No Connection (pin removed)
11	NC	No Connection
12	V _S	High-side floating supply return
13	V _B	High-side floating supply
14	HO	High-side gate drive output
15	NC	No Connection (pin removed)
16	NC	No Connection

Lead Assignments

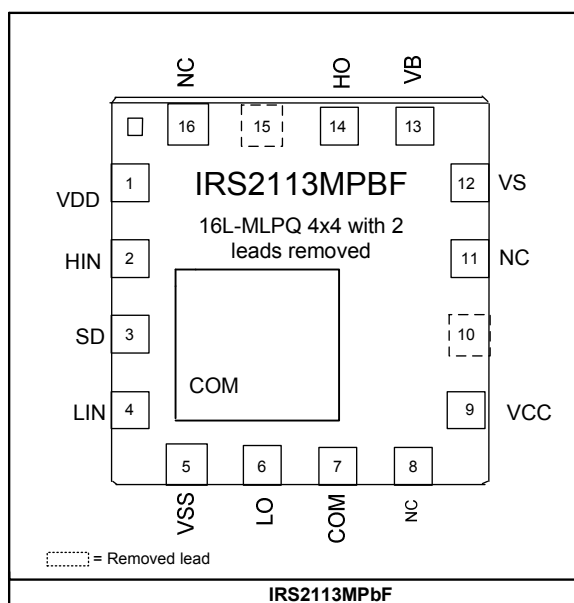

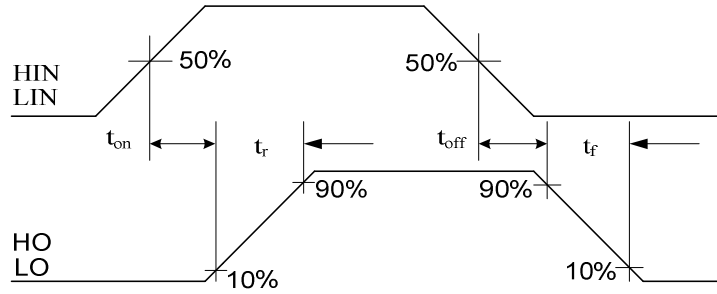

Figure 4: Switching Time Waveform Definitions

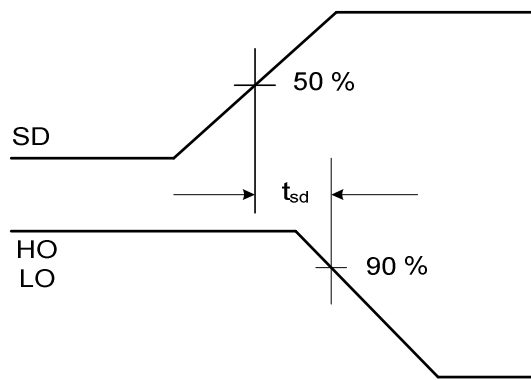

Figure 5: Shutdown Waveform Definitions

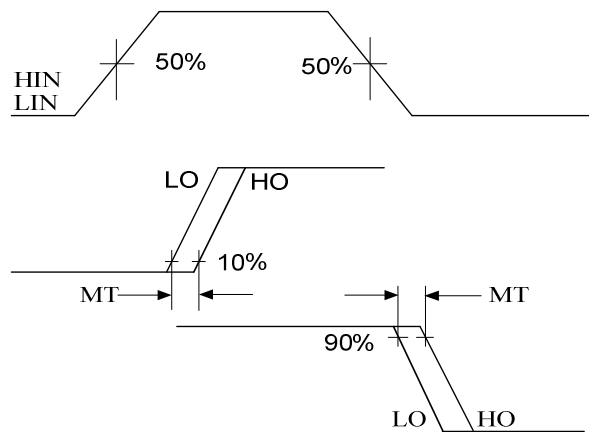

Figure 6: Delay Matching Waveform Definitions

Parameter Temperature Trends

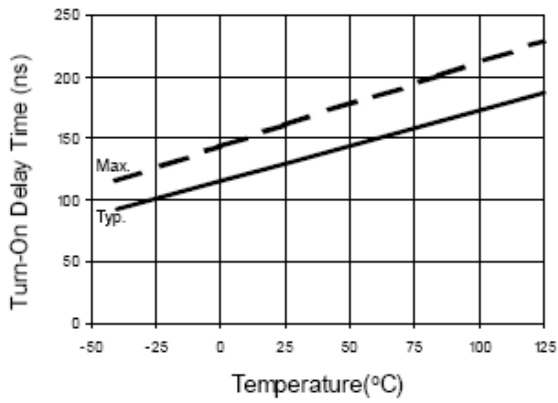

Figure 7A. Turn-On Time vs. Temperature

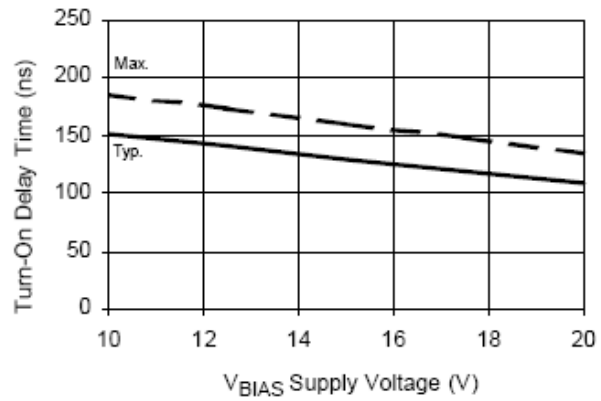

Figure 7B. Turn-On Time vs. Supply Voltage

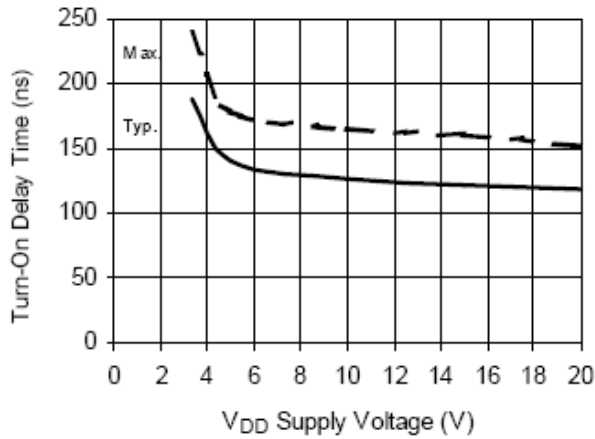

Figure 7C. Turn-On Time vs. V_{DD} Supply Voltage

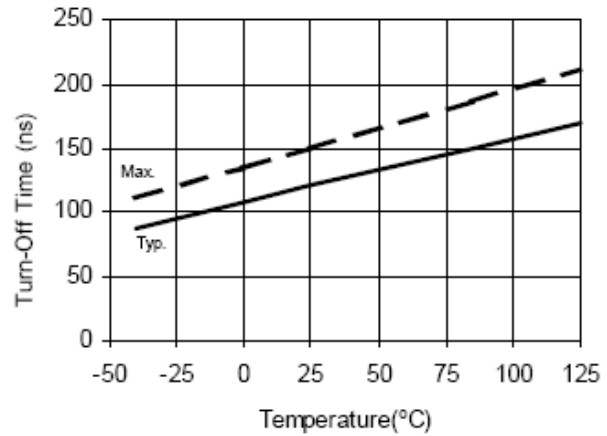

Figure 8A. Turn-Off Time vs. Temperature

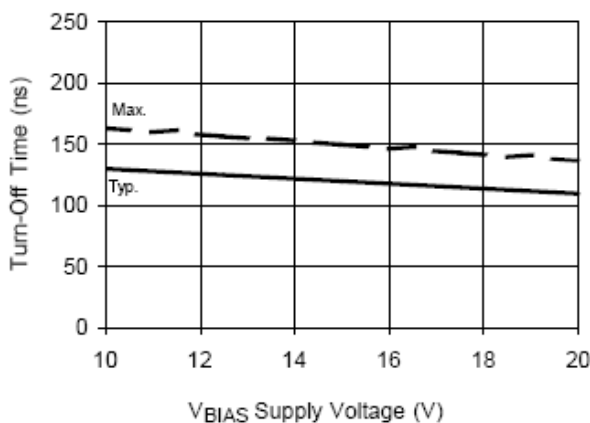

Figure 8B. Turn-Off Time vs. Supply Voltage

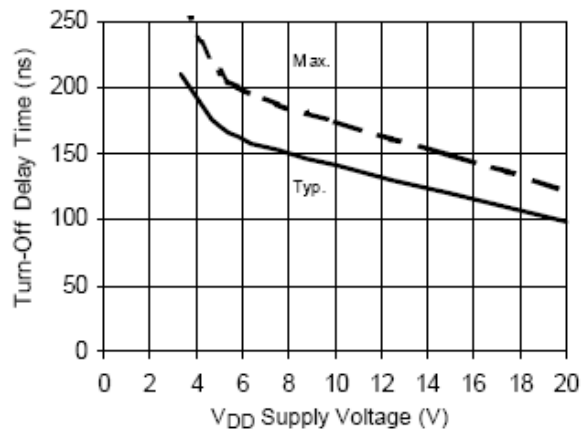

Figure 8C. Turn-Off Time vs. V_{DD} Supply Voltage

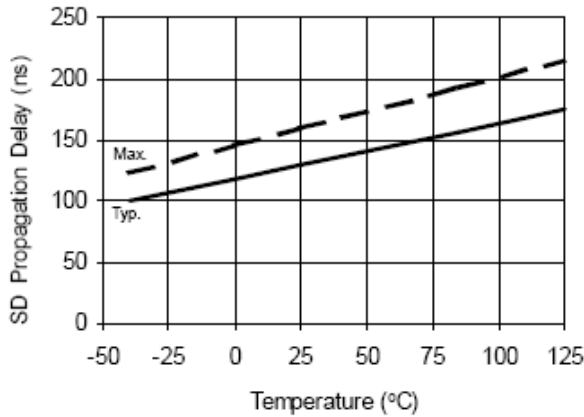

Figure 9A. Shutdown Time vs. Temperature

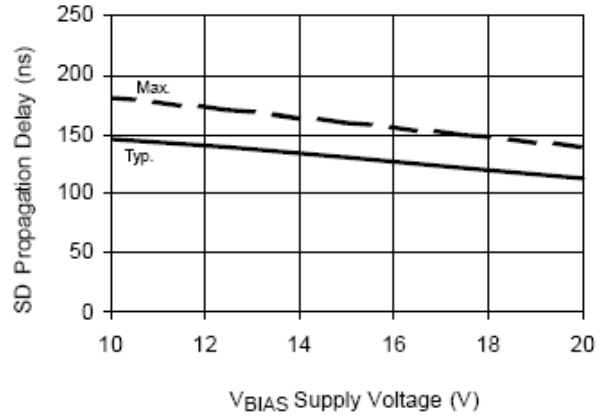

Figure 9B. Shutdown Time vs. Supply Voltage

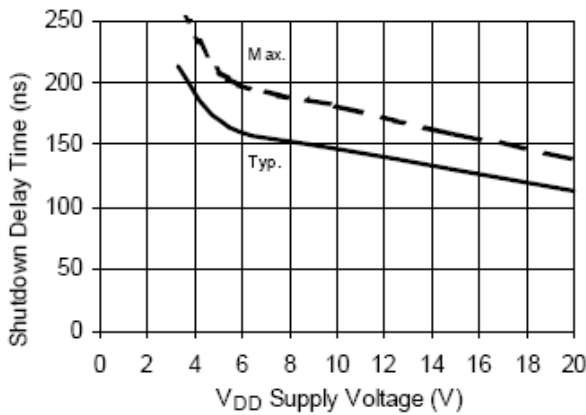

Figure 9C. Shutdown Time vs. VDD Supply Voltage

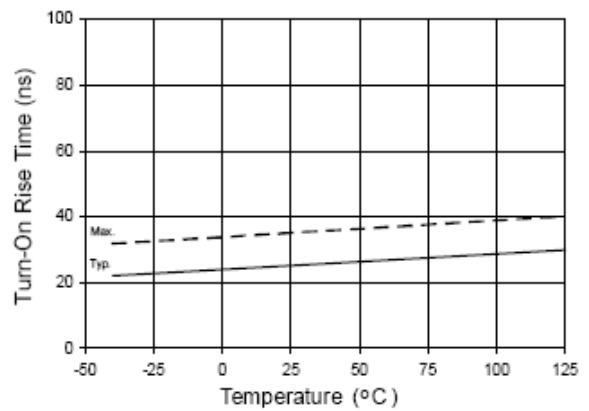

Figure 10A. Turn-On Rise Time vs. Temperature

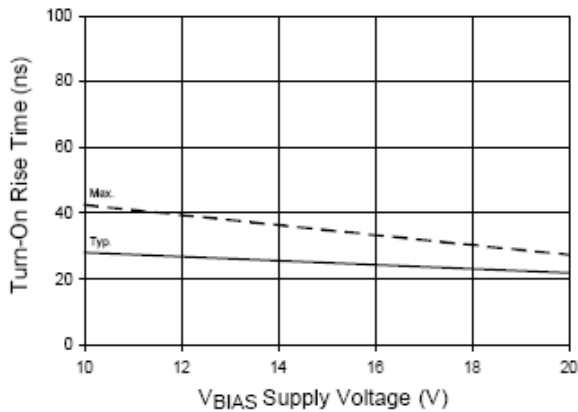

Figure 10B. Turn-On Rise Time vs. Voltage

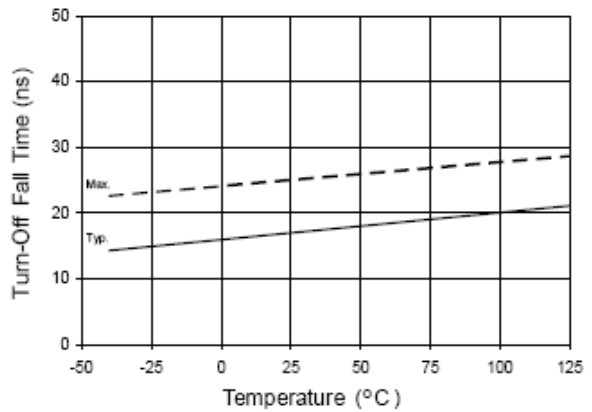

Figure 11A. Turn-Off Fall Time vs. Temperature

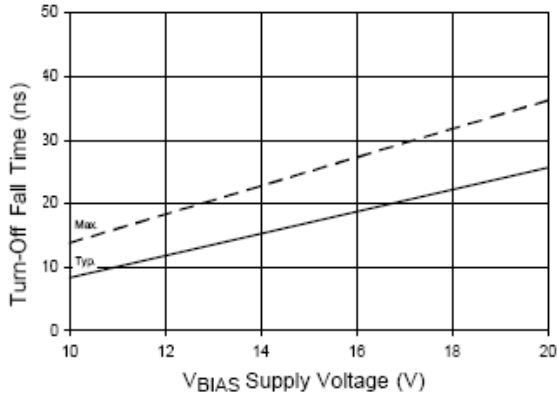

Figure 11B. Turn-Off Fall Time vs. Voltage

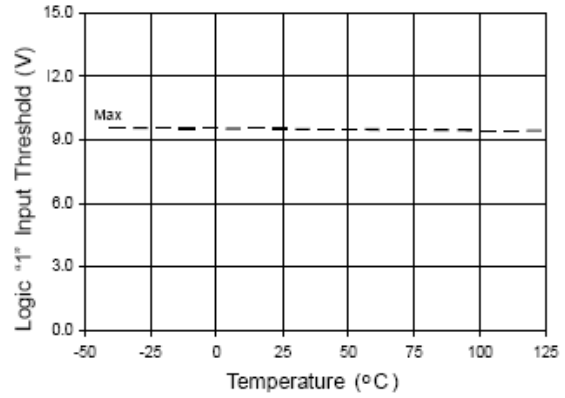

Figure 12A. Logic "1" Input Threshold vs. Temperature

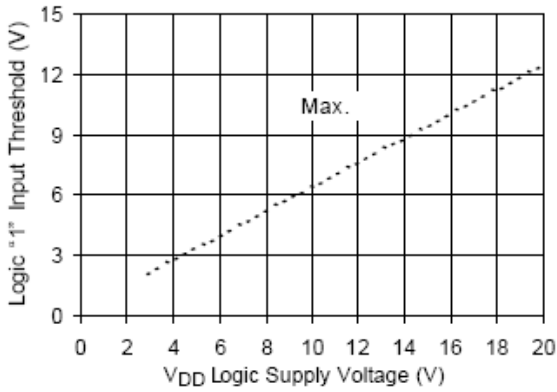

Figure 12B. Logic "1" Input Threshold vs. Voltage

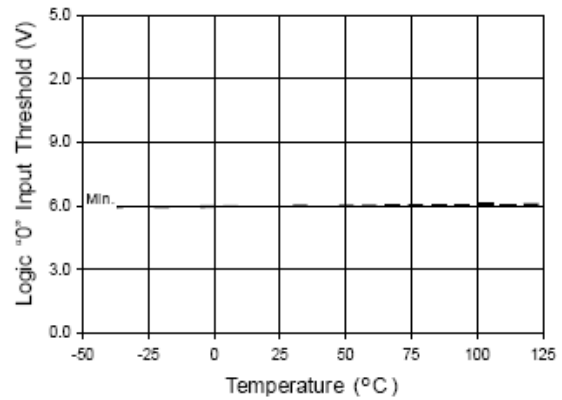

Figure 13A. Logic "0" Input Threshold vs. Temperature

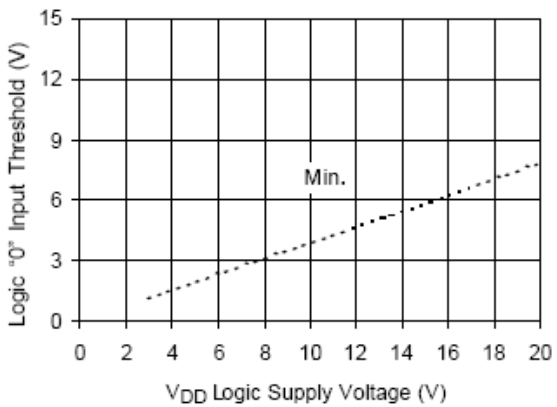

Figure 13B. Logic "0" Input Threshold vs. Voltage

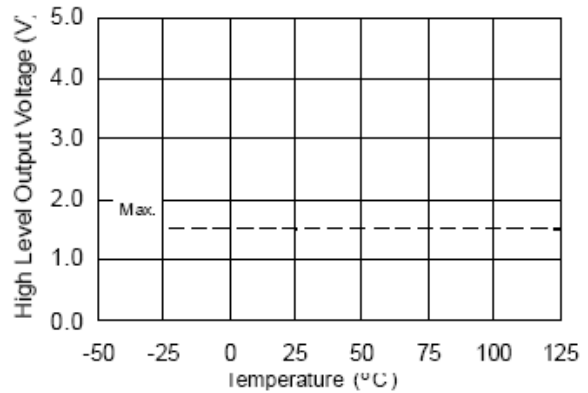

Figure 14A. High Level Output Voltage vs. Temperature ($I_O = 0$ mA)

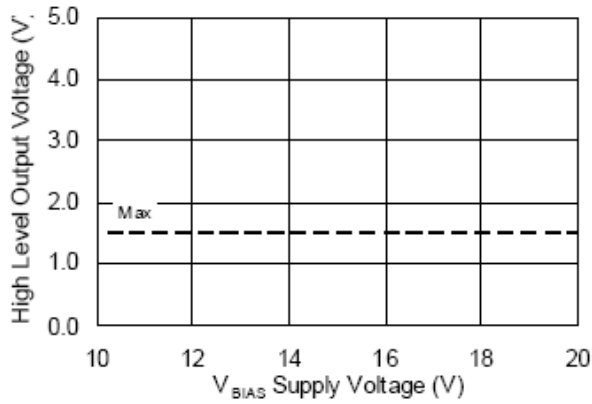

Figure 14B. High Level Output Voltage vs. Supply Voltage ($I_O = 0$ mA)

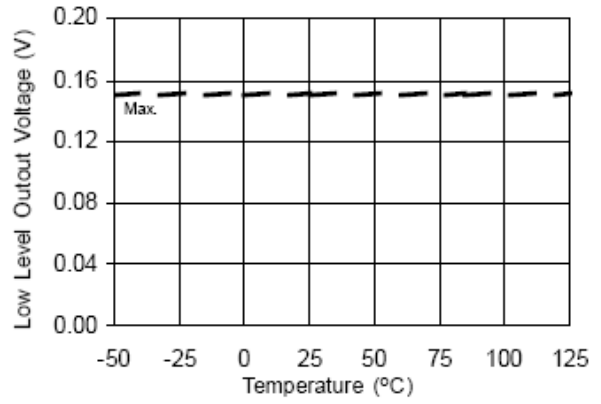

Figure 15A. Low Level Output vs. Temperature

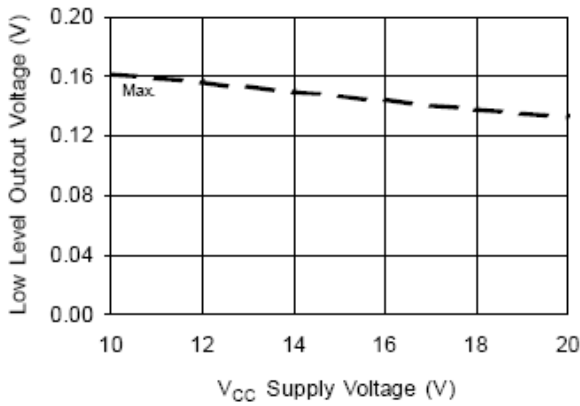

Figure 15B. Low Level Output vs. Supply Voltage

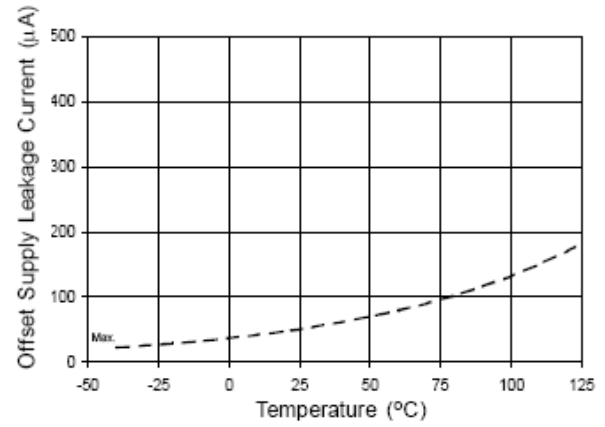

Figure 16A. Offset Supply Current vs. Temperature

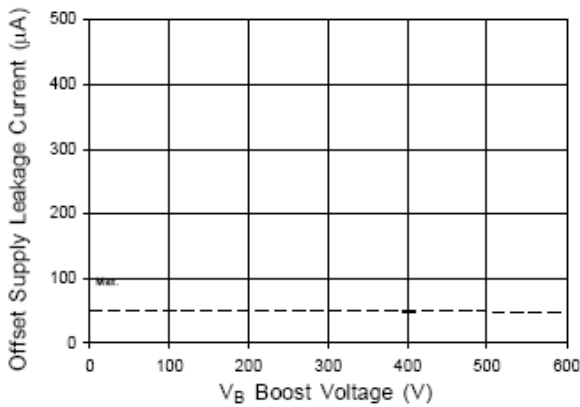

Figure 16B. Offset Supply Current vs. Voltage

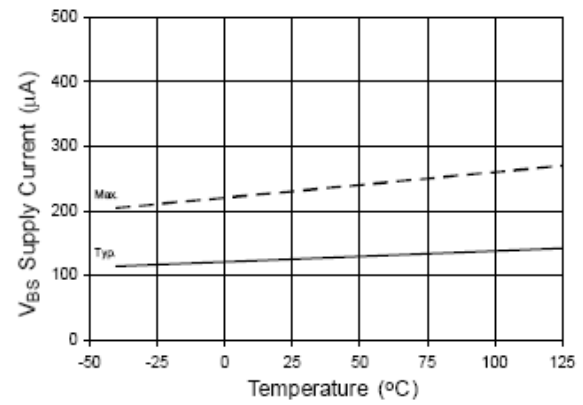

Figure 17A. VBS Supply Current vs. Temperature

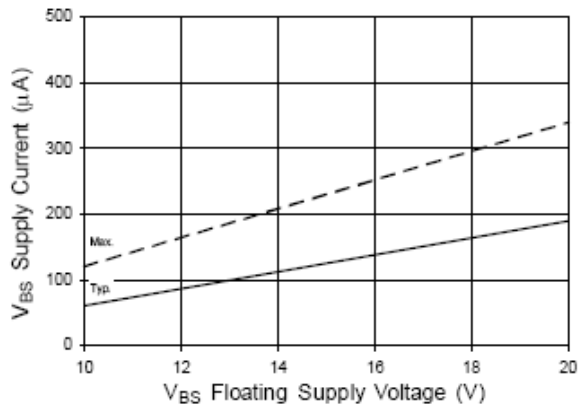

Figure 17B. V_{BS} Supply Current vs. Voltage

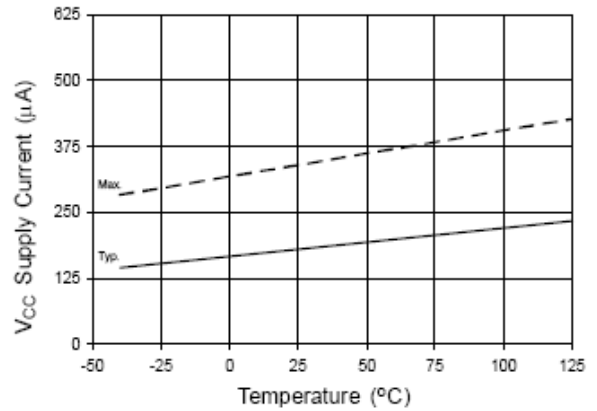

Figure 18A. V_{CC} Supply Current vs. Temperature

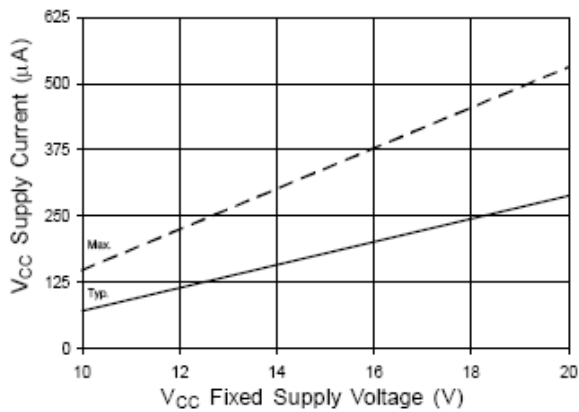

Figure 18B. V_{CC} Supply Current vs. Voltage

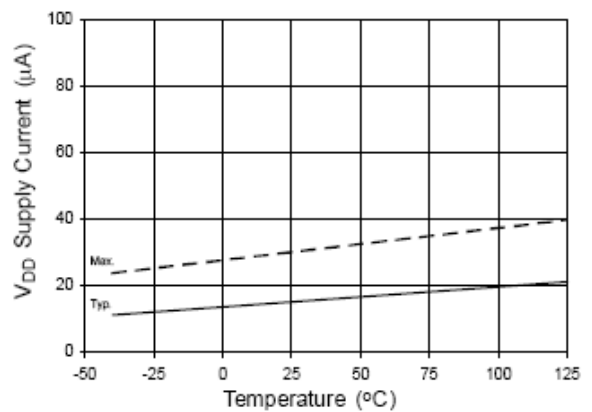

Figure 19A. V_{DD} Supply Current vs. Temperature

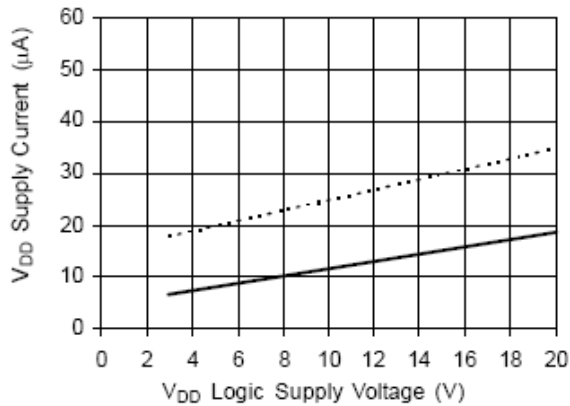

Figure 19B. V_{DD} Supply Current vs. V_{DD} Voltage

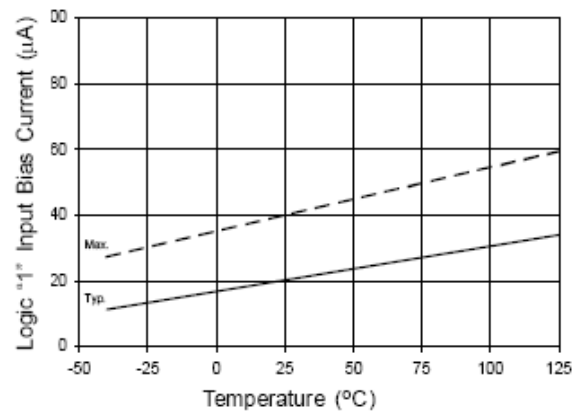

Figure 20A. Logic "1" Input Current vs. Temperature

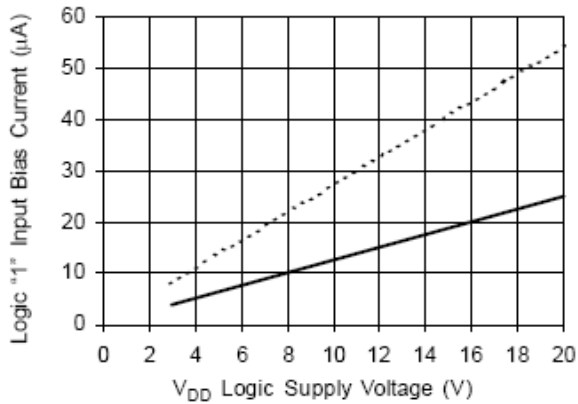

Figure 20B. Logic "1" Input Current vs. V_{DD} Voltage

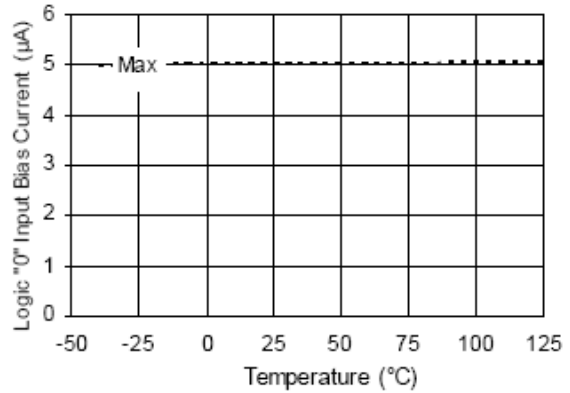

Figure 21A. Logic "0" Input Bias Current vs. Temperature

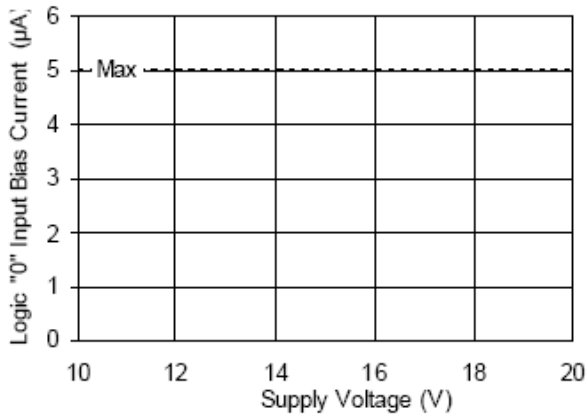

Figure 21B. Logic "0" Input Bias Current vs. Voltage

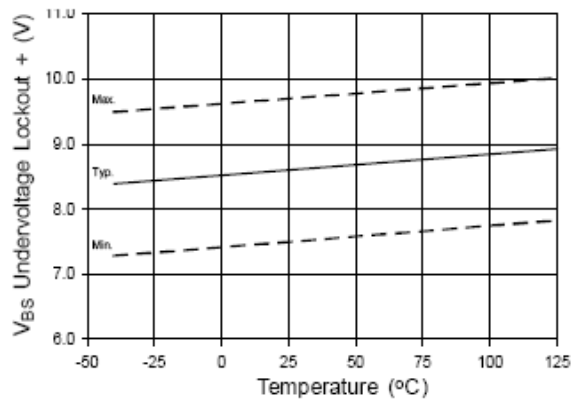

Figure 22. V_{BS} Undervoltage (+) vs. Temperature

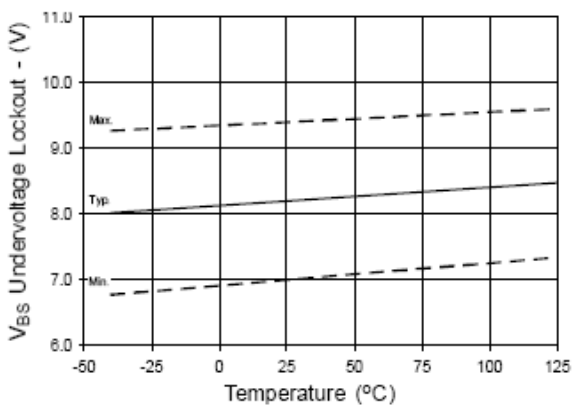

Figure 23. V_{BS} Undervoltage (-) vs. Temperature

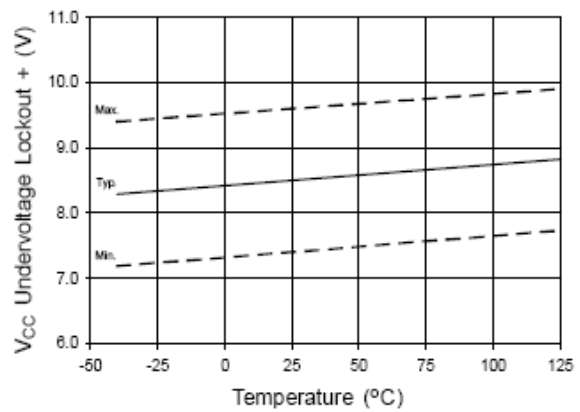

Figure 24. V_{CC} Undervoltage (+) vs. Temperature

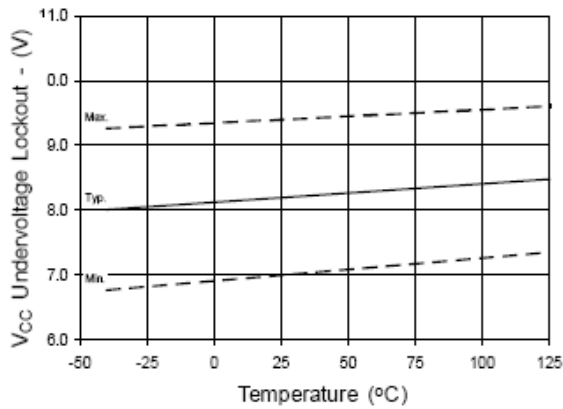

Figure 25. V_{CC} Undervoltage (-) vs. Temperature

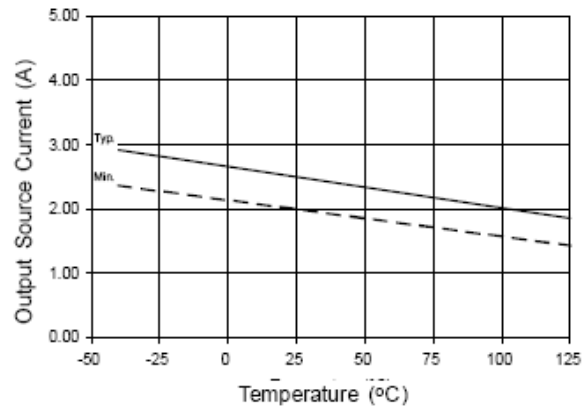

Figure 26A. Output Source Current vs. Temperature

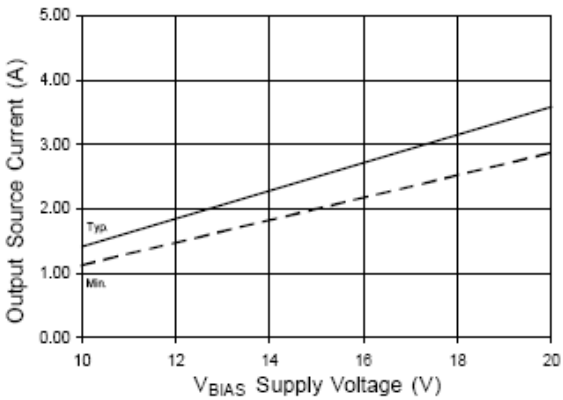

Figure 26B. Output Source Current vs. Voltage

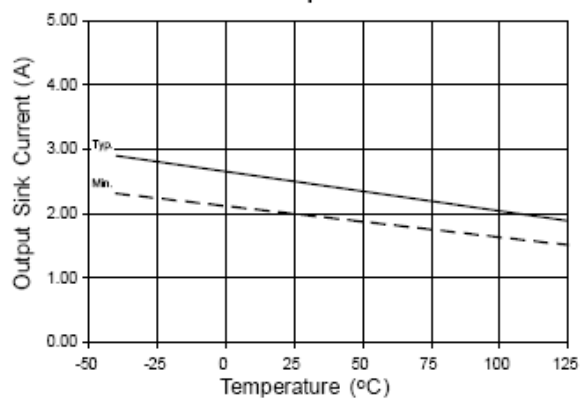

Figure 27A. Output Sink Current vs. Temperature

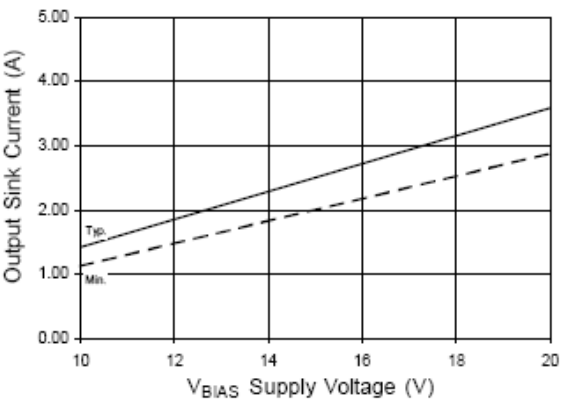

Figure 27B. Output Sink Current vs. Voltage

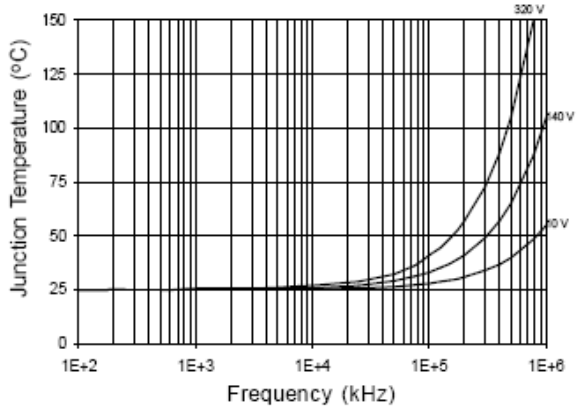

Figure 28. IRS2110/IRS2113 T_J vs. Frequency (IRFBC20) R_{GATE} = 33 Ω, V_{CC} = 15 V

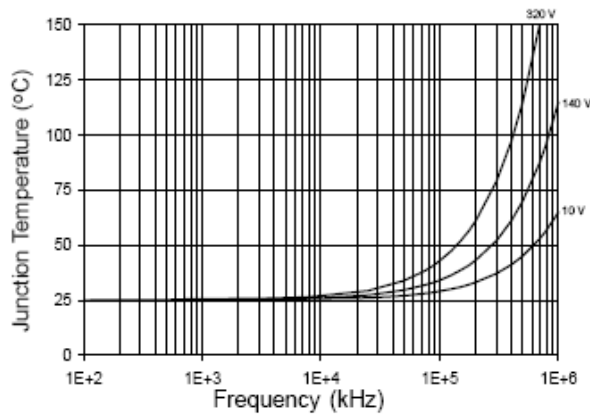

Figure 29. IRS2110/IRS2113 T_J vs. Frequency (IRFBC30) $R_{GATE} = 22 \Omega$, $V_{CC} = 15 V$

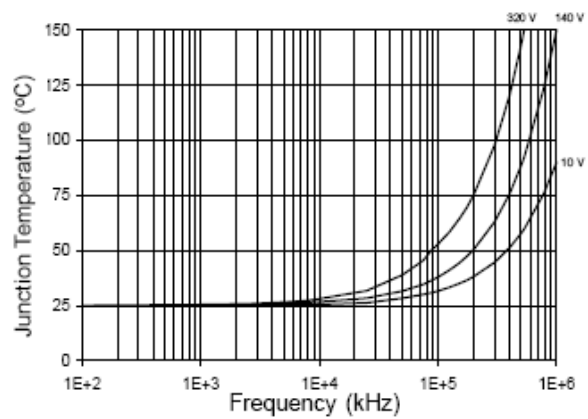

Figure 30. IRS2110/IRS2113 T_J vs. Frequency (IRFBC40) $R_{GATE} = 15 \Omega$, $V_{CC} = 15 V$

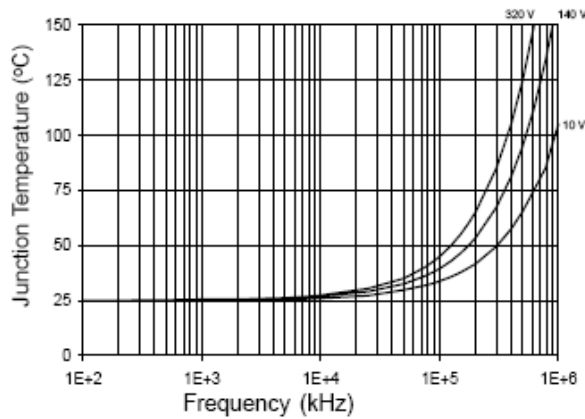

Figure 31. IRS2110/IRS2113 T_J vs. Frequency (IRFPE50) $R_{GATE} = 10 \Omega$, $V_{CC} = 15 V$

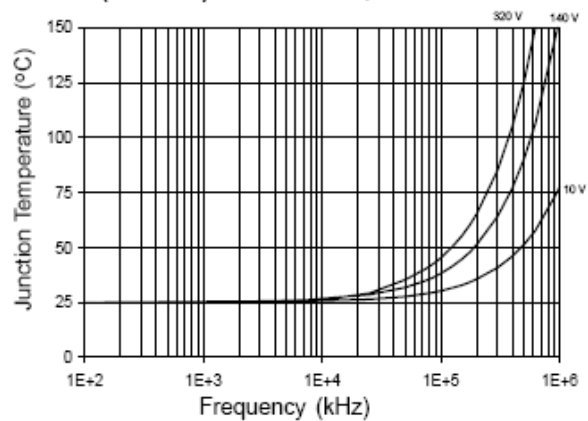

Figure 32. IRS2110S/IRS2113S T_J vs. Frequency (IRFBC20) $R_{GATE} = 33 \Omega$, $V_{CC} = 15 V$

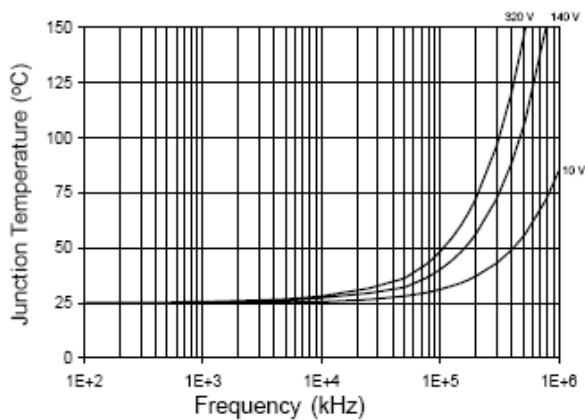

Figure 33. IRS2110S/IRS2113S T_J vs. Frequency (IRFBC30) $R_{GATE} = 22 \Omega$, $V_{CC} = 15 V$

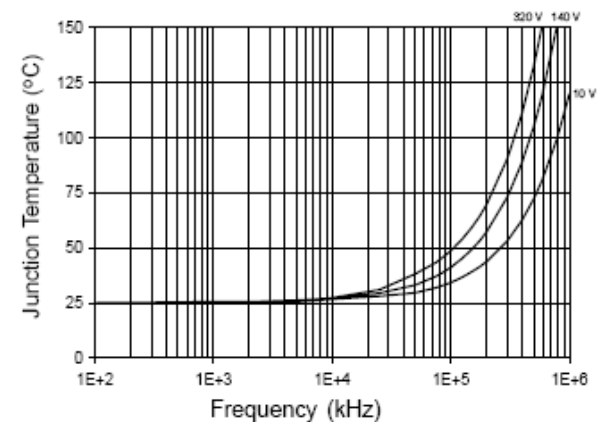

Figure 34. IRS2110S/IRS2113S T_J vs. Frequency (IRFBC40) $R_{GATE} = 15 \Omega$, $V_{CC} = 15 V$

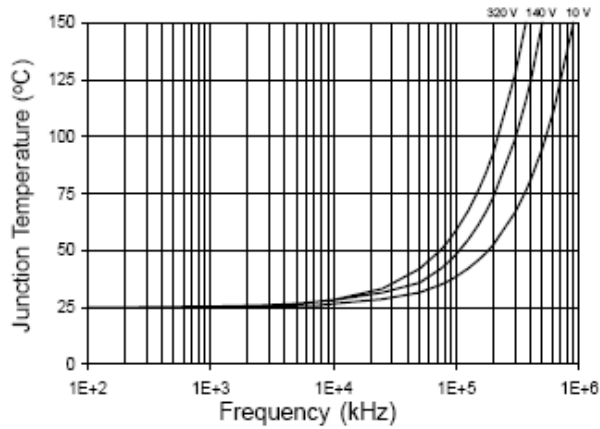

Figure 35. IRS2110S/IRS2113S T_J vs. Frequency (IRFPE50) $R_{GATE} = 10 \Omega$, $V_{CC} = 15 V$

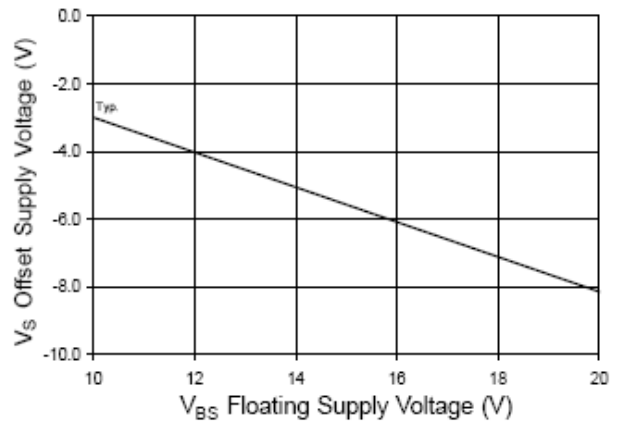

Figure 36. Maximum V_S Negative Offset vs. V_{BS} Supply Voltage

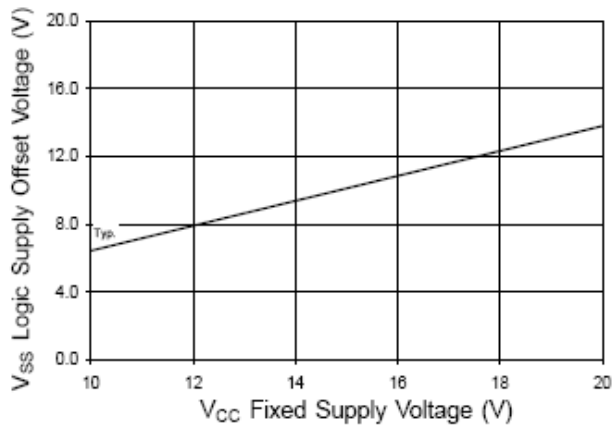
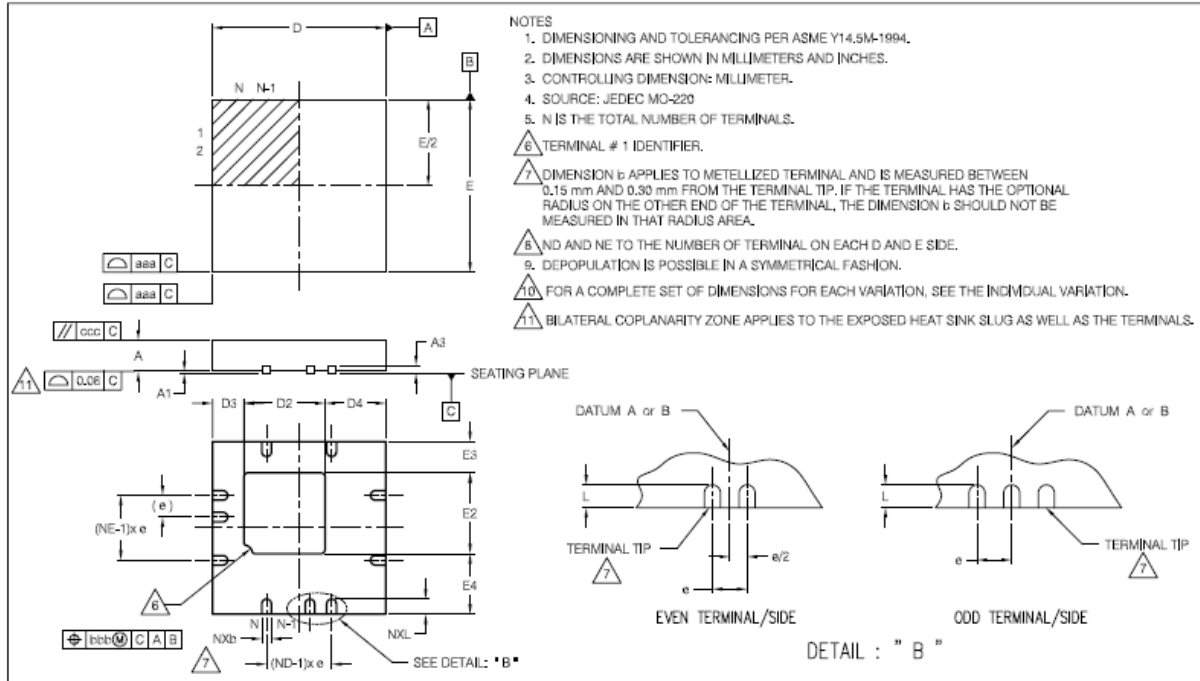

Figure 37. Maximum V_{SS} Positive Offset vs. V_{CC} Supply Voltage

Package Details: MLPQ 4x4 -16L



SYMBOL	VGGD-10					
	MILLIMETERS			INCHES		
	MIN	NOM	MAX	MIN	NOM	MAX
A	0.90	0.90	1.00	.032	.035	.039
A1	0.00	0.02	0.05	.000	.0008	.0019
A3	0.20 REF			.008 REF		
b	0.18	0.25	0.30	.007	.010	.012
D2	1.78	1.88	1.98	.070	.074	.078
D3	0.73 REF			.029 REF		
D4	1.40 REF			.055 REF		
D	4.00 BSC			.157 BSC		
E	4.00 BSC			.157 BSC		
E4	1.40 REF			.055 REF		
E3	0.73 REF			.029 REF		
E2	1.78	1.88	1.98	.070	.074	.078
L	0.30	0.40	0.50	.012	.016	.020
e	0.50 PITCH			.020 PITCH		
N	16			16		
ND	4			4		
NE	4			4		
aaa	0.15			.0059		
bbb	0.10			.0039		
ccc	0.10			.0039		
ddd	0.05			.0019		

Tape and Reel Details: MLPQ 4x4

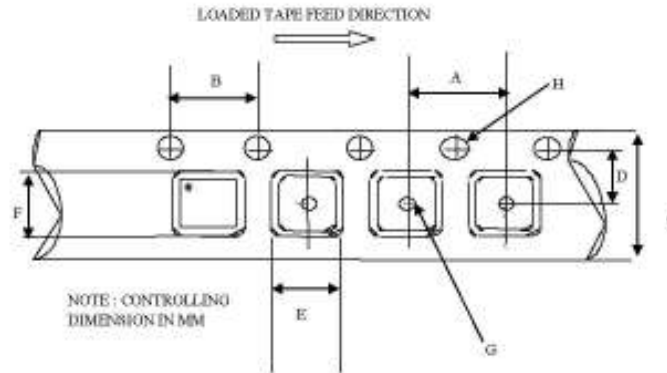

CARRIER TAPE DIMENSION FOR MLPQ4X4V

Code	Metric		Imperial	
	Min	Max	Min	Max
A	7.90	8.10	0.311	0.358
B	3.90	4.10	0.154	0.161
C	11.70	12.30	0.461	0.484
D	5.45	5.55	0.215	0.219
E	4.25	4.45	0.168	0.176
F	4.25	4.45	0.168	0.176
G	1.50	n/a	0.069	n/a
H	1.50	1.60	0.069	0.063

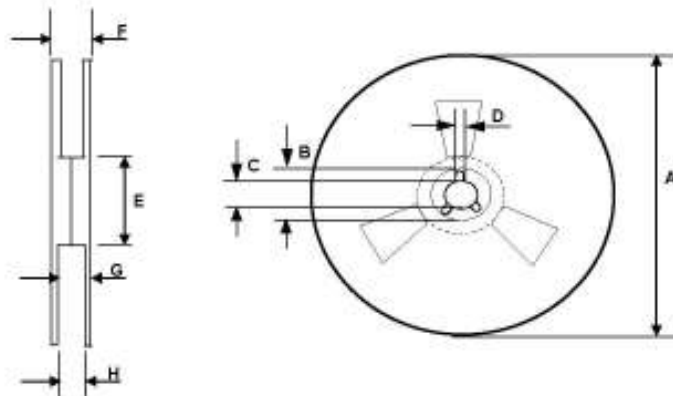

REEL DIMENSIONS FOR MLPQ4X4V

Code	Metric		Imperial	
	Min	Max	Min	Max
A	329.60	330.25	12.976	13.001
B	20.95	21.45	0.824	0.844
C	12.80	13.20	0.503	0.519
D	1.95	2.45	0.767	0.096
E	98.00	102.00	3.858	4.015
F	n/a	18.40	n/a	0.724
G	14.50	17.10	0.570	0.673
H	12.40	14.40	0.488	0.568

Part Marking Information:

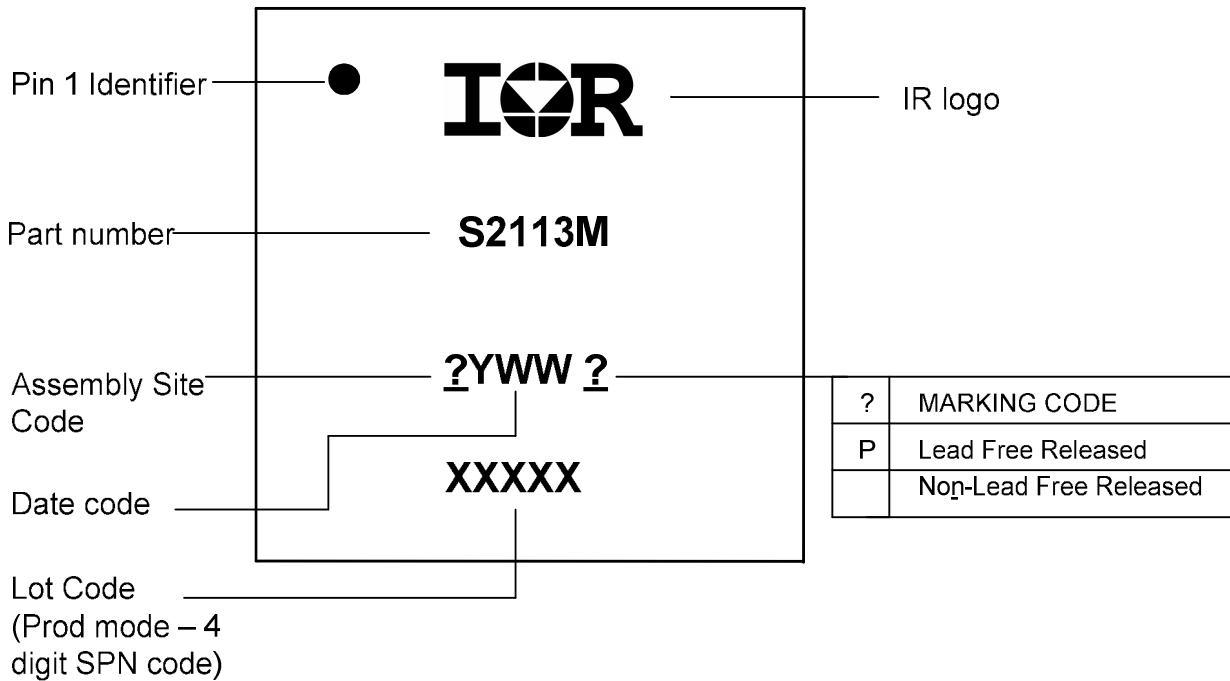

Ordering Information

Base Part Number	Package Type	Standard Pack		Complete Part Number
		Form	Quantity	
IRS2113	MLPQ 4x4-16L	Tube/Bulk	92	IRS2113MPBF
		<i>Tape and Reel</i>	3,000	IRS2113MTRPBF

The information provided in this document is believed to be accurate and reliable. However, International Rectifier assumes no responsibility for the consequences of the use of this information. International Rectifier assumes no responsibility for any infringement of patents or of other rights of third parties which may result from the use of this information. No license is granted by implication or otherwise under any patent or patent rights of International Rectifier. The specifications mentioned in this document are subject to change without notice. This document supersedes and replaces all information previously supplied.

For technical support, please contact IR's Technical Assistance Center
<http://www.irf.com/technical-info/>

WORLD HEADQUARTERS:
 233 Kansas St., El Segundo, California 90245
 Tel: (310) 252-7105

Revision History

Date	Comment
09/24/09	Initial conversion from SO package style data sheet
03/24/2010	Included qual info page
08/08/2011	Update the package details
02/08/2012	Update pin assignment drawing