

**Triple phase leg
CoolMOS™ Power Module**

$V_{DSS} = 600V$
 $R_{DSon} = 21m\Omega$ typ @ $T_j = 25^\circ C$
 $I_D = 116A$ @ $T_c = 25^\circ C$

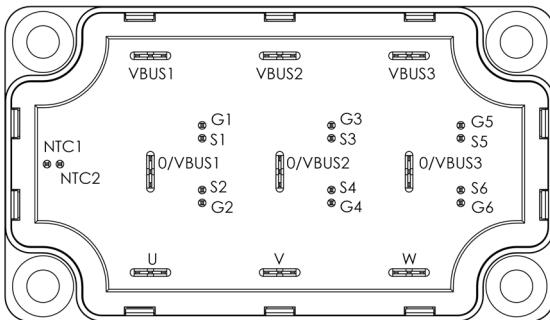
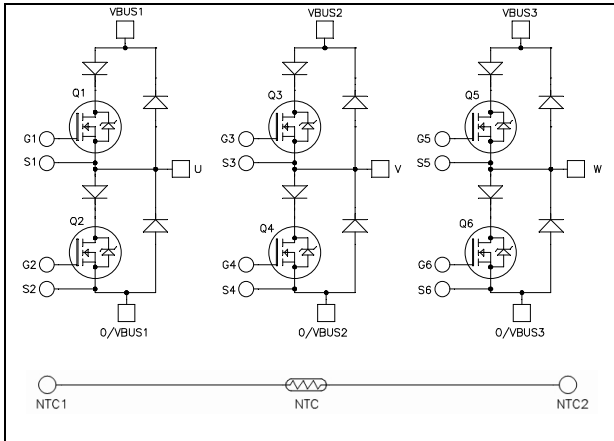

Application

- Welding converters
- Switched Mode Power Supplies
- Uninterruptible Power Supplies
- Motor control

Features

- **CoolMOS™**
 - Ultra low R_{DSon}
 - Low Miller capacitance
 - Ultra low gate charge
 - Avalanche energy rated
 - Very rugged
- **SiC Parallel Schottky Diode**
 - Zero reverse recovery
 - Zero forward recovery
 - Temperature Independent switching behavior
 - Positive temperature coefficient on VF
- Kelvin source for easy drive
- Very low stray inductance
 - Symmetrical design
 - Lead frames for power connections
- High level of integration
- Internal thermistor for temperature monitoring
- AlN substrate for improved thermal performance

Benefits

- Outstanding performance at high frequency operation
- Direct mounting to heatsink (isolated package)
- Low junction to case thermal resistance
- Solderable terminals both for power and signal for easy PCB mounting
- Very low (12mm) profile
- Each leg can be easily paralleled to achieve a phase leg of three times the current capability
- Module can be configured as a three phase bridge
- RoHS Compliant

All ratings @ $T_j = 25^\circ C$ unless otherwise specified

CAUTION: These Devices are sensitive to Electrostatic Discharge. Proper Handling Procedures Should Be Followed. See application note APT0502 on www.microsemi.com

Absolute maximum ratings (Per CoolMOS™)

Symbol	Parameter	Max ratings	Unit
V _{DSS}	Drain - Source Breakdown Voltage	600	V
I _D	Continuous Drain Current	T _c = 25°C	116
		T _c = 80°C	87
I _{DM}	Pulsed Drain current	400	A
V _{GS}	Gate - Source Voltage	±20	V
R _{DS(on)}	Drain - Source ON Resistance	21	mΩ
P _D	Maximum Power Dissipation	T _c = 25°C	625
I _{AR}	Avalanche current (repetitive and non repetitive)	13	A
E _{AR}	Repetitive Avalanche Energy	3	mJ
E _{AS}	Single Pulse Avalanche Energy	1950	

Electrical Characteristics (Per CoolMOS™)

Symbol	Characteristic	Test Conditions	Min	Typ	Max	Unit
I _{DSS}	Zero Gate Voltage Drain Current	V _{GS} = 0V, V _{DS} = 600V			200	μA
R _{DS(on)}	Drain – Source on Resistance	V _{GS} = 10V, I _D = 88A		18.5	21	mΩ
V _{GS(th)}	Gate Threshold Voltage	V _{GS} = V _{DS} , I _D = 6mA	2.4	3	3.6	V
I _{GSS}	Gate – Source Leakage Current	V _{GS} = ±20 V, V _{DS} = 0V			200	nA

Dynamic Characteristics (Per CoolMOS™)

Symbol	Characteristic	Test Conditions	Min	Typ	Max	Unit
C _{iss}	Input Capacitance	V _{GS} = 0V ; V _{DS} = 100V		13		nF
C _{oss}	Output Capacitance	f = 1MHz		0.72		
Q _g	Total gate Charge	V _{GS} = 10V V _{Bus} = 480V I _D = 88A		580		nC
Q _{gs}	Gate – Source Charge			72		
Q _{gd}	Gate – Drain Charge			300		
T _{d(on)}	Turn-on Delay Time	Inductive Switching @ 25°C V _{GS} = 13V V _{Bus} = 400V I _D = 88A R _G = 0.8Ω		23		ns
T _r	Rise Time			10		
T _{d(off)}	Turn-off Delay Time			130		
T _f	Fall Time			7		
E _{on}	Turn-on Switching Energy	Inductive switching @ 125°C V _{GS} = 13V, V _{Bus} = 400V I _D = 88A, R _G = 0.8Ω		1.2		mJ
E _{off}	Turn-off Switching Energy			2.8		
R _{thJC}	Junction to Case Thermal Resistance				0.20	°C/W

Series diode ratings and characteristics (Per series diode)

Symbol	Characteristic	Test Conditions		Min	Typ	Max	Unit
V _{RRM}	Maximum Repetitive Reverse Voltage			600			V
I _{RM}	Maximum Reverse Leakage Current	V _R = 600V				100	μA
I _F	DC Forward Current				75		A
V _F	Diode Forward Voltage	I _F = 75A	T _j = 25°C		1.6	2	V
			T _j = 150°C		1.5		
t _{rr}	Reverse Recovery Time	I _F = 75A V _R = 300V di/dt = 2000A/μs	T _j = 25°C		100		ns
			T _j = 150°C		150		
Q _{rr}	Reverse Recovery Charge	I _F = 75A V _R = 300V di/dt = 2000A/μs	T _j = 25°C		3.6		nC
			T _j = 150°C		7.6		
R _{thJC}	Junction to Case Thermal Resistance					0.80	°C/W

SiC Parallel diode ratings and characteristics (Per parallel diode)

Symbol	Characteristic	Test Conditions		Min	Typ	Max	Unit
V _{RRM}	Maximum Peak Repetitive Reverse Voltage			600			V
I _{RM}	Maximum Reverse Leakage Current	V _R = 600V	T _j = 25°C		30	180	μA
			T _j = 175°C		60	900	
I _F	DC Forward Current				30		A
V _F	Diode Forward Voltage	I _F = 30A	T _j = 25°C		1.6	1.8	V
			T _j = 175°C		2	2.4	
Q _C	Total Capacitive Charge	I _F = 30A, V _R = 600V di/dt = 1000A/μs			84		nC
C	Total Capacitance	f = 1MHz, V _R = 200V			195		pF
		f = 1MHz, V _R = 400V			150		
R _{thJC}	Junction to Case Thermal Resistance					0.80	°C/W

Thermal and package characteristics

Symbol	Characteristic			Min	Typ	Max	Unit
V _{ISOL}	RMS Isolation Voltage, any terminal to case t = 1 min, 50/60Hz			4000			V
T _J	Operating junction temperature range			-40		150*	°C
T _{STG}	Storage Temperature Range			-40		125	
T _C	Operating Case Temperature			-40		100	
Torque	Mounting torque	To heatsink	M6	3		5	N.m
Wt	Package Weight					250	g

* T_j = 175°C for series and parallel diodes

Temperature sensor NTC (see application note APT0406 on www.microsemi.com for more information).

Pins NTC1 & NTC2 are only mounted on APTM100TA35SCTPG power module.

Symbol	Characteristic	Min	Typ	Max	Unit
R ₂₅	Resistance @ 25°C		50		kΩ
ΔR ₂₅ /R ₂₅			5		%
B _{25/85}	T ₂₅ = 298.15 K		3952		K
ΔB/B			4		%

$$R_T = \frac{R_{25}}{\exp\left[B_{25/85}\left(\frac{1}{T_{25}} - \frac{1}{T}\right)\right]}$$

T: Thermistor temperature
 R_T: Thermistor value at T

SP6-P Package outline (dimensions in mm)

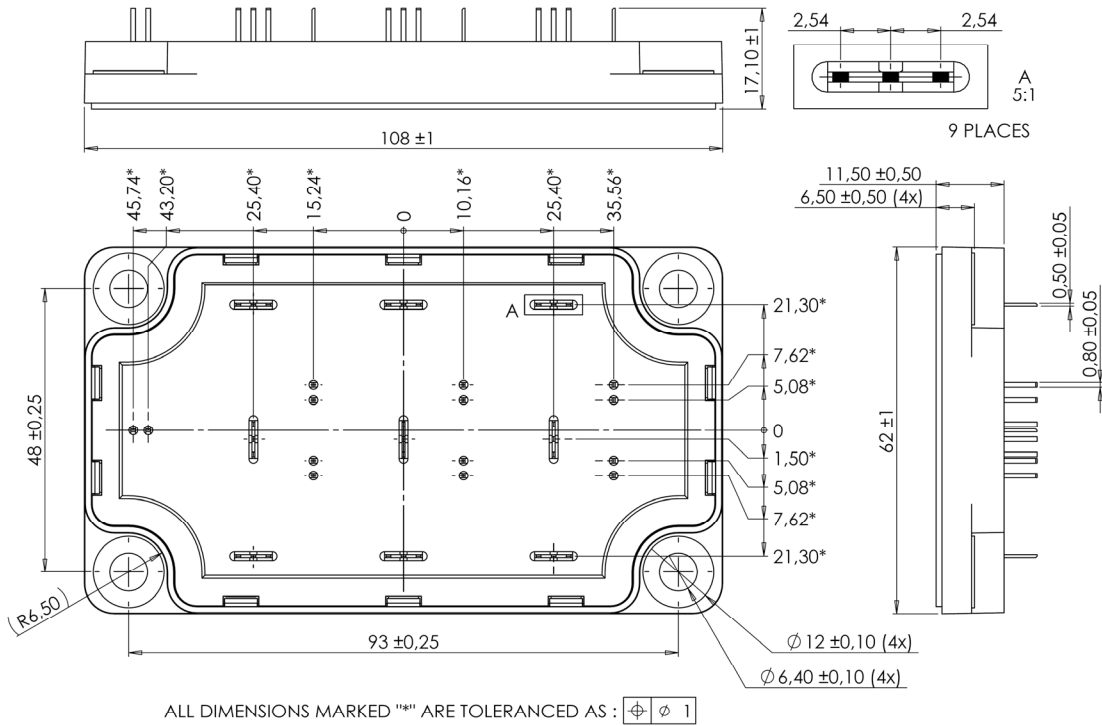

See application note 1902 - Mounting Instructions for SP6-P (12mm) Power Modules on www.microsemi.com

Typical CoolMOS™ Performance Curve

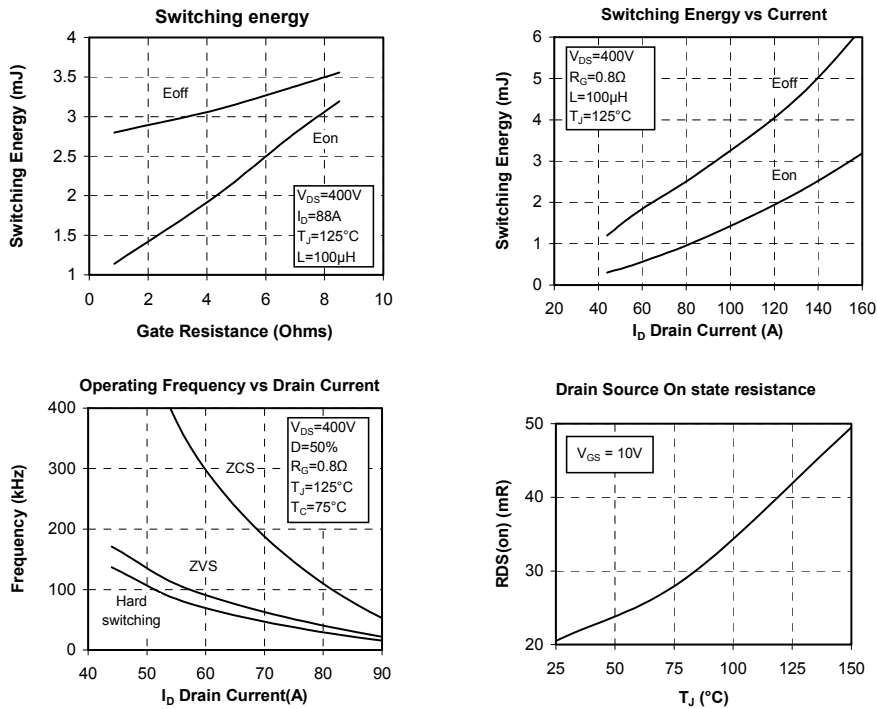

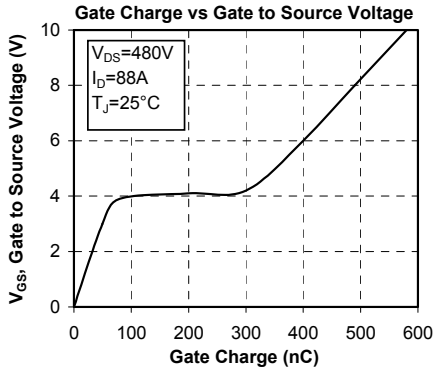
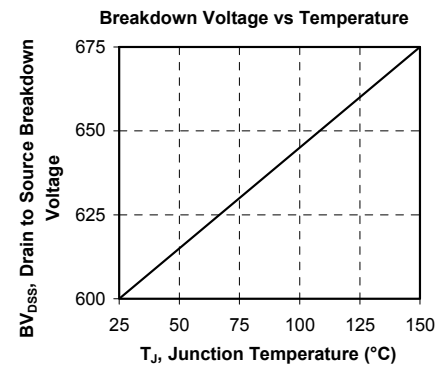
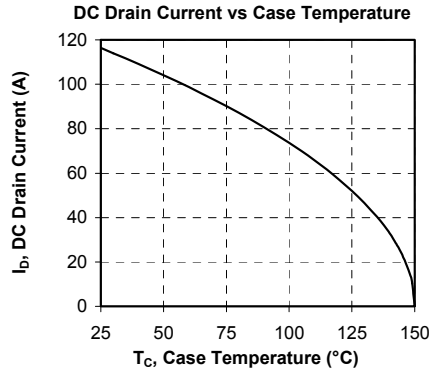
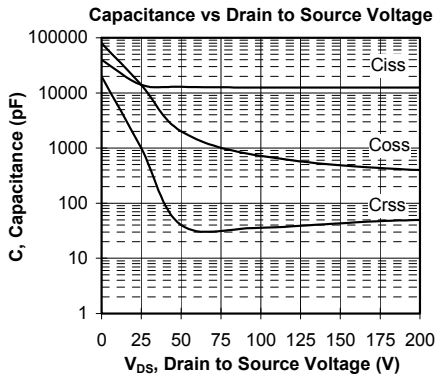
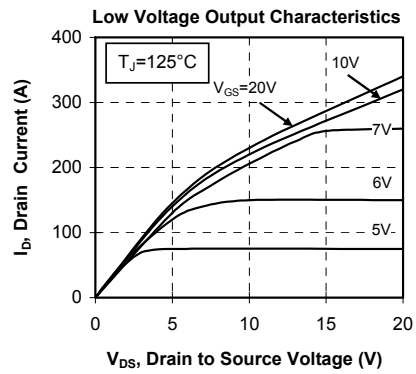
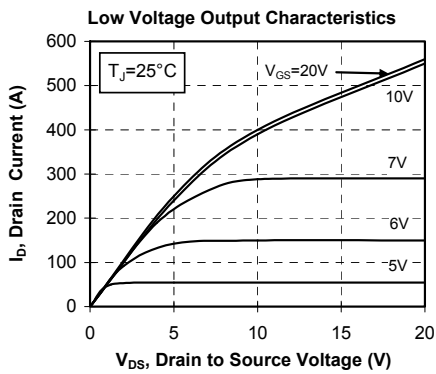
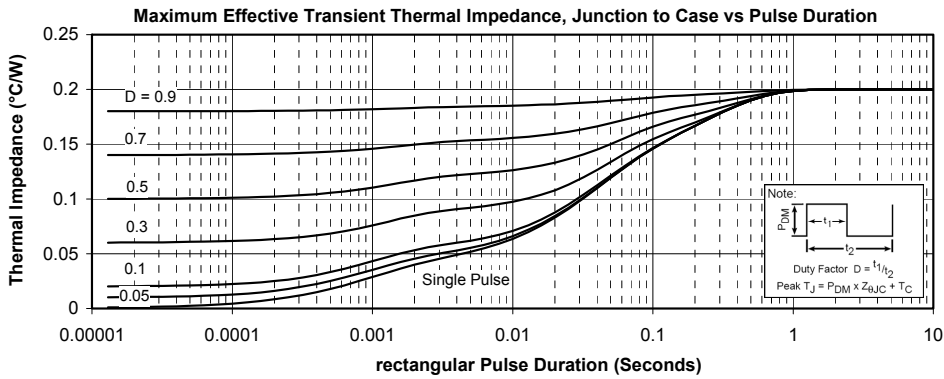

Typical series diode Performance Curve

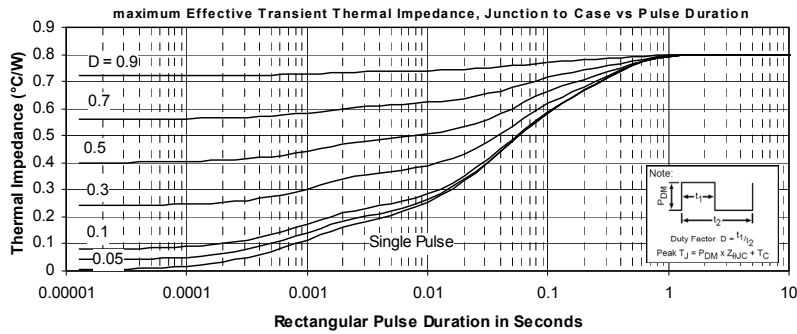
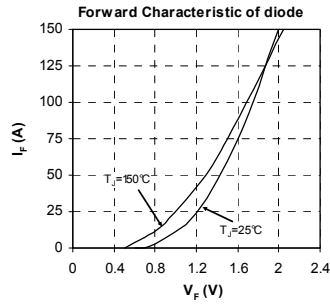

Typical SiC parallel diode Performance Curve

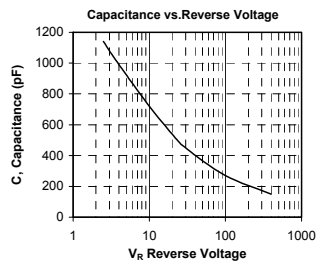
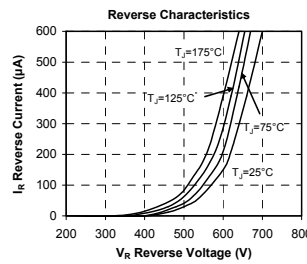
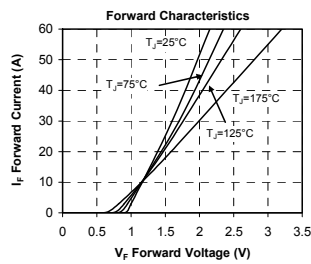
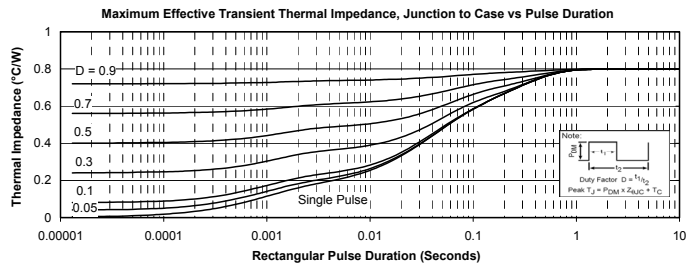

Thermal impedance ; CoolMOS™

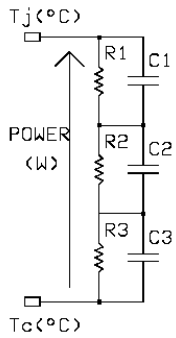

RC Final Model

- R1 = 0.044 Ω
- R2 = 0.103 Ω
- R3 = 0.053 Ω
- C1 = 0.022 F
- C2 = 0.347 F
- C3 = 4.31 F

Thermal impedance ; Series diode

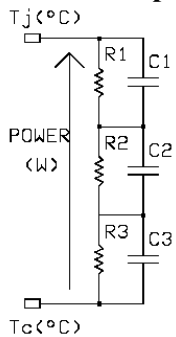

RC Final Model

- R1 = 0.176 Ω
- R2 = 0.413 Ω
- R3 = 0.211 Ω
- C1 = 0.0055 F
- C2 = 0.086 F
- C3 = 1.07 F

Thermal impedance ; SiC Parallel diode

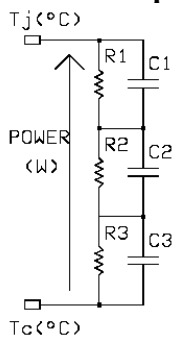

RC Final Model

- R1 = 0.176 Ω
- R2 = 0.413 Ω
- R3 = 0.211 Ω
- C1 = 0.0055 F
- C2 = 0.086 F
- C3 = 1.07 F

DISCLAIMER

The information contained in the document (unless it is publicly available on the Web without access restrictions) is PROPRIETARY AND CONFIDENTIAL information of Microsemi and cannot be copied, published, uploaded, posted, transmitted, distributed or disclosed or used without the express duly signed written consent of Microsemi. If the recipient of this document has entered into a disclosure agreement with Microsemi, then the terms of such Agreement will also apply. This document and the information contained herein may not be modified, by any person other than authorized personnel of Microsemi. No license under any patent, copyright, trade secret or other intellectual property right is granted to or conferred upon you by disclosure or delivery of the information, either expressly, by implication, inducement, estoppels or otherwise. Any license under such intellectual property rights must be approved by Microsemi in writing signed by an officer of Microsemi.

Microsemi reserves the right to change the configuration, functionality and performance of its products at anytime without any notice. This product has been subject to limited testing and should not be used in conjunction with life-support or other mission-critical equipment or applications. Microsemi assumes no liability whatsoever, and Microsemi disclaims any express or implied warranty, relating to sale and/or use of Microsemi products including liability or warranties relating to fitness for a particular purpose, merchantability, or infringement of any patent, copyright or other intellectual property right. Any performance specifications believed to be reliable but are not verified and customer or user must conduct and complete all performance and other testing of this product as well as any user or customers final application. User or customer shall not rely on any data and performance specifications or parameters provided by Microsemi. It is the customer's and user's responsibility to independently determine suitability of any Microsemi product and to test and verify the same. The information contained herein is provided "AS IS, WHERE IS" and with all faults, and the entire risk associated with such information is entirely with the User. Microsemi specifically disclaims any liability of any kind including for consequential, incidental and punitive damages as well as lost profit. The product is subject to other terms and conditions which can be located on the web at <http://www.microsemi.com/legal/tnc.asp>

Life Support Application

Seller's Products are not designed, intended, or authorized for use as components in systems intended for space, aviation, surgical implant into the body, in other applications intended to support or sustain life, or for any other application in which the failure of the Seller's Product could create a situation where personal injury, death or property damage or loss may occur (collectively "Life Support Applications").

Buyer agrees not to use Products in any Life Support Applications and to the extent it does it shall conduct extensive testing of the Product in such applications and further agrees to indemnify and hold Seller, and its officers, employees, subsidiaries, affiliates, agents, sales representatives and distributors harmless against all claims, costs, damages and expenses, and attorneys' fees and costs arising, directly or indirectly, out of any claims of personal injury, death, damage or otherwise associated with the use of the goods in Life Support Applications, even if such claim includes allegations that Seller was negligent regarding the design or manufacture of the goods.

Buyer must notify Seller in writing before using Seller's Products in Life Support Applications. Seller will study with Buyer alternative solutions to meet Buyer application specification based on Sellers sales conditions applicable for the new proposed specific part.