

### SpicePlus

Like spice, its diminutive size is a stark contrast to its standout performance in terms of brightness, durability and reliability. Despite being the smallest in size yet the SpicePlus packs a powerful performance and is a highly reliable design device.



### Features:

- > Super high brightness surface mount LED automotive exterior applications.
- > 120° viewing angle.
- > Compact package outline (LxW) of 2.5 x 2.0mm.
- > Ultra low height profile - 0.7mm.
- > Low thermal resistance.
- > Superior corrosion robustness.
- > Compatible to IR reflow soldering.
- > Compliance to automotive standard; AEC-Q101.
- > Environmental friendly; RoHS compliance.



### Applications:

- > Automotive: Exterior application: eg: Daytime Running Light (DRL), Position Lamp, Fog lamp, Backup Lamp.

**Electrical Characteristics at Tj=25°C**

Part Ordering Number	Color	Viewing Angle°	Luminous Flux @ 200mA (lm) <i>Appx. 1.2</i>		
			Min.	Typ.	Max.
SPW-VZHG-SU2-VNBN	White	120	51.7	65.0	99.4

**Electrical Characteristics at Tj=25°C**

Part Number	Vf @ If = 200mA <i>Appx. 3.1</i>		
	Min. (V)	Typ. (V)	Max. (V)
SPW-VZHG	3.0	3.3	3.8

**Absolute Maximum Ratings**

	Maximum Value	Unit
DC forward current	300	mA
Peak pulse current; (tp ≤ 10µs, Duty cycle = 0.1)	600	mA
Reverse voltage; Ir <sub>max</sub> = 10µA	Not designed for reverse bias	V
ESD threshold (HBM)	8	KV
LED junction temperature	150	°C
Operating temperature	-40 ... +125	°C
Storage temperature	-40 ... +125	°C
Thermal resistance		
- Real Thermal Resistance		
Junction / solder point, R <sub>th JS real</sub> (typ = 18)	20	K/W
- Electrical Thermal Resistance		
Junction / solder point, R <sub>th JS el</sub> (typ = 13)	14	K/W
(Mounting on DOMINANT standard PCB)		

**Color Grouping** *Appx. 2.1*

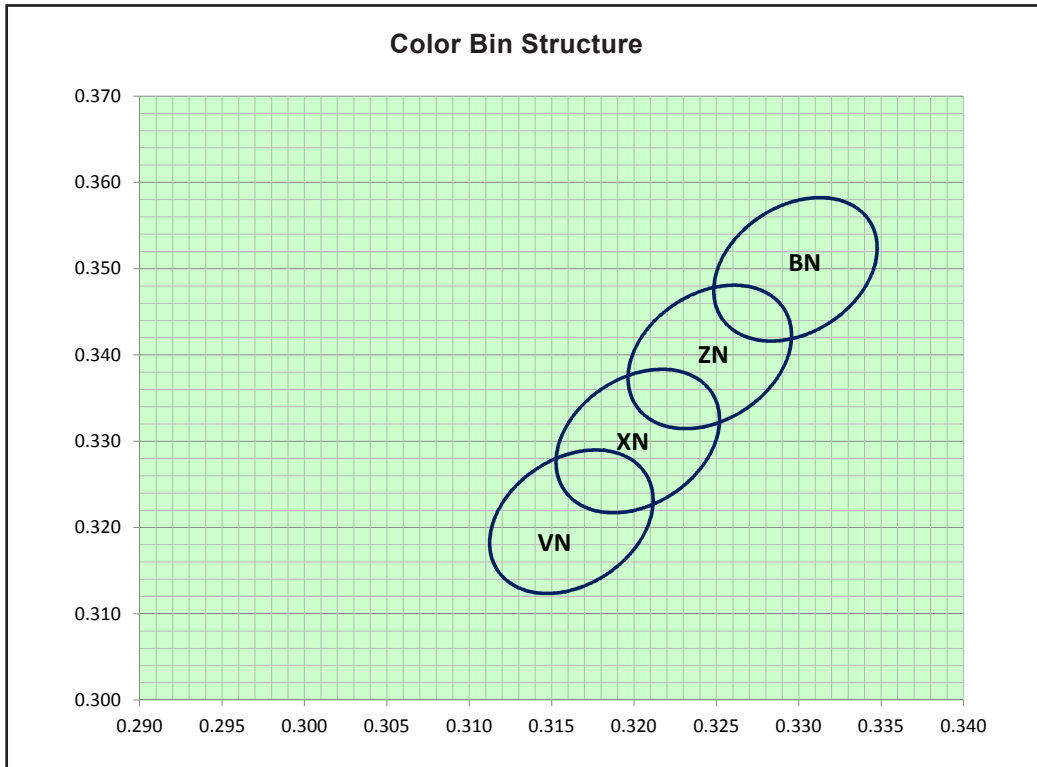

Bin	Ellipse	x	y	a	b	θ °
BN	5 Step	0.3298	0.3499	0.0085	0.00463	75.57
ZN	5 Step	0.3246	0.3398	0.0085	0.00463	75.57
XN	5 Step	0.3202	0.3300	0.0085	0.00463	75.57
VN	5 Step	0.3162	0.3207	0.0085	0.00463	75.57

InGaN wavelength is very sensitive to drive current. Operating at lower current is not recommended and may yield unpredictable performance current pulsing should be used for dimming purposed.

**Luminous Intensity Group at Tj=25°C**

Brightness Group	Luminous Flux <sup>Appx. 1.2</sup> (lm)
S2	51.7 ... 59.0
S3	59.0 ... 67.2
T2	67.2 ... 76.5
T3	76.5 ... 87.4
U2	87.4 ... 99.4

**Vf Bining (Optional)**

Vf Bin @ 200 mA	Forward Voltage (V) <sup>Appx. 3.1</sup>
VH9	3.00 ... 3.20
VJ1	3.20 ... 3.40
VJ2	3.40 ... 3.60
VJ3	3.60 ... 3.80

Please consult sales and marketing for special part number to incorporate Vf bining.

**Relative Luminous Flux Vs Forward Current**

$\Phi_v/\Phi_v(200\text{mA}) = f(I_F); T_j = 25^\circ\text{C}$

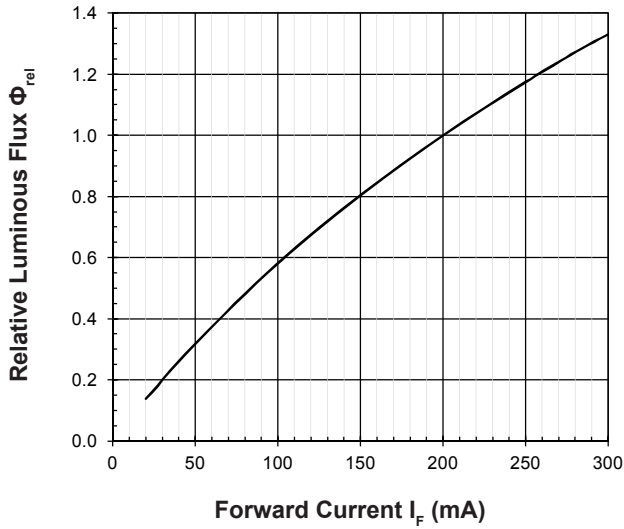

**Forward Current Vs Forward Voltage**

$I_F = f(V_F); T_j = 25^\circ\text{C}$

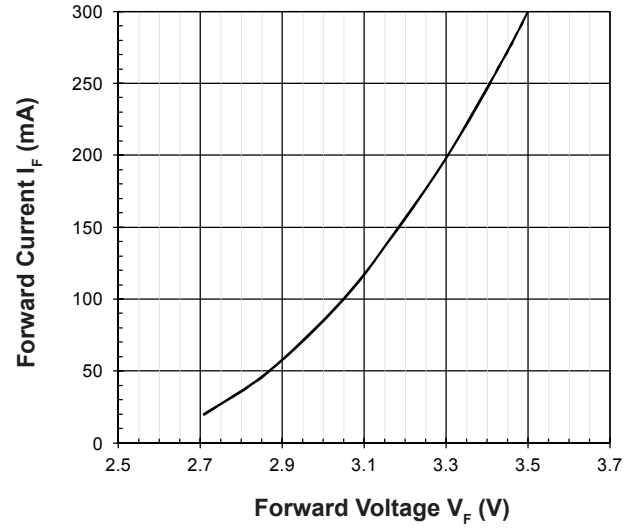

**Maximum Current Vs Temperature**

$I_F = f(T)$

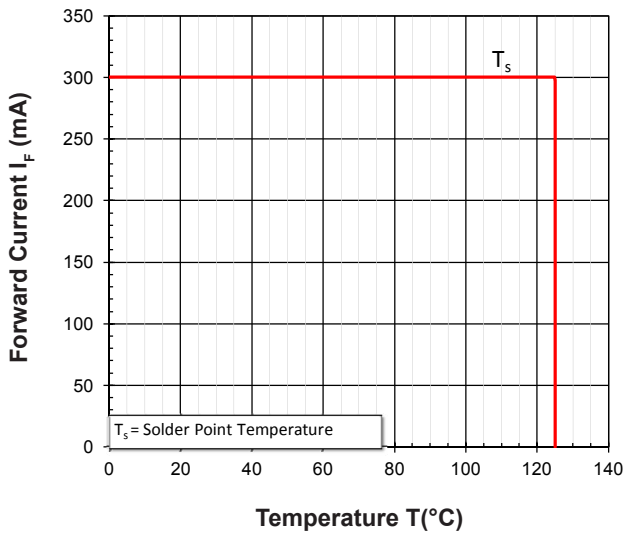

**Relative Spectral Emission**

$\Phi_{rel} = f(\lambda); T_j = 25^\circ\text{C}; I_F = 200\text{mA}$

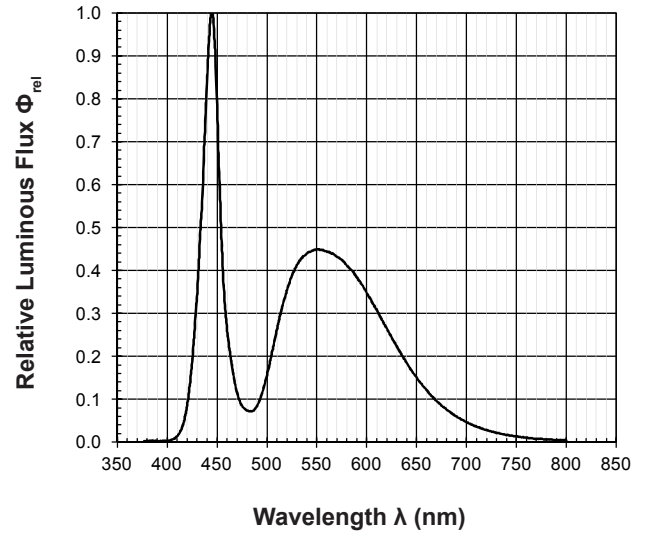

**Chromaticity Coordinate Shift Vs Forward Current**

$\Delta Cx, \Delta Cy = f(I_F); T_j = 25^\circ\text{C}$

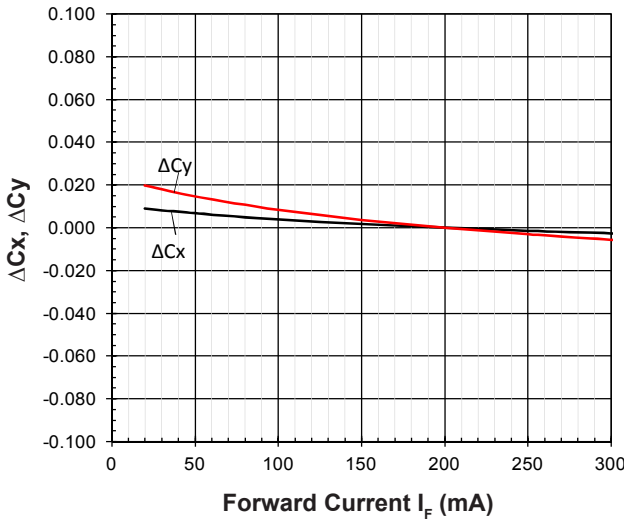

**Allowable Forward Current Vs Duty Ratio**

$(T_j = 25^\circ\text{C}; t_p \leq 10\mu\text{s})$

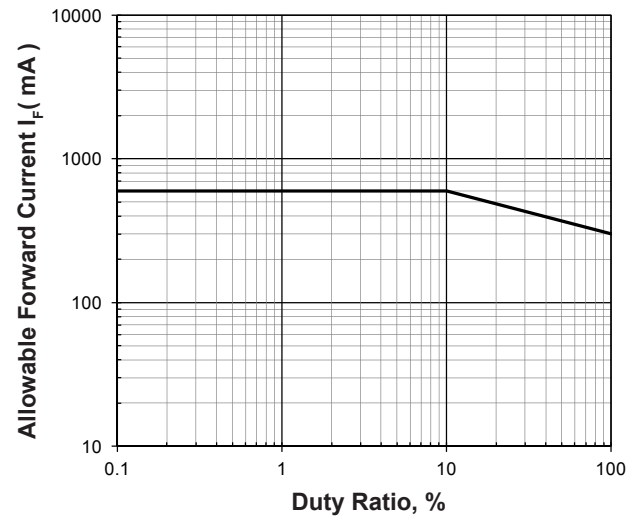

**Radiation Pattern**

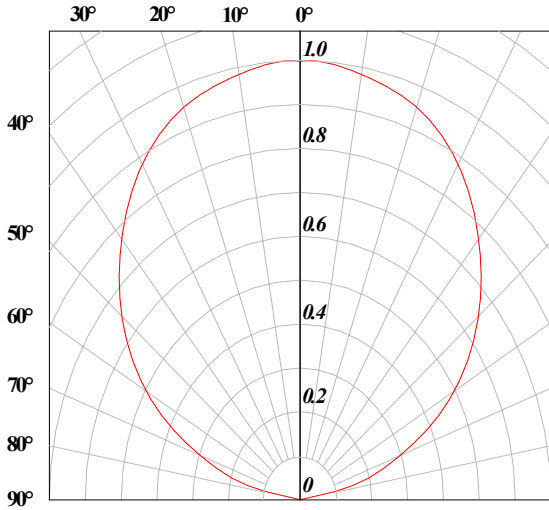

**Relative Forward Voltage Vs Junction Temperature**

$\Delta V_F = V_F - V_F(25^\circ\text{C}) = f(T_j); I_F = 200\text{mA}$

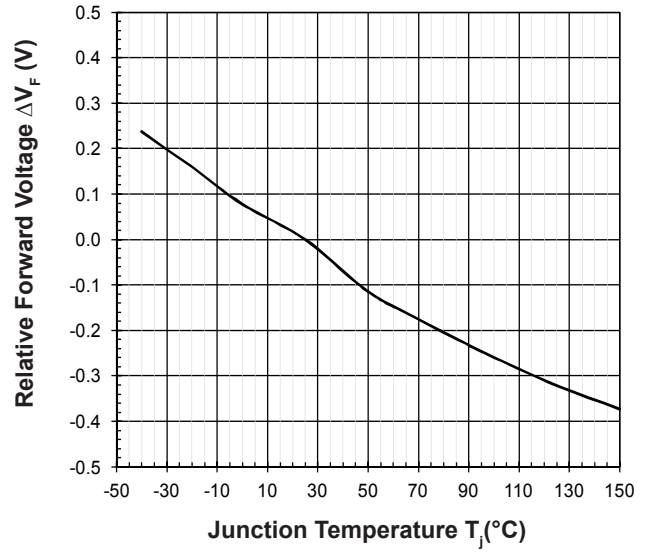

**Relative Luminous Flux Vs Junction Temperature**

$\Phi_V/\Phi_V(25^\circ\text{C}) = f(T_j); I_F = 200\text{mA}$

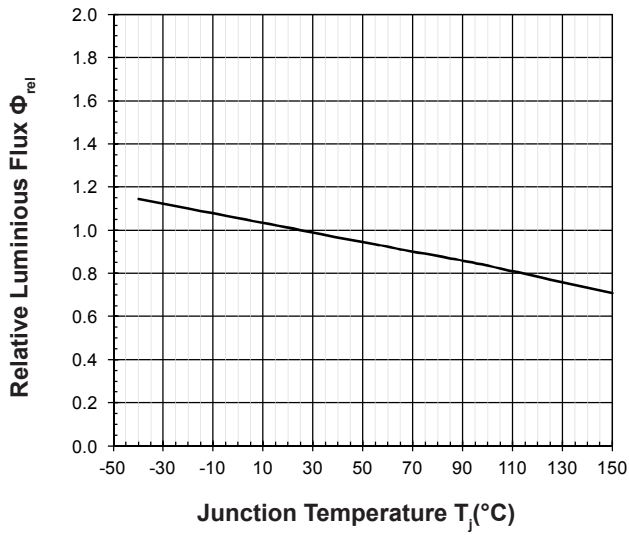

**Chromaticity Coordinate Shift Vs Junction Temperature**

$\Delta C_x, \Delta C_y = f(T_j); I_F = 200\text{mA}$

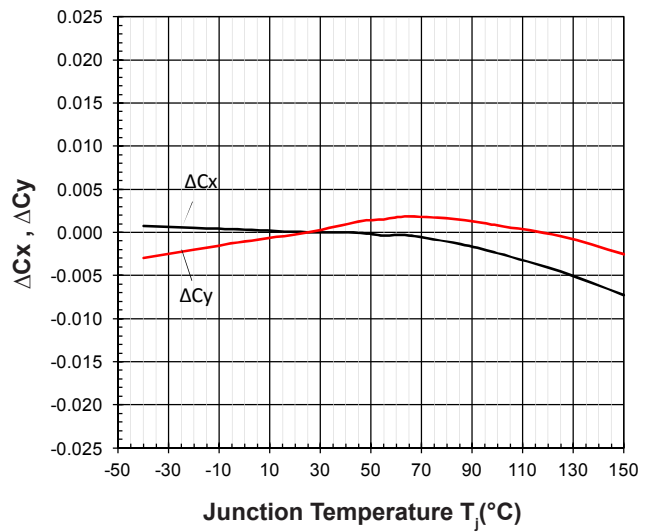

**SpicePlus 2520 White : SPW-VZHG Package Outlines**

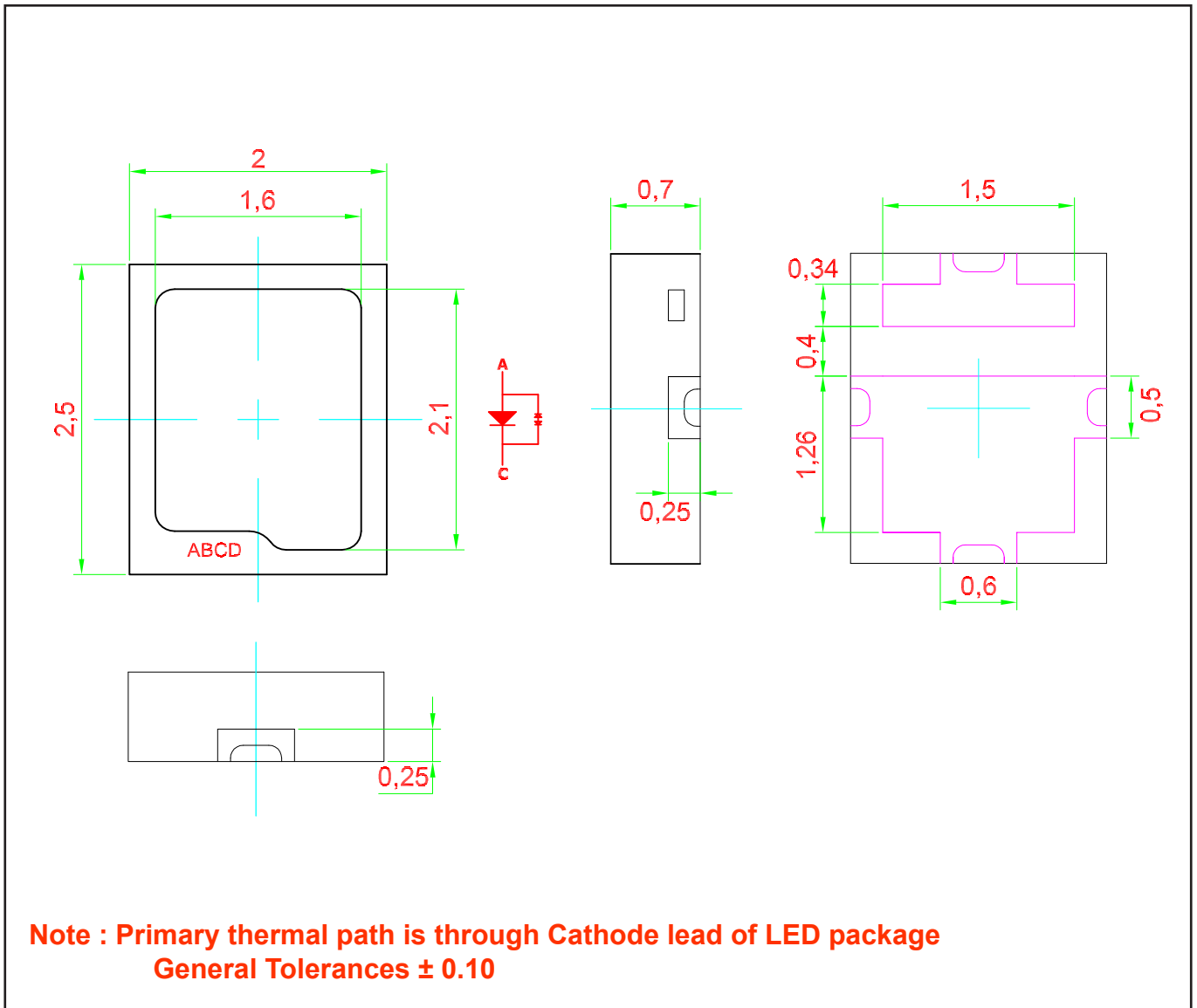

**Material**

Material	
Lead-frame	Cu Alloy With Au Plating
Package	Heat Resistant Polymer
Encapsulant	Silicone Resin
Soldering Leads	Au Plating

Note: product is Pb free

**Recommended Solder Pad**

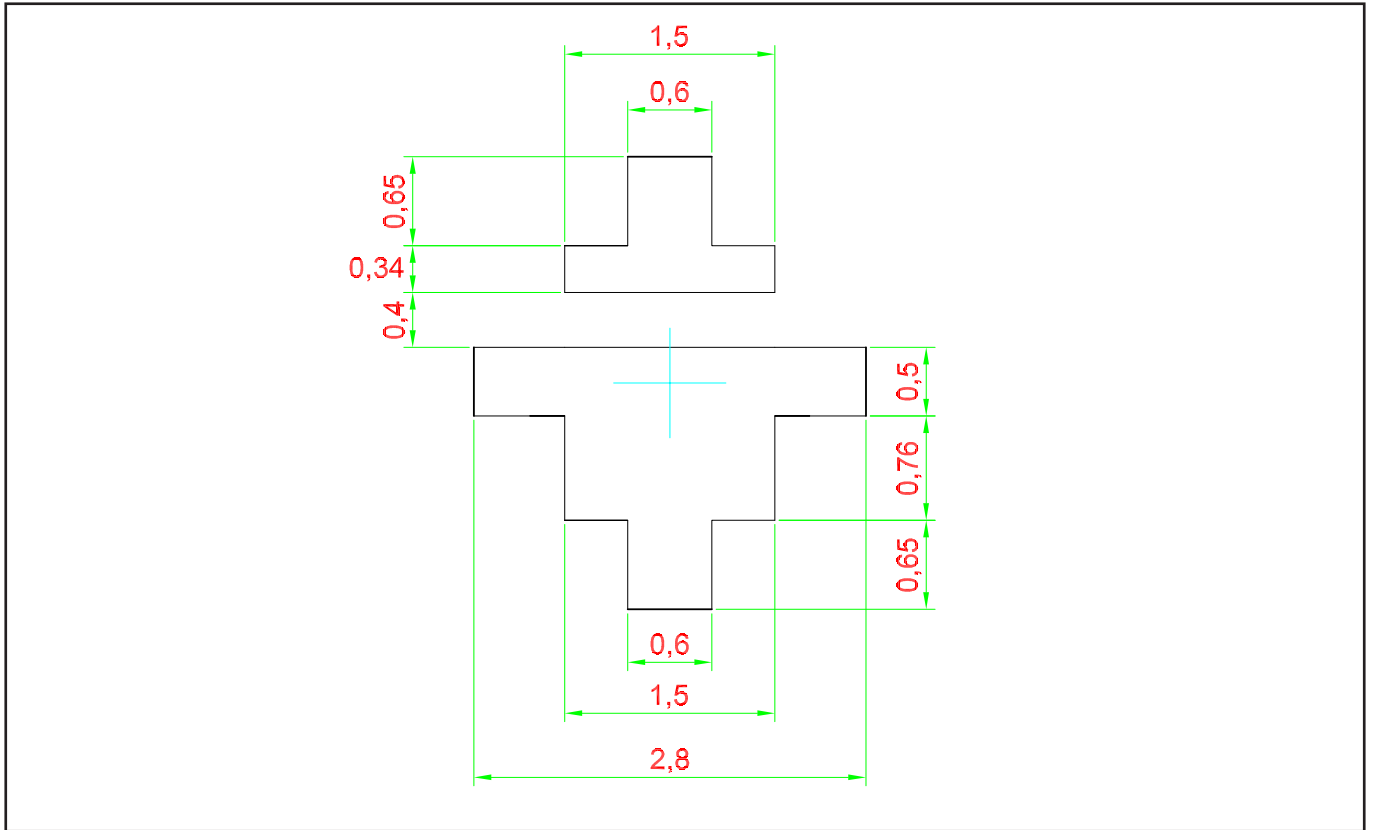

**Recommended Solder Stencil Design**

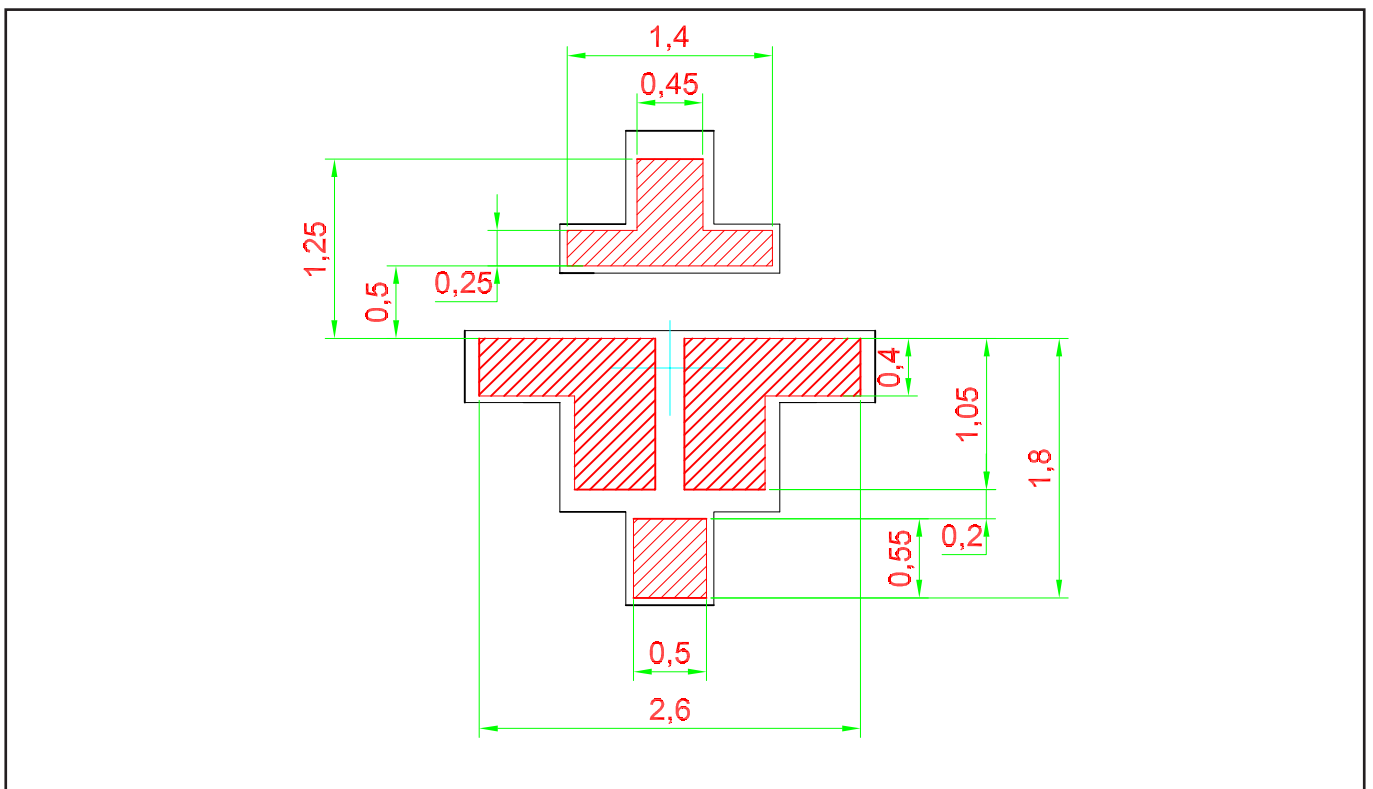



**Taping and orientation**

- Reels come in quantity of 2000 units.
- Reel diameter is 180 mm.

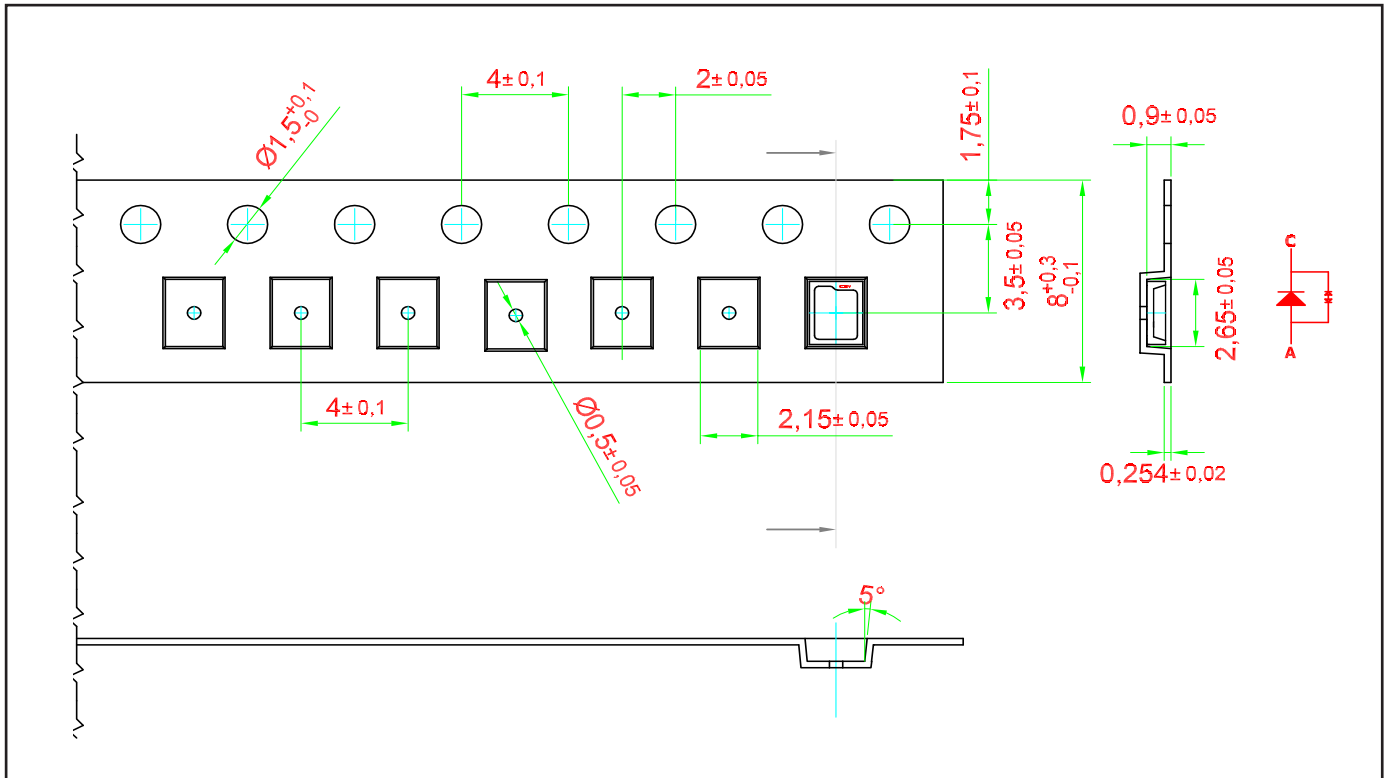

## Packaging Specification

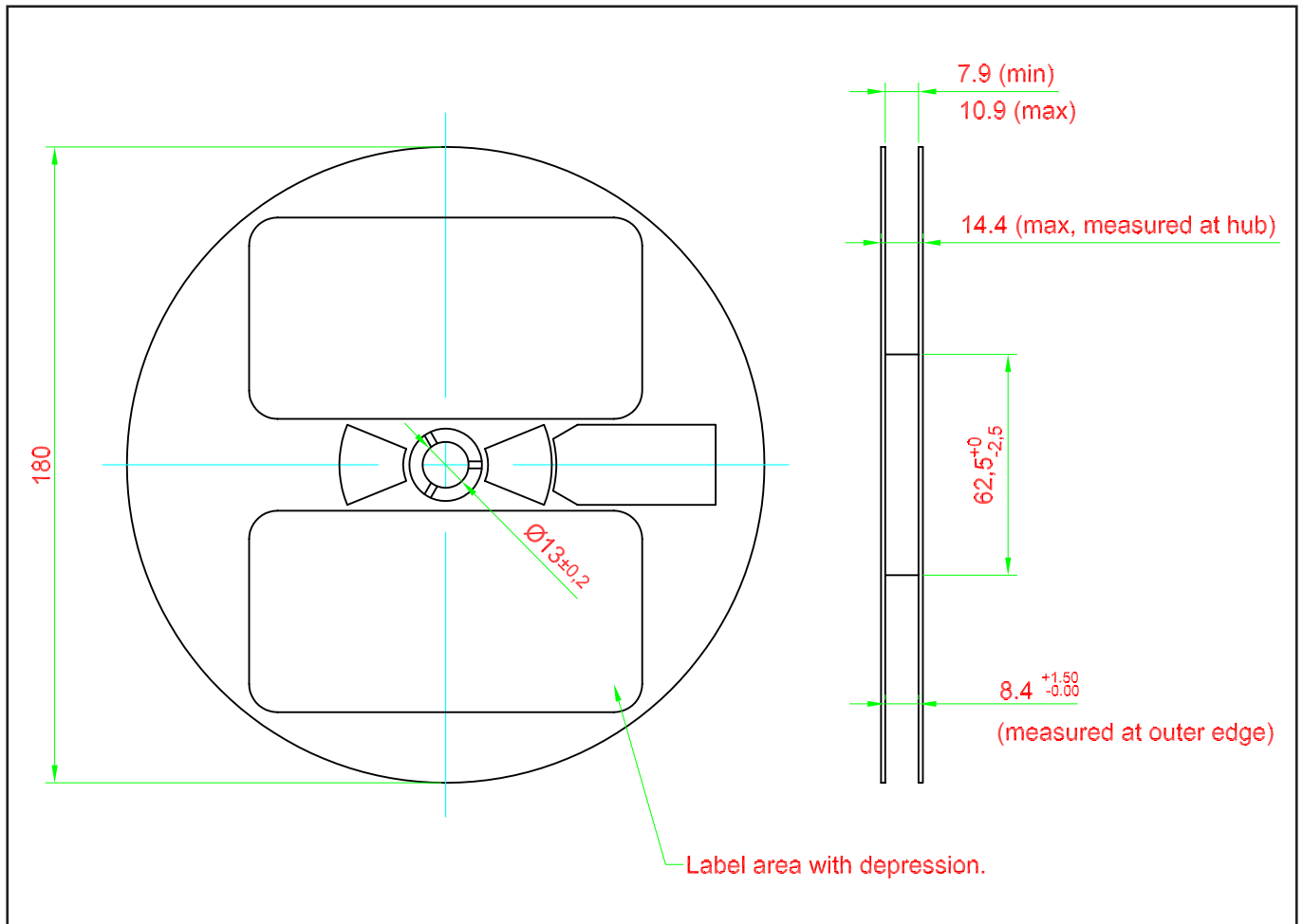

## Packaging Specification

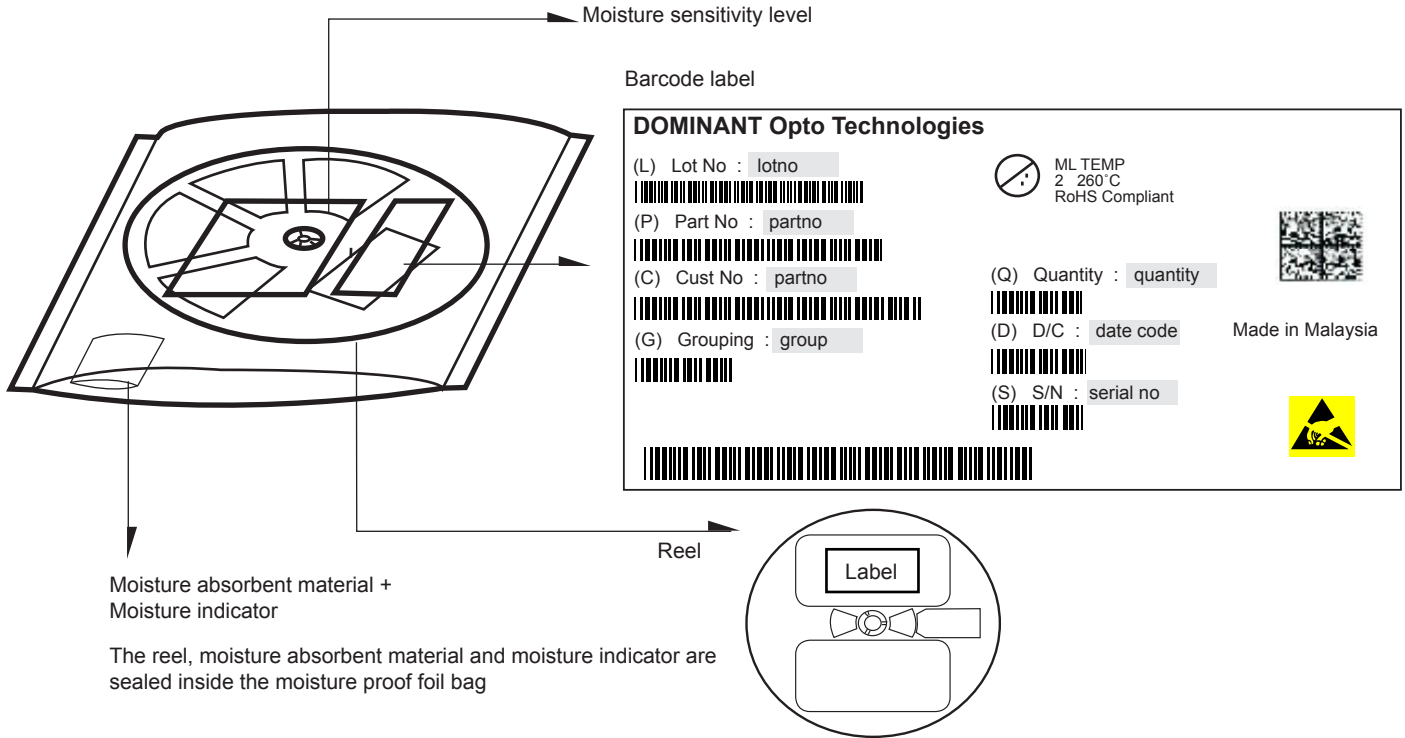

	Average 1pc SpicePlus 2520	1 completed bag (2000pcs)
Weight (gram)	0.011	200 ± 10

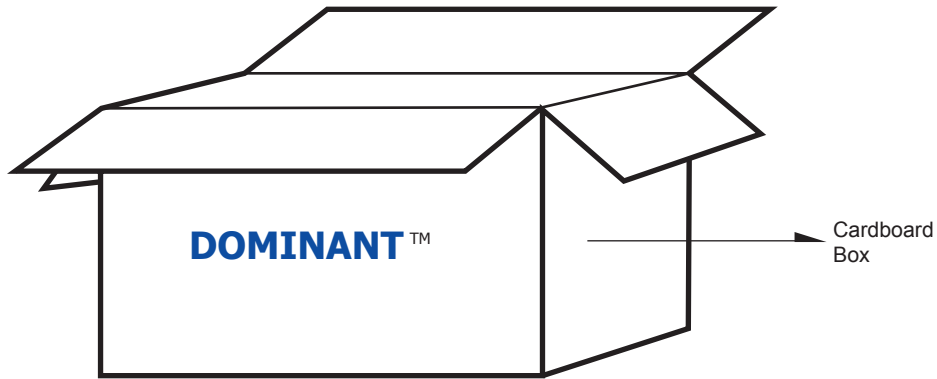

### For SpicePlus 2520

Cardboard Box Size	Dimensions (mm)	Empty Box Weight (kg)	Reel / Box
Super Small	325 x 225 x 190	0.38	9 reels MAX
Small	325 x 225 x 280	0.54	15 reels MAX
Medium	570 x 440 x 230	1.46	60 reels MAX
Large	570 x 440 x 460	1.92	120 reels MAX

## Recommended Pb-free Soldering Profile

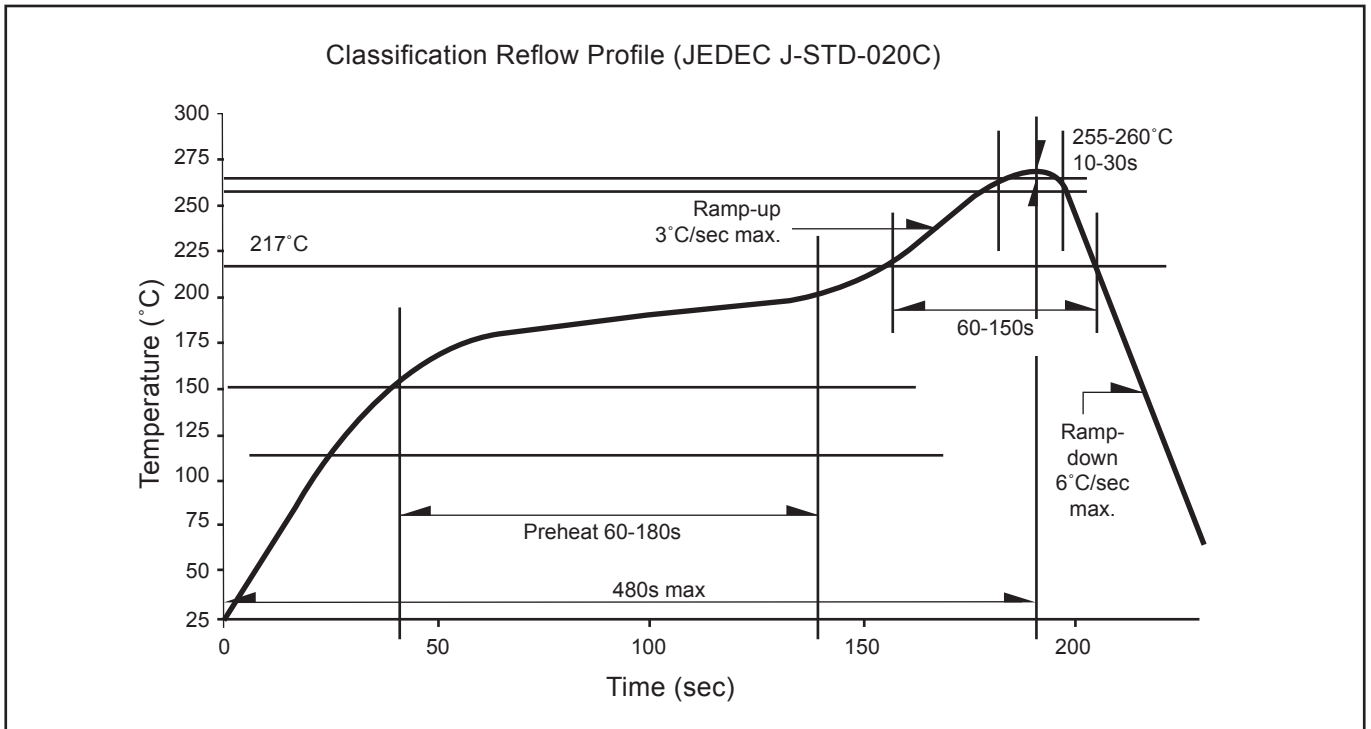

## Appendix

### 1) **Brightness:**

- 1.1 Luminous intensity is measured with an internal reproducibility of  $\pm 8\%$  and an expanded uncertainty of  $\pm 11\%$  (according to GUM with a coverage factor of  $k=3$ ).
- 1.2 Luminous flux is measured with an internal reproducibility of  $\pm 8\%$  and an expanded uncertainty of  $\pm 11\%$  (according to GUM with a coverage factor of  $k=3$ ).
- 1.3 Radiant intensity is measured with an internal reproducibility of  $\pm 8\%$  and an expanded uncertainty of  $\pm 11\%$  (according to GUM with a coverage factor of  $k=3$ ).
- 1.4 Radiant flux is measured with an internal reproducibility of  $\pm 8\%$  and an expanded uncertainty of  $\pm 11\%$  (according to GUM with a coverage factor of  $k=3$ ).

### 2) **Color:**

- 2.1 Chromaticity coordinate groups are measured with an internal reproducibility of  $\pm 0.005$  and an expanded uncertainty of  $\pm 0.01$  (accordingly to GUM with a coverage factor of  $k=3$ ).
- 2.2 DOMINANT wavelength is measured with an internal reproducibility of  $\pm 0.5\text{nm}$  and an expanded uncertainty of  $\pm 1\text{nm}$  (accordingly to GUM with a coverage factor of  $k=3$ ).

### 3) **Voltage:**

- 3.1 Forward Voltage,  $V_f$  is measured with an internal reproducibility of  $\pm 0.05\text{V}$  and an expanded uncertainty of  $\pm 0.1\text{V}$  (accordingly to GUM with a coverage factor of  $k=3$ ).

### 4) **Corrosion Robustness:**

- 4.1 Test conditions:  $40\text{ }^\circ\text{C} / 90\% \text{ rh} / 15 \text{ ppm H}_2\text{S} / 336 \text{ h}$ .  
= Stricter than IEC 60068-2-43 ( $\text{H}_2\text{S}$ ) [ $25\text{ }^\circ\text{C} / 75\% \text{ rh} / 10 \text{ ppm H}_2\text{S} / 21 \text{ days}$ ].

## Revision History

Page	Subjects	Date of Modification
-	Initial Release	05 Jan 2018

**NOTE**

All the information contained in this document is considered to be reliable at the time of publishing. However, DOMINANT Opto Technologies does not assume any liability arising out of the application or use of any product described herein.

DOMINANT Opto Technologies reserves the right to make changes to any products in order to improve reliability, function or design.

DOMINANT Opto Technologies products are not authorized for use as critical components in life support devices or systems without the express written approval from the Managing Director of DOMINANT Opto Technologies.

## About Us

DOMINANT Opto Technologies is a dynamic company that is amongst the world's leading automotive LED manufacturers. With an extensive industry experience and relentless pursuit of innovation, DOMINANT's state-of-art manufacturing and development capabilities have become a trusted and reliable brand across the globe. More information about DOMINANT Opto Technologies, a ISO/TS 16949 and ISO 14001 certified company, can be found under <http://www.dominant-semi.com>.

### **Please contact us for more information:**

DOMINANT Opto Technologies Sdn. Bhd.  
Lot 6, Batu Berendam, FTZ Phase III, 75350 Melaka, Malaysia  
Tel: (606) 283 3566 Fax: (606) 283 0566  
E-mail: [sales@dominant-semi.com](mailto:sales@dominant-semi.com)