

To our customers,

Old Company Name in Catalogs and Other Documents

On April 1st, 2010, NEC Electronics Corporation merged with Renesas Technology Corporation, and Renesas Electronics Corporation took over all the business of both companies. Therefore, although the old company name remains in this document, it is a valid Renesas Electronics document. We appreciate your understanding.

Renesas Electronics website: <http://www.renesas.com>

April 1st, 2010
Renesas Electronics Corporation

Issued by: Renesas Electronics Corporation (<http://www.renesas.com>)

Send any inquiries to <http://www.renesas.com/inquiry>.

Notice

1. All information included in this document is current as of the date this document is issued. Such information, however, is subject to change without any prior notice. Before purchasing or using any Renesas Electronics products listed herein, please confirm the latest product information with a Renesas Electronics sales office. Also, please pay regular and careful attention to additional and different information to be disclosed by Renesas Electronics such as that disclosed through our website.
2. Renesas Electronics does not assume any liability for infringement of patents, copyrights, or other intellectual property rights of third parties by or arising from the use of Renesas Electronics products or technical information described in this document. No license, express, implied or otherwise, is granted hereby under any patents, copyrights or other intellectual property rights of Renesas Electronics or others.
3. You should not alter, modify, copy, or otherwise misappropriate any Renesas Electronics product, whether in whole or in part.
4. Descriptions of circuits, software and other related information in this document are provided only to illustrate the operation of semiconductor products and application examples. You are fully responsible for the incorporation of these circuits, software, and information in the design of your equipment. Renesas Electronics assumes no responsibility for any losses incurred by you or third parties arising from the use of these circuits, software, or information.
5. When exporting the products or technology described in this document, you should comply with the applicable export control laws and regulations and follow the procedures required by such laws and regulations. You should not use Renesas Electronics products or the technology described in this document for any purpose relating to military applications or use by the military, including but not limited to the development of weapons of mass destruction. Renesas Electronics products and technology may not be used for or incorporated into any products or systems whose manufacture, use, or sale is prohibited under any applicable domestic or foreign laws or regulations.
6. Renesas Electronics has used reasonable care in preparing the information included in this document, but Renesas Electronics does not warrant that such information is error free. Renesas Electronics assumes no liability whatsoever for any damages incurred by you resulting from errors in or omissions from the information included herein.
7. Renesas Electronics products are classified according to the following three quality grades: “Standard”, “High Quality”, and “Specific”. The recommended applications for each Renesas Electronics product depends on the product’s quality grade, as indicated below. You must check the quality grade of each Renesas Electronics product before using it in a particular application. You may not use any Renesas Electronics product for any application categorized as “Specific” without the prior written consent of Renesas Electronics. Further, you may not use any Renesas Electronics product for any application for which it is not intended without the prior written consent of Renesas Electronics. Renesas Electronics shall not be in any way liable for any damages or losses incurred by you or third parties arising from the use of any Renesas Electronics product for an application categorized as “Specific” or for which the product is not intended where you have failed to obtain the prior written consent of Renesas Electronics. The quality grade of each Renesas Electronics product is “Standard” unless otherwise expressly specified in a Renesas Electronics data sheets or data books, etc.
 - “Standard”: Computers; office equipment; communications equipment; test and measurement equipment; audio and visual equipment; home electronic appliances; machine tools; personal electronic equipment; and industrial robots.
 - “High Quality”: Transportation equipment (automobiles, trains, ships, etc.); traffic control systems; anti-disaster systems; anti-crime systems; safety equipment; and medical equipment not specifically designed for life support.
 - “Specific”: Aircraft; aerospace equipment; submersible repeaters; nuclear reactor control systems; medical equipment or systems for life support (e.g. artificial life support devices or systems), surgical implantations, or healthcare intervention (e.g. excision, etc.), and any other applications or purposes that pose a direct threat to human life.
8. You should use the Renesas Electronics products described in this document within the range specified by Renesas Electronics, especially with respect to the maximum rating, operating supply voltage range, movement power voltage range, heat radiation characteristics, installation and other product characteristics. Renesas Electronics shall have no liability for malfunctions or damages arising out of the use of Renesas Electronics products beyond such specified ranges.
9. Although Renesas Electronics endeavors to improve the quality and reliability of its products, semiconductor products have specific characteristics such as the occurrence of failure at a certain rate and malfunctions under certain use conditions. Further, Renesas Electronics products are not subject to radiation resistance design. Please be sure to implement safety measures to guard them against the possibility of physical injury, and injury or damage caused by fire in the event of the failure of a Renesas Electronics product, such as safety design for hardware and software including but not limited to redundancy, fire control and malfunction prevention, appropriate treatment for aging degradation or any other appropriate measures. Because the evaluation of microcomputer software alone is very difficult, please evaluate the safety of the final products or system manufactured by you.
10. Please contact a Renesas Electronics sales office for details as to environmental matters such as the environmental compatibility of each Renesas Electronics product. Please use Renesas Electronics products in compliance with all applicable laws and regulations that regulate the inclusion or use of controlled substances, including without limitation, the EU RoHS Directive. Renesas Electronics assumes no liability for damages or losses occurring as a result of your noncompliance with applicable laws and regulations.
11. This document may not be reproduced or duplicated, in any form, in whole or in part, without prior written consent of Renesas Electronics.
12. Please contact a Renesas Electronics sales office if you have any questions regarding the information contained in this document or Renesas Electronics products, or if you have any other inquiries.

(Note 1) “Renesas Electronics” as used in this document means Renesas Electronics Corporation and also includes its majority-owned subsidiaries.

(Note 2) “Renesas Electronics product(s)” means any product developed or manufactured by or for Renesas Electronics.

**5 V, SILICON MMIC
MEDIUM OUTPUT POWER AMPLIFIER**

DESCRIPTION

The μ PC3223TB is a silicon monolithic IC designed as IF amplifier for DBS tuners. This IC is manufactured using our 30 GHz f_{max} UHS0 (Ultra High Speed Process) silicon bipolar process.

FEATURES

- Wideband response : $f_u = 3.2$ GHz TYP. @ 3 dB bandwidth
- Medium output power: $P_{O(sat)} = +12.0$ dBm @ $f = 1.0$ GHz
: $P_{O(sat)} = +9.0$ dBm @ $f = 2.2$ GHz
- High linearity : $P_{O(1\text{ dB})} = +6.5$ dBm @ $f = 1.0$ GHz
: $P_{O(1\text{ dB})} = +5.0$ dBm @ $f = 2.2$ GHz
- Power gain : $G_P = 23.0$ dB TYP. @ $f = 1.0$ GHz
: $G_P = 23.0$ dB TYP. @ $f = 2.2$ GHz
- Supply voltage : $V_{CC} = 4.5$ to 5.5 V
- Port impedance : input/output 50Ω

APPLICATION

- IF amplifiers in DBS converters etc.

ORDERING INFORMATION

| Part Number | Package | Marking | Supplying Form |
|-------------------|----------------------|---------|--|
| μ PC3223TB-E3 | 6-pin super minimold | C3J | <ul style="list-style-type: none"> • Embossed tape 8 mm wide • 1, 2, 3 pins face the perforation side of tape • Qty 3 kpcs/reel |

Remark To order evaluation samples, contact your nearby sales office.

Part number for sample order: μ PC3223TB

Caution Observe precautions when handling because these devices are sensitive to electrostatic discharge.

The information in this document is subject to change without notice. Before using this document, please confirm that this is the latest version.
Not all devices/types available in every country. Please check with local NEC Compound Semiconductor Devices representative for availability and additional information.

PIN CONNECTIONS

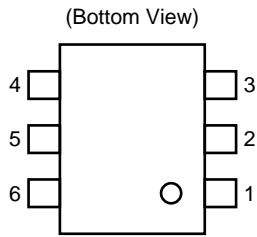
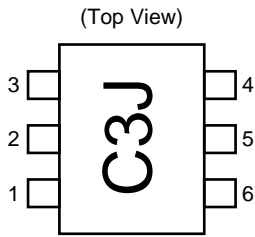

| Pin No. | Pin Name |
|---------|-----------------|
| 1 | INPUT |
| 2 | GND |
| 3 | GND |
| 4 | OUTPUT |
| 5 | GND |
| 6 | V _{CC} |

PRODUCT LINE-UP OF 5 V-BIAS SILICON MMIC MEDIUM OUTPUT AMPLIFIER
 (T_A = +25°C, f = 1 GHz, V_{CC} = V_{out} = 5.0 V, Z_s = Z_L = 50 Ω)

| Part No. | f _u (GHz) | P _{O(sat)} (dBm) | G _P (dB) | NF (dB) | I _{CC} (mA) | Package | Marking |
|----------------|-------------------------|------------------------------|------------------------|------------|-------------------------|----------------------|---------|
| μ PC2708TB | 2.9 | +10.0 | 15 | 6.5 | 26 | 6-pin super minimold | C1D |
| μ PC2709TB | 2.3 | +11.5 | 23 | 5.0 | 25 | | C1E |
| μ PC2710TB | 1.0 | +13.5 | 33 | 3.5 | 22 | | C1F |
| μ PC2776TB | 2.7 | +8.5 | 23 | 6.0 | 25 | | C2L |
| μ PC3223TB | 3.2 | +12.0 | 23 | 4.5 | 19 | | C3J |

Remark Typical performance. Please refer to **ELECTRICAL CHARACTERISTICS** in detail.

PIN EXPLANATIONS

| PIN No. | Pin Name | Applied Voltage (V) | Pin Voltage (V) <small>Note</small> | Function and Applications |
|-------------|-----------------|--|--|---|
| 1 | INPUT | – | 0.96 | Signal input pin. A internal matching circuit, configured with resistors, enables 50 Ω connection over a wide band. A multi-feedback circuits is designed to cancel the deviations of h _{FE} and resistance. This pin must be coupled to signal source with capacitor for DC cut. |
| 4 | OUTPUT | Voltage as same as V _{CC} through external inductor | – | Signal output pin. The inductor must be attached between V _{CC} and output pins to supply current to the internal output transistors. |
| 6 | V _{CC} | 4.5 to 5.5 | – | Power supply pin. Witch biases the internal input transistor. This pin should be externally equipped with bypass capacitor to minimize its impedance. |
| 2 3 5 | GND | 0 | – | Ground pin. This pin should be connected to system ground with minimum inductance. Ground pattern on the board should be formed as wide as possible. All the ground pins must be connected together with wide ground pattern to decrease impedance difference. |

Note Pin Voltage is measured at V_{CC} = 5.0 V

ABSOLUTE MAXIMUM RATINGS

| Parameter | Symbol | Conditions | Ratings | Unit |
|-------------------------------|-----------|---|-------------|------------------|
| Supply Voltage | V_{CC} | $T_A = +25^\circ\text{C}$, Pin 4 and 6 | 6.0 | V |
| Total Circuit Current | I_{CC} | $T_A = +25^\circ\text{C}$ | 40 | mA |
| Power Dissipation | P_D | $T_A = +85^\circ\text{C}$ Note | 270 | mW |
| Operating Ambient Temperature | T_A | | -40 to +85 | $^\circ\text{C}$ |
| Storage Temperature | T_{stg} | | -55 to +150 | $^\circ\text{C}$ |
| Input Power | P_{in} | $T_A = +25^\circ\text{C}$ | +10 | dBm |

Note Mounted on double-sided copper-clad 50 × 50 × 1.6 mm epoxy glass PWB

RECOMMENDED OPERATING RANGE

| Parameter | Symbol | Conditions | MIN. | TYP. | MAX. | Unit |
|-------------------------------|----------|--|------|------|------|------------------|
| Supply Voltage | V_{CC} | The same voltage should be applied to pin 4 and 6. | 4.5 | 5.0 | 5.5 | V |
| Operating Ambient Temperature | T_A | | -40 | +25 | +85 | $^\circ\text{C}$ |

ELECTRICAL CHARACTERISTICS ($T_A = +25^\circ\text{C}$, $V_{CC} = V_{out} = 5.0\text{ V}$, $Z_s = Z_L = 50\ \Omega$)

| Parameter | Symbol | Test Conditions | MIN. | TYP. | MAX. | Unit |
|------------------------------------|----------------------|---|------|-----------|------|------|
| Circuit Current | I_{CC} | No input signal | 15.0 | 19.0 | 24.0 | mA |
| Power Gain | G_P | $f = 1.0\text{ GHz}$, $P_{in} = -30\text{ dBm}$ | 20.5 | 23.0 | 25.5 | dB |
| | | $f = 2.2\text{ GHz}$, $P_{in} = -30\text{ dBm}$ | 20.0 | 23.0 | 26.0 | |
| Saturated Output Power | $P_{O(sat)}$ | $f = 1.0\text{ GHz}$, $P_{in} = -5\text{ dBm}$ | +9.0 | +12.0 | - | dBm |
| | | $f = 2.2\text{ GHz}$, $P_{in} = -5\text{ dBm}$ | +6.0 | +9.0 | - | |
| Gain 1 dB Compression Output Power | $P_{O(1\text{ dB})}$ | $f = 1.0\text{ GHz}$ | +4.5 | +6.5 | - | dBm |
| | | $f = 2.2\text{ GHz}$ | +3.0 | +5.0 | - | |
| Noise Figure | NF | $f = 1.0\text{ GHz}$ | - | 4.5 | 6.0 | dB |
| | | $f = 2.2\text{ GHz}$ | - | 4.0 | 5.5 | |
| Upper Limit Operating Frequency | f_u | 3 dB down below flat gain at $f = 0.1\text{ GHz}$ | 2.8 | 3.2 | - | GHz |
| Isolation | ISL | $f = 1.0\text{ GHz}$, $P_{in} = -30\text{ dBm}$ | 28.0 | 33.0 | - | dB |
| | | $f = 2.2\text{ GHz}$, $P_{in} = -30\text{ dBm}$ | 28.0 | 33.0 | - | |
| Input Return Loss | RL_{in} | $f = 1.0\text{ GHz}$, $P_{in} = -30\text{ dBm}$ | 9.0 | 12.0 | - | dB |
| | | $f = 2.2\text{ GHz}$, $P_{in} = -30\text{ dBm}$ | 12.0 | 17.5 | - | |
| Output Return Loss | RL_{out} | $f = 1.0\text{ GHz}$, $P_{in} = -30\text{ dBm}$ | 9.0 | 12.0 | - | dB |
| | | $f = 2.2\text{ GHz}$, $P_{in} = -30\text{ dBm}$ | 9.0 | 12.0 | - | |
| Gain Flatness | ΔG_P | $f = 0.1\text{ to }2.2\text{ GHz}$ | - | ± 0.9 | - | dB |

OTHER CHARACTERISTICS, FOR REFERENCE PURPOSES ONLY
(T_A = +25°C, V_{CC} = V_{out} = 5.0 V, Z_S = Z_L = 50 Ω)

| Parameter | Symbol | Test Conditions | Reference Value | Unit |
|------------------------|------------------|-----------------|-----------------|------|
| Output Intercept Point | OIP ₃ | f = 1.0 GHz | +17.8 | dBm |
| | | f = 2.2 GHz | +14.8 | |

TEST CIRCUIT

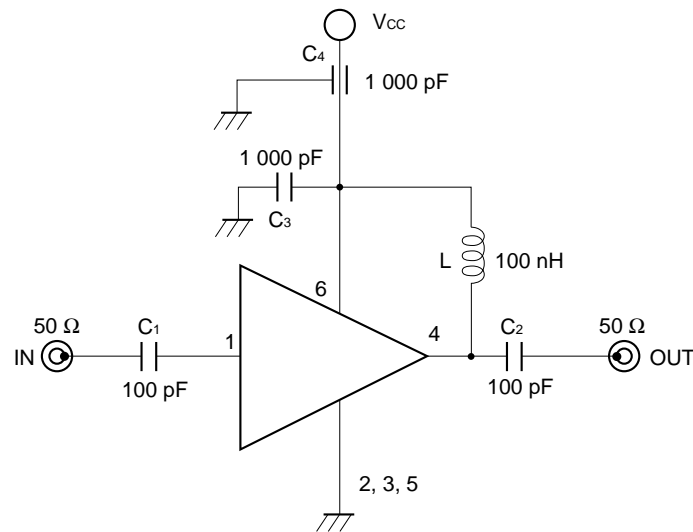

The application circuits and their parameters are for reference only and are not intended for use in actual design-ins.

COMPONENTS OF TEST CIRCUIT FOR MEASURING ELECTRICAL CHARACTERISTICS

| | Type | Value |
|---------------------------------|------------------------|----------|
| C ₁ , C ₂ | Chip Capacitor | 100 pF |
| C ₃ | Chip Capacitor | 1 000 pF |
| C ₄ | Feed-through Capacitor | 1 000 pF |
| L | Chip Inductor | 100 nH |

INDUCTOR FOR THE OUTPUT PIN

The internal output transistor of this IC consumes 20 mA, to output medium power. To supply current for output transistor, connect an inductor between the Vcc pin (pin 6) and output pin (pin 4). Select large value inductance, as listed above.

The inductor has both DC and AC effects. In terms of DC, the inductor biases the output transistor with minimum voltage drop to output enable high level. In terms of AC, the inductor makes output-port impedance higher to get enough gain. In this case, large inductance and Q is suitable.

CAPACITORS FOR THE Vcc, INPUT AND OUTPUT PINS

Capacitors of 1000 pF are recommendable as the bypass capacitor for the Vcc pin and the coupling capacitors for the input and output pins.

The bypass capacitor connected to the Vcc pin is used to minimize ground impedance of Vcc pin. So, stable bias can be supplied against Vcc fluctuation.

The coupling capacitors, connected to the input and output pins, are used to cut the DC and minimize RF serial impedance. Their capacitances are therefore selected as lower impedance against a 50 Ω load. The capacitors thus perform as high pass filters, suppressing low frequencies to DC.

To obtain a flat gain from 100 MHz upwards, 1 000 pF capacitors are used in the test circuit. In the case of under 10 MHz operation, increase the value of coupling capacitor such as 10 000 pF. Because the coupling capacitors are determined by equation, $C = 1/(2 \pi Rfc)$.

ILLUSTRATION OF THE TEST CIRCUIT ASSEMBLED ON EVALUATION BOARD

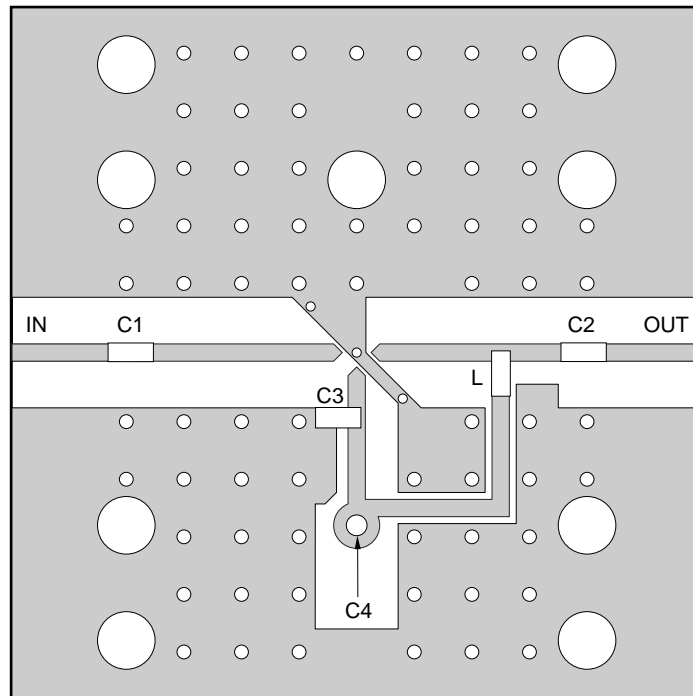

COMPONENT LIST

| | Value |
|---------------------------------|----------|
| C ₁ , C ₂ | 100 pF |
| C ₃ , C ₄ | 1 000 pF |
| L | 100 nH |

Notes

1. 30 × 30 × 0.4 mm double sided copper clad polyimide board.
2. Back side: GND pattern
3. Solder plated on pattern
4. ○: Through holes

TYPICAL CHARACTERISTICS ($T_A = +25^\circ\text{C}$, unless otherwise specified)

CIRCUIT CURRENT vs. SUPPLY VOLTAGE

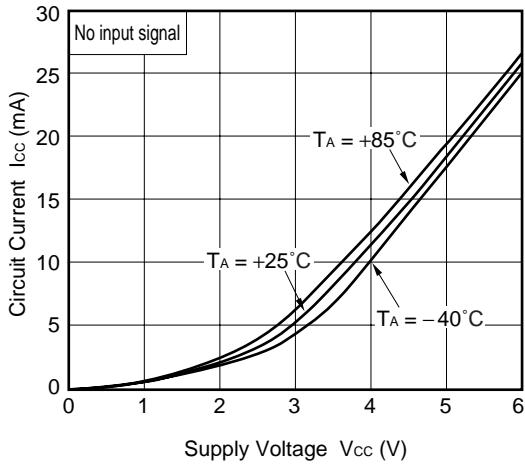

CIRCUIT CURRENT vs. OPERATING AMBIENT TEMPERATURE

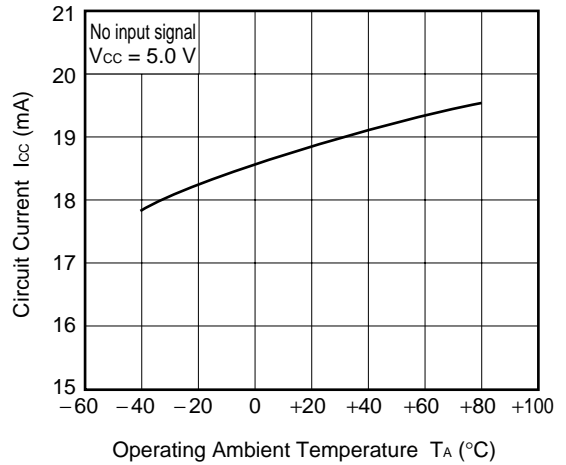

POWER GAIN vs. FREQUENCY

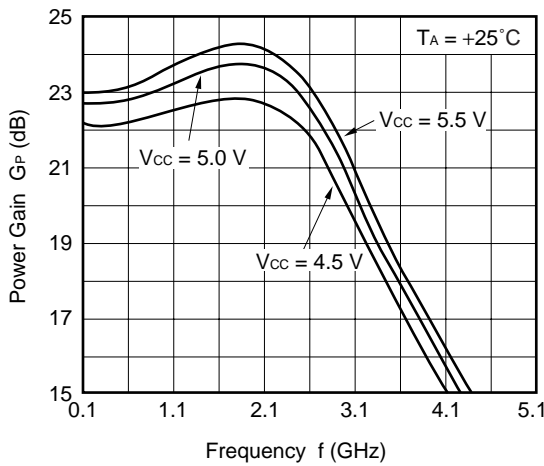

INPUT RETURN LOSS vs. FREQUENCY

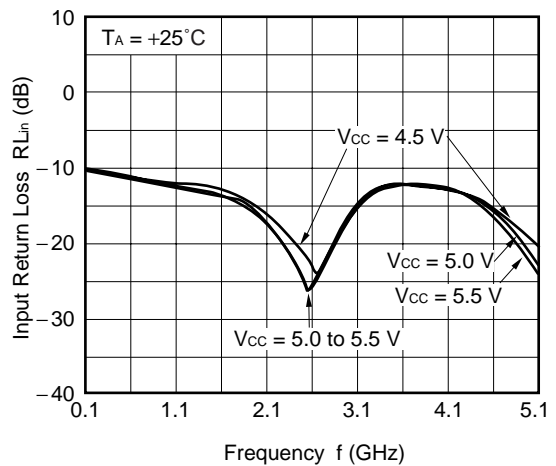

ISOLATION vs. FREQUENCY

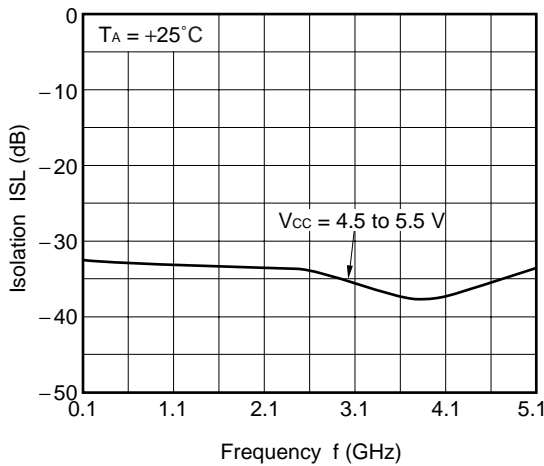

OUTPUT RETURN LOSS vs. FREQUENCY

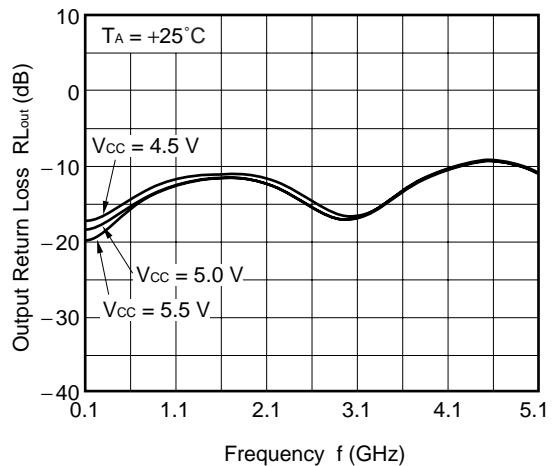

Remark The graphs indicate nominal characteristics.

POWER GAIN vs. FREQUENCY

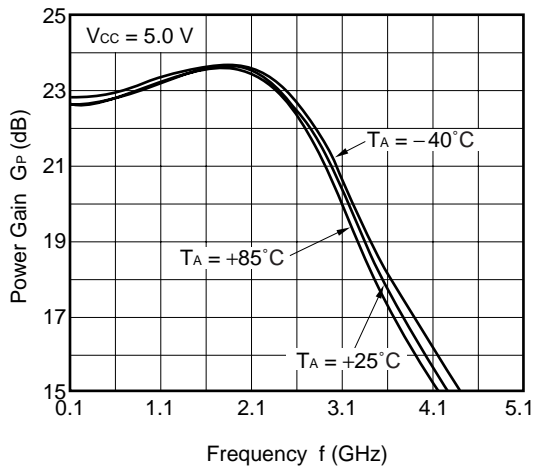

INPUT RETURN LOSS vs. FREQUENCY

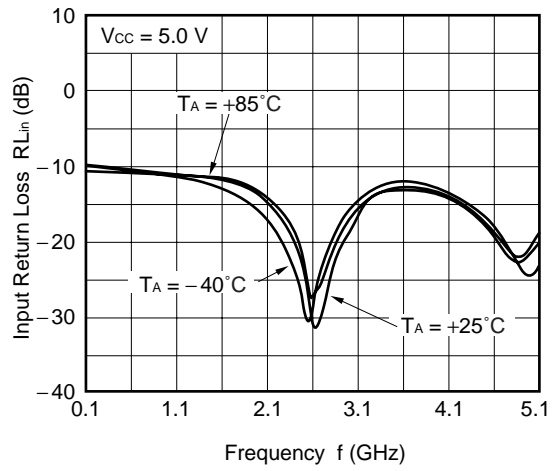

ISOLATION vs. FREQUENCY

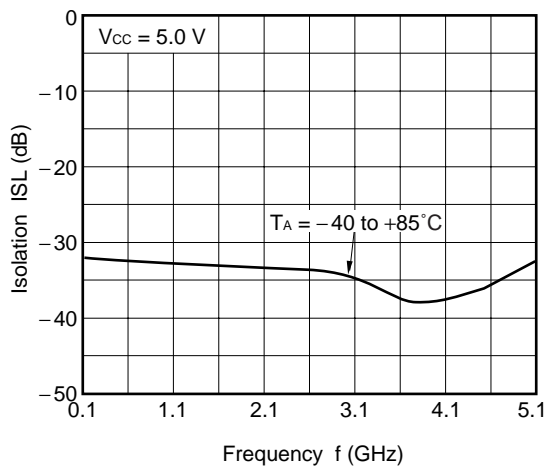

OUTPUT RETURN LOSS vs. FREQUENCY

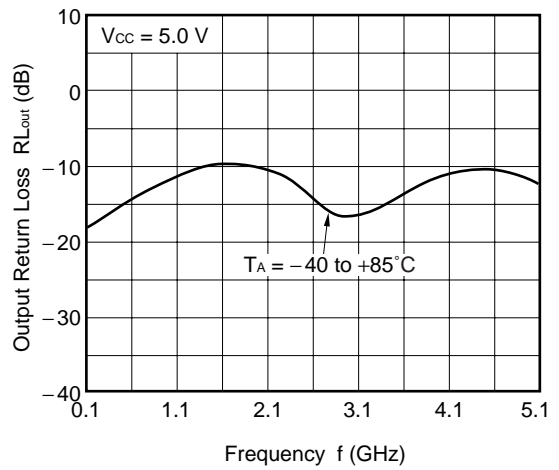

Remark The graphs indicate nominal characteristics.

OUTPUT POWER vs. INPUT POWER

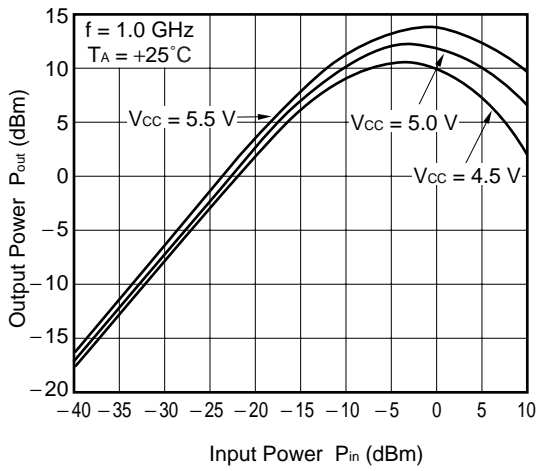

OUTPUT POWER vs. INPUT POWER

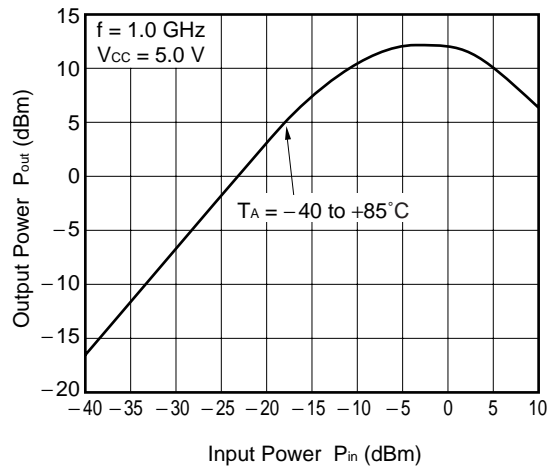

OUTPUT POWER vs. INPUT POWER

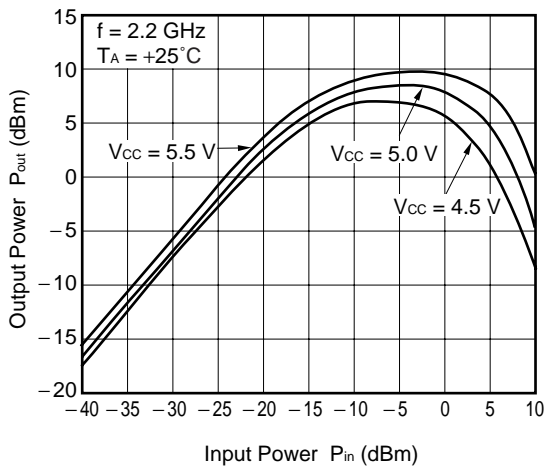

OUTPUT POWER vs. INPUT POWER

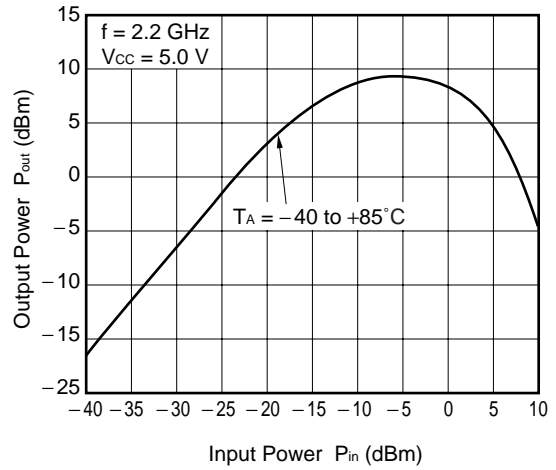

OUTPUT POWER (2 tones), IM3 vs. INPUT POWER

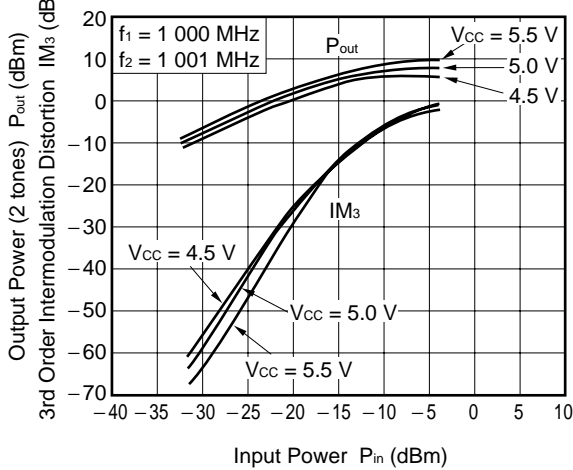

OUTPUT POWER (2 tones), IM3 vs. INPUT POWER

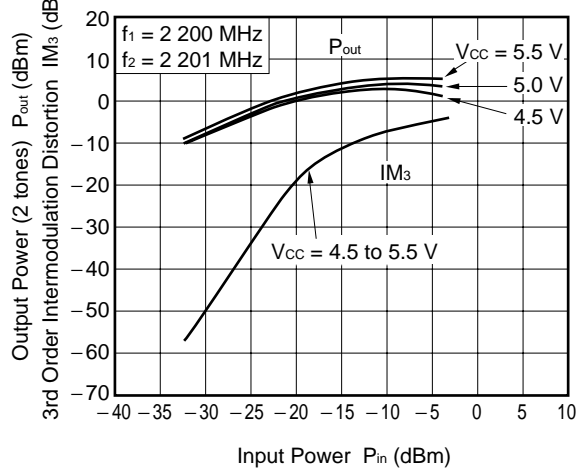

Remark The graphs indicate nominal characteristics.

S-PARAMETERS ($T_A = +25^\circ\text{C}$, $V_{CC} = V_{out} = 5.0\text{ V}$)

S₁₁-FREQUENCY

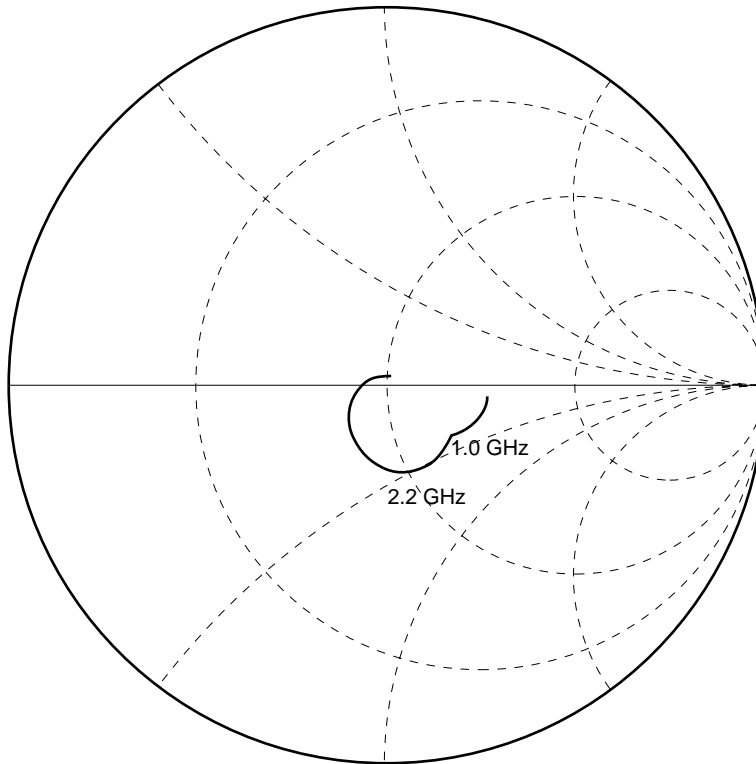

S₂₂-FREQUENCY

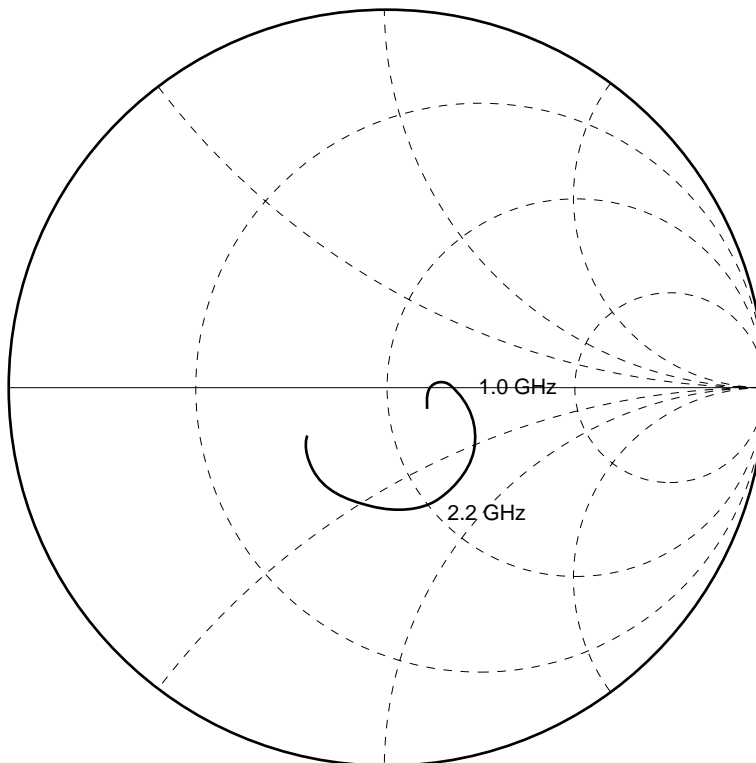

PACKAGE DIMENSIONS

6-PIN SUPER MINIMOLD (UNIT: mm)

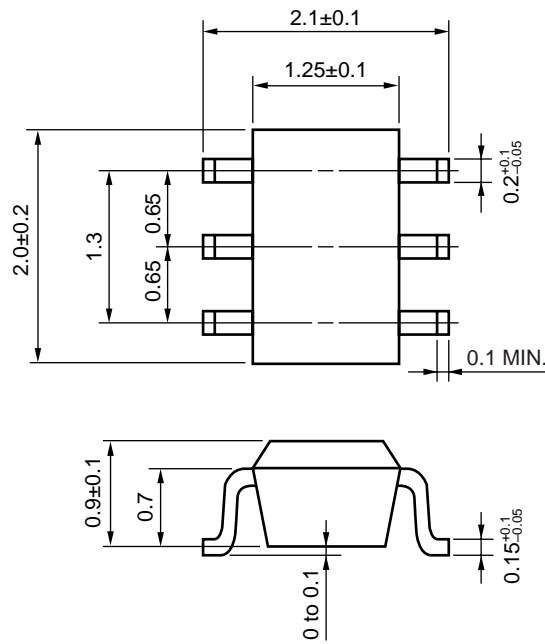

NOTES ON CORRECT USE

- (1) Observe precautions for handling because of electro-static sensitive devices.
- (2) Form a ground pattern as widely as possible to minimize ground impedance (to prevent undesired oscillation).
All the ground pins must be connected together with wide ground pattern to decrease impedance difference.
- (3) The bypass capacitor should be attached to Vcc line.
- (4) The inductor must be attached between Vcc and output pins. The inductance value should be determined in accordance with desired frequency.
- (5) The DC cut capacitor must be each attached to input and output pin.

RECOMMENDED SOLDERING CONDITIONS

This product should be soldered and mounted under the following recommended conditions. For soldering methods and conditions other than those recommended below, contact your nearby sales office.

| Soldering Method | Soldering Conditions | Condition Symbol |
|------------------|---|------------------|
| Infrared Reflow | Peak temperature (package surface temperature) : 260°C or below Time at peak temperature : 10 seconds or less Time at temperature of 220°C or higher : 60 seconds or less Preheating time at 120 to 180°C : 120±30 seconds Maximum number of reflow processes : 3 times Maximum chlorine content of rosin flux (% mass) : 0.2%(Wt.) or below | IR260 |
| Wave Soldering | Peak temperature (molten solder temperature) : 260°C or below Time at peak temperature : 10 seconds or less Preheating temperature (package surface temperature) : 120°C or below Maximum number of flow processes : 1 time Maximum chlorine content of rosin flux (% mass) : 0.2%(Wt.) or below | WS260 |
| Partial Heating | Peak temperature (pin temperature) : 350°C or below Soldering time (per side of device) : 3 seconds or less Maximum chlorine content of rosin flux (% mass) : 0.2%(Wt.) or below | HS350 |

Caution Do not use different soldering methods together (except for partial heating).

- **The information in this document is current as of May, 2004. The information is subject to change without notice. For actual design-in, refer to the latest publications of NEC's data sheets or data books, etc., for the most up-to-date specifications of NEC semiconductor products. Not all products and/or types are available in every country. Please check with an NEC sales representative for availability and additional information.**
 - No part of this document may be copied or reproduced in any form or by any means without prior written consent of NEC. NEC assumes no responsibility for any errors that may appear in this document.
 - NEC does not assume any liability for infringement of patents, copyrights or other intellectual property rights of third parties by or arising from the use of NEC semiconductor products listed in this document or any other liability arising from the use of such products. No license, express, implied or otherwise, is granted under any patents, copyrights or other intellectual property rights of NEC or others.
 - Descriptions of circuits, software and other related information in this document are provided for illustrative purposes in semiconductor product operation and application examples. The incorporation of these circuits, software and information in the design of customer's equipment shall be done under the full responsibility of customer. NEC assumes no responsibility for any losses incurred by customers or third parties arising from the use of these circuits, software and information.
 - While NEC endeavours to enhance the quality, reliability and safety of NEC semiconductor products, customers agree and acknowledge that the possibility of defects thereof cannot be eliminated entirely. To minimize risks of damage to property or injury (including death) to persons arising from defects in NEC semiconductor products, customers must incorporate sufficient safety measures in their design, such as redundancy, fire-containment, and anti-failure features.
 - NEC semiconductor products are classified into the following three quality grades:
 "Standard", "Special" and "Specific". The "Specific" quality grade applies only to semiconductor products developed based on a customer-designated "quality assurance program" for a specific application. The recommended applications of a semiconductor product depend on its quality grade, as indicated below. Customers must check the quality grade of each semiconductor product before using it in a particular application.
 "Standard": Computers, office equipment, communications equipment, test and measurement equipment, audio and visual equipment, home electronic appliances, machine tools, personal electronic equipment and industrial robots
 "Special": Transportation equipment (automobiles, trains, ships, etc.), traffic control systems, anti-disaster systems, anti-crime systems, safety equipment and medical equipment (not specifically designed for life support)
 "Specific": Aircraft, aerospace equipment, submersible repeaters, nuclear reactor control systems, life support systems and medical equipment for life support, etc.
- The quality grade of NEC semiconductor products is "Standard" unless otherwise expressly specified in NEC's data sheets or data books, etc. If customers wish to use NEC semiconductor products in applications not intended by NEC, they must contact an NEC sales representative in advance to determine NEC's willingness to support a given application.
- (Note)
- (1) "NEC" as used in this statement means NEC Corporation, NEC Compound Semiconductor Devices, Ltd. and also includes its majority-owned subsidiaries.
 - (2) "NEC semiconductor products" means any semiconductor product developed or manufactured by or for NEC (as defined above).

M8E 00.4-0110

► For further information, please contact

NEC Compound Semiconductor Devices, Ltd. <http://www.ncsd.necel.com/>

E-mail: salesinfo@ml.ncsd.necel.com (sales and general)

techinfo@ml.ncsd.necel.com (technical)

5th Sales Group, Sales Division TEL: +81-44-435-1588 FAX: +81-44-435-1579

NEC Compound Semiconductor Devices Hong Kong Limited

E-mail: ncsd-hk@elhk.nec.com.hk (sales, technical and general)

Hong Kong Head Office TEL: +852-3107-7303 FAX: +852-3107-7309

Taipei Branch Office TEL: +886-2-8712-0478 FAX: +886-2-2545-3859

Korea Branch Office TEL: +82-2-558-2120 FAX: +82-2-558-5209

NEC Electronics (Europe) GmbH <http://www.ee.nec.de/>

TEL: +49-211-6503-0 FAX: +49-211-6503-1327

California Eastern Laboratories, Inc. <http://www.cel.com/>

TEL: +1-408-988-3500 FAX: +1-408-988-0279