

## General Description

The QPL1002 is a wideband cascode low noise amplifier fabricated on Qorvo's 0.25um GaN on SiC production process. This cascode LNA is robust to 5W of input power with 17dB typical gain and 1.2dB noise figure from 0.03 GHz to 3.0 GHz. The QPL1002 is ideal for wideband communication applications across defense and commercial markets.

The QPL1002 is housed in a low-cost 16 lead 3x3 plastic overmolded QFN package. It is fully matched to 50 ohms on both RF ports eliminating the need for impedance matching typical of LNAs in this band. DC blocks and bias chokes are required given the low frequency nature of this amplifier.

Lead-free and RoHS compliant.

Evaluation boards are available upon request.

## Product Features

- Frequency Range: 0.03 – 3 GHz
- Noise Figure: 1.2 dB
- Small Signal Gain: 17 dB
- P1dB: 23 dBm
- Output TOI: 30 dBm (@Pout = 18 dBm / tone)
- High Input Power Survivability: 37 dBm
- Bias: VD = 12 V, IDQ = 50 mA, VG = -2.5 V, VC = 2V
- Plastic 3x3 -16L QFN Overmold Package
- Package Dimensions: 3.0 x 3.0 x 0.85 mm

*Performance is typical across frequency. Please reference electrical specification table and data plots for more details.*

## Applications

- Commercial and Military Radar
- Radio Communications
- Electronic Warfare

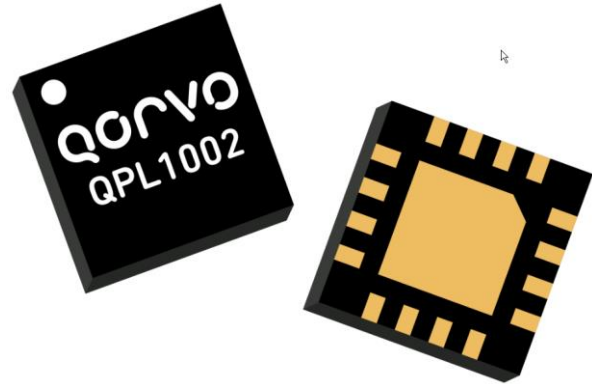

## Functional Block Diagram

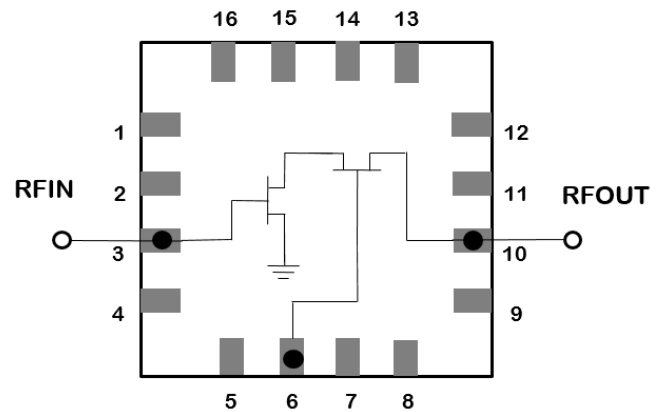

## Pad Configuration

Pad No.	Label
Slug	GND
3	RF Input
6	VC
10	RF Output
1, 2, 4, 5, 7, 8, 9	N/C
11 - 16	N/C

## Ordering Information

Part No.	ECCN	Description
QPL1002	EAR99	0.03 – 3.0 GHz Low Noise Amplifier
QPL1002EVB	EAR99	QPL1002 Low Noise Amplifier EVB

## Absolute Maximum Ratings

Parameter	Value
Drain Voltage (VD)	20.0 V
Drain Current (IDQ)	300 mA
Gate Voltage Range (VG)	0 to -5 V
Gate Current (IG)	20 mA
Control Voltage (VC)	-5V to VD
Control Current (IC)	20 mA
RF Input Power (50 Ω, 85 °C)	37 dBm
Channel Temperature, T <sub>CH</sub>	275 °C
Mounting Temperature (30 seconds)	260 °C
Storage Temperature	-55 to 150 °C

Operation of this device outside the parameter ranges given above may cause permanent damage. These are stress ratings only, and functional operation of the device at these conditions is not implied.

## Recommended Operating Conditions

Parameter	Value
Drain Voltage	12 V
Drain Current (quiescent, IDQ)	50 mA
Gate Voltage (typical)	-2.5 V
Control Voltage (typical)	+2 V
Operating Temperature Range	-40 to 85 °C

Electrical specifications are measured at specified test conditions. Specifications are not guaranteed over all recommended operating conditions.

## Electrical Specifications

Test conditions, unless otherwise noted: VD = 12 V, VC = +2V, IDQ = 50 mA, 25 °C. Data de-embedded to device reference plane

Parameter	Min	Typical	Max	Units
Frequency	0.03		3	GHz
Small Signal Gain		17		dB
Noise Figure		1.2		dB
1-dB Compression Point		23		dBm
Input Return Loss		12		dB
Output Return Loss		11		dB
Robustness (@ 50 Ohm, 85C)		37		dBm
Output TOI (@Pout=18 dBm/tone, 10 MHz tone spacing)		30		dBm
Gain Temperature Coefficient		-0.017		dB/°C
Recommended Drain Voltage		12	15	V

## Performance Plots – Small Signal

Test Conditions unless otherwise stated: VD = 12V, VC = +2V, IDQ = 50mA, 25C  
Data de-embedded to device reference plane

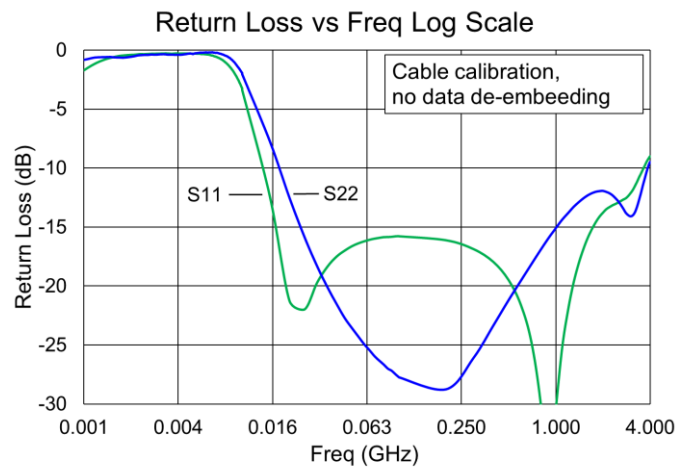
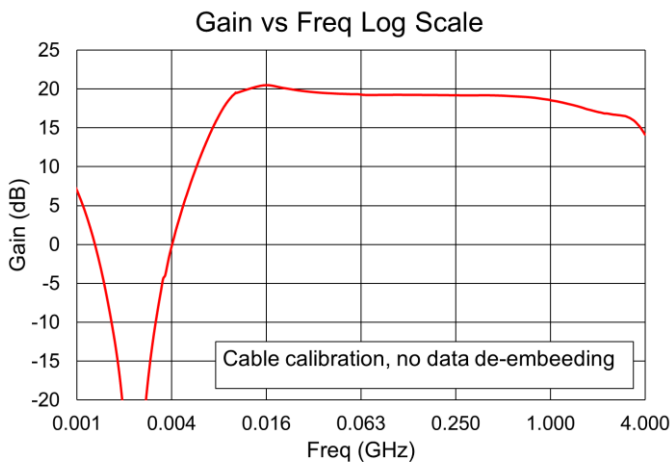
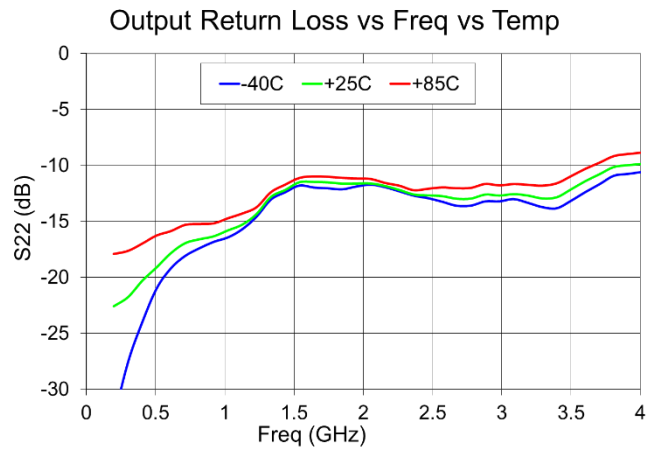
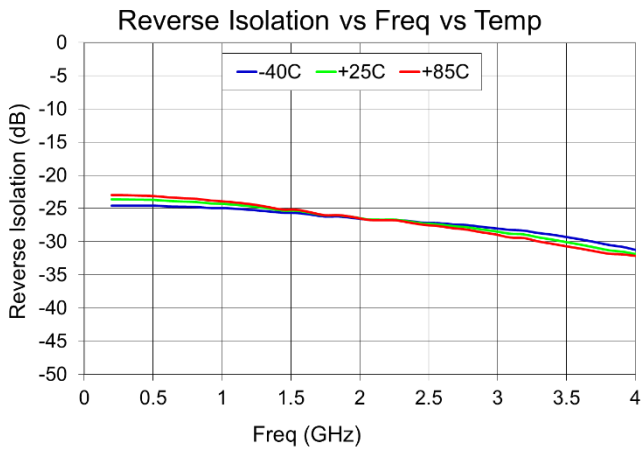
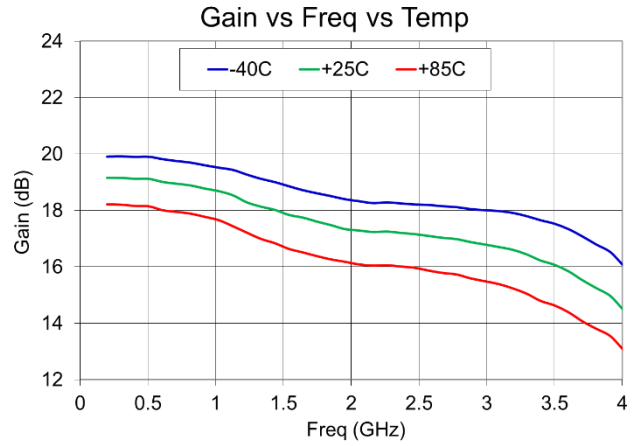
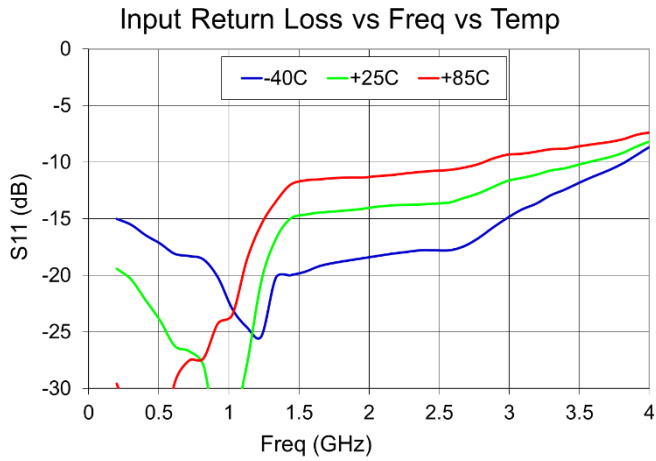

## Performance Plots – Small Signal

Test Conditions unless otherwise stated:  $V_D = 12V$ ,  $V_C = +2V$ ,  $I_{DQ} = 50mA$ ,  $25C$   
Data de-embedded to device reference plane

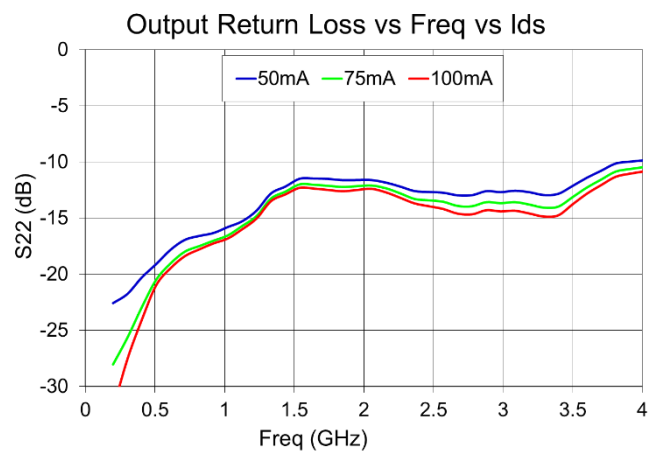
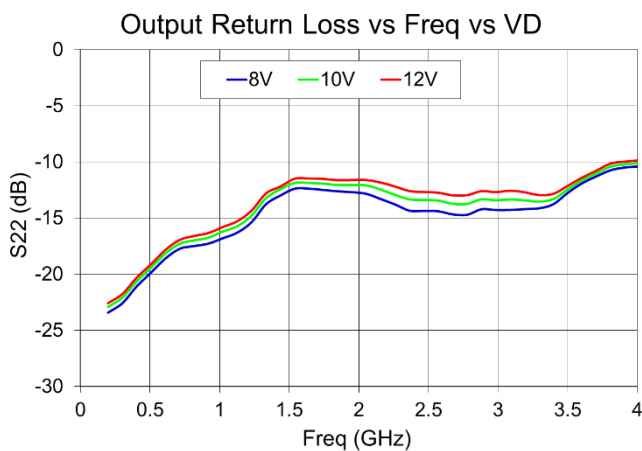
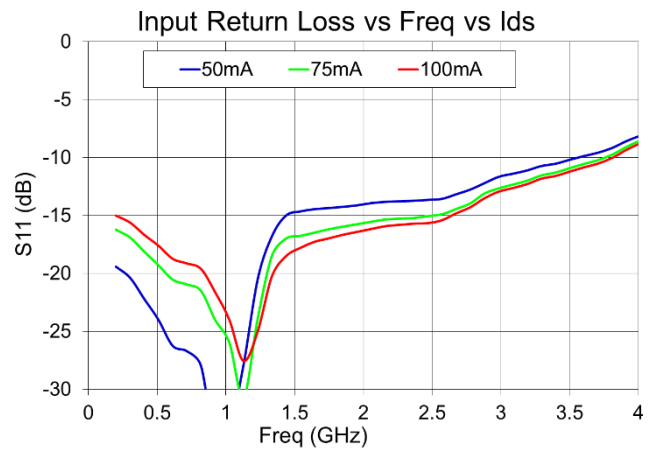
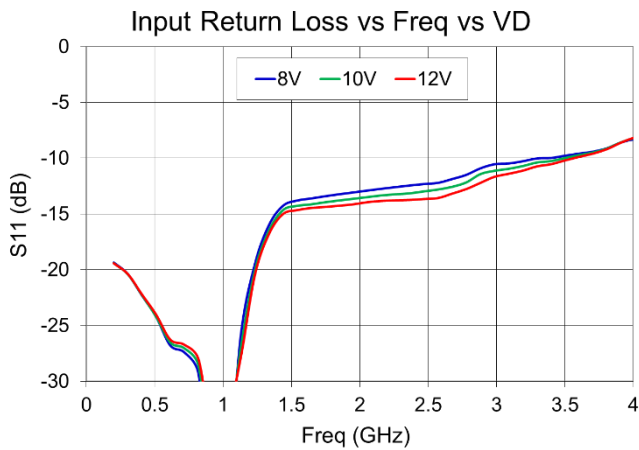
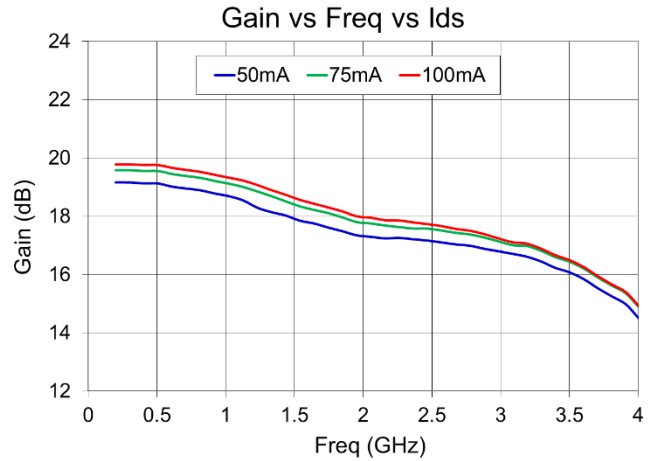
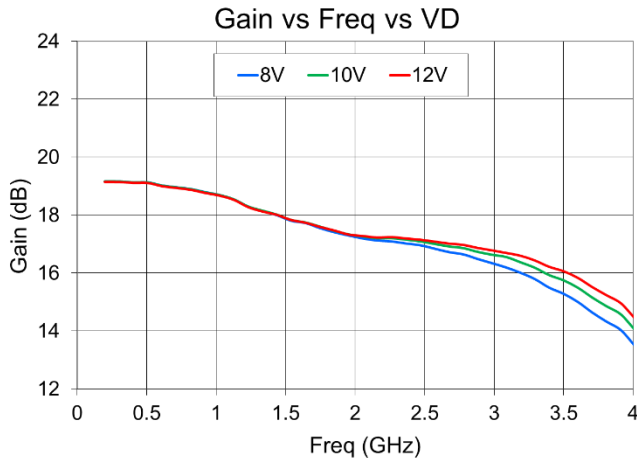

## Performance Plots – Nose Figure

Test Conditions unless otherwise stated:  $V_D = 12V$ ,  $V_C = +2V$ ,  $I_{DQ} = 50mA$ , 25C  
Data de-embedded to device reference plane

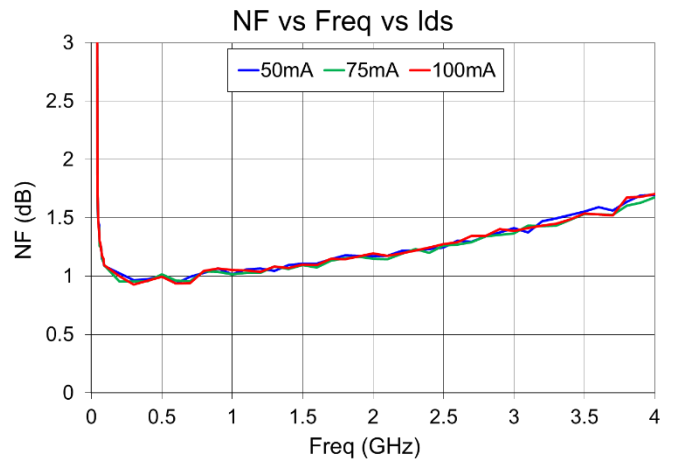
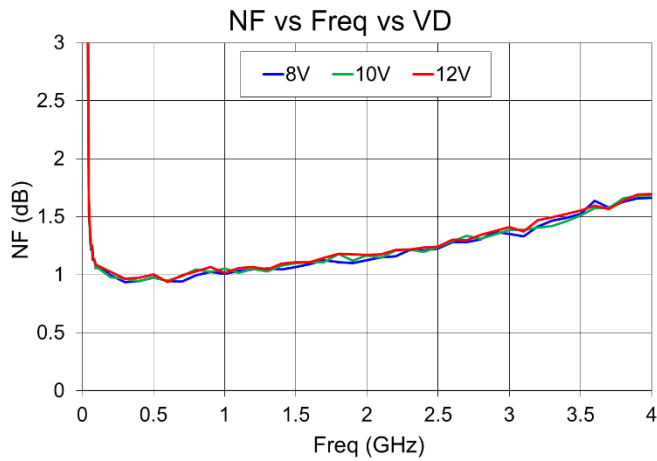
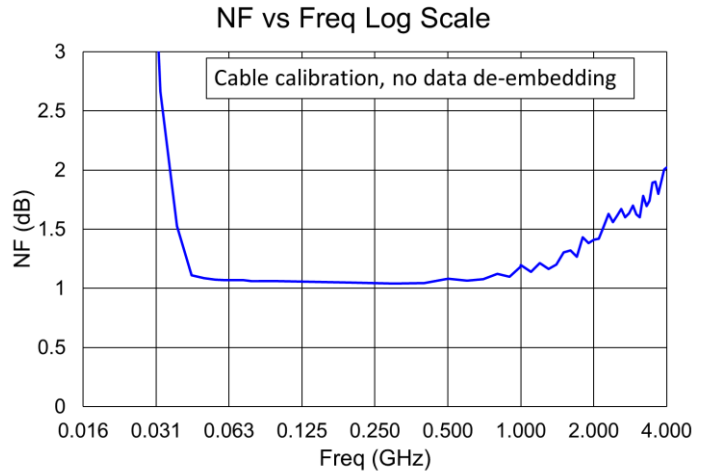
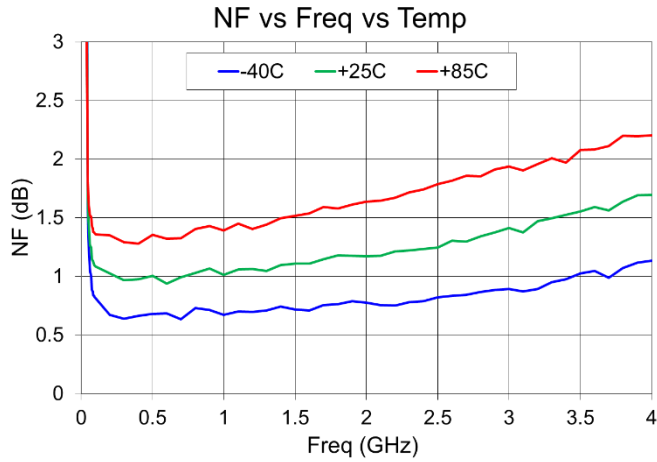

## Performance Plots – Power

Test Conditions unless otherwise stated: VD = 12V, VC = +2V, IDQ = 50mA, 25C  
Data de-embedded to device reference plane

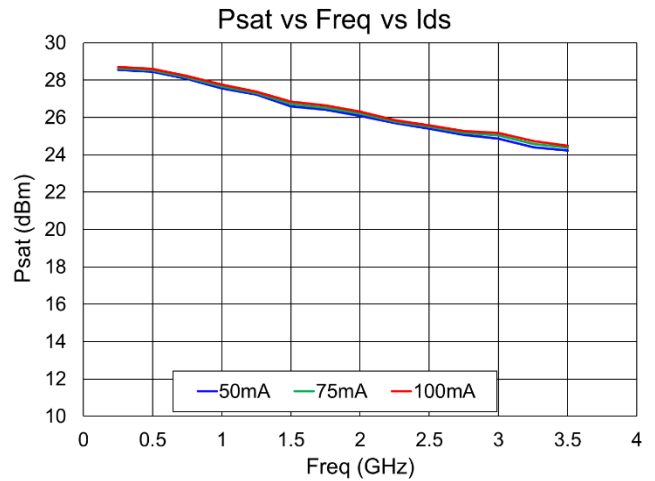
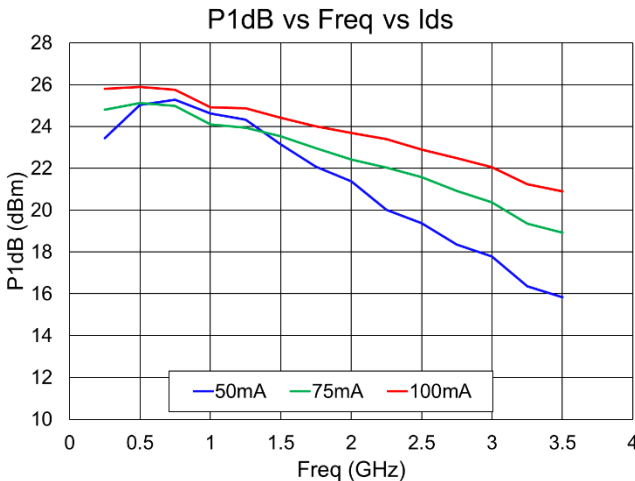
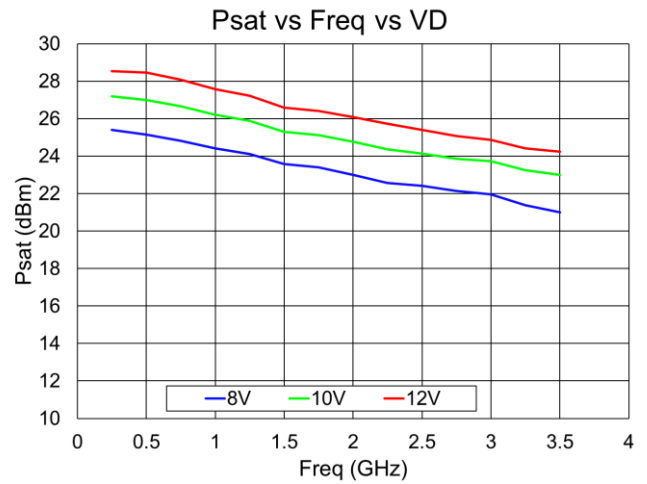
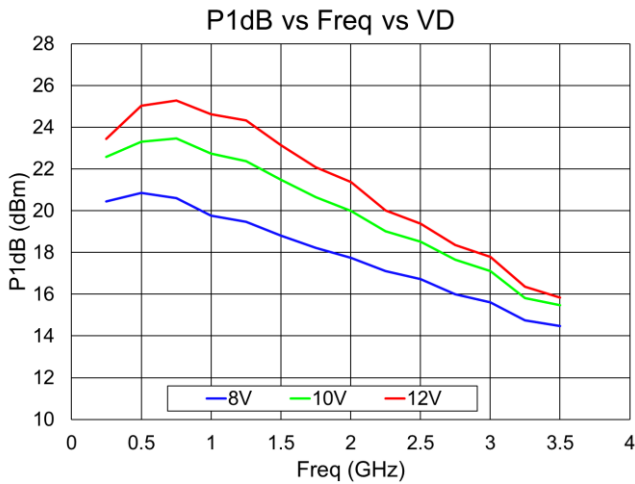
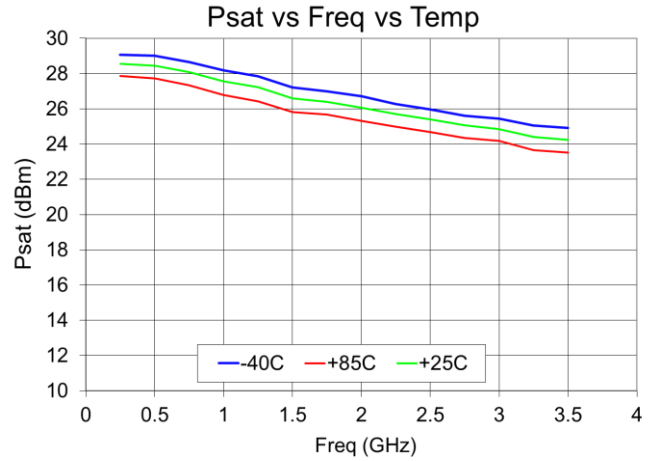
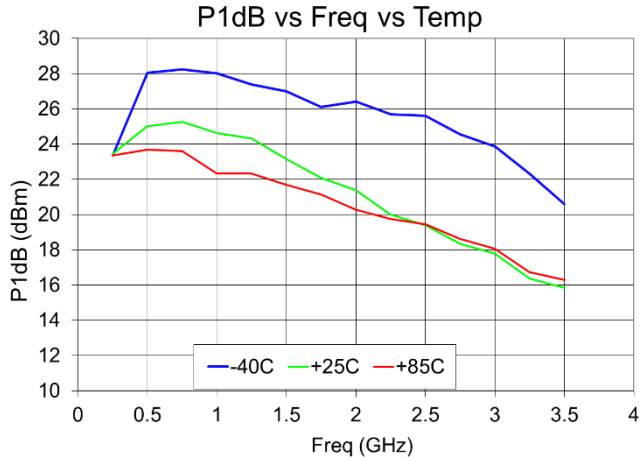

**Performance Plots – Power Sweep**

Test Conditions unless otherwise stated:  $V_D = 12V$ ,  $V_C = +2V$ ,  $I_{DQ} = 40mA$ ,  $25C$   
Data de-embedded to device reference plane

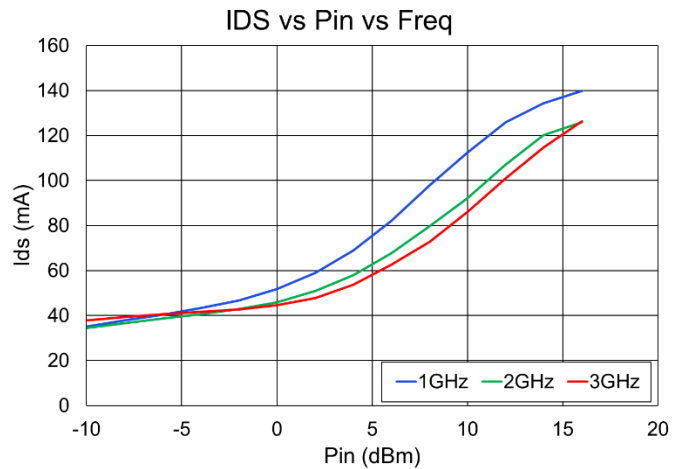
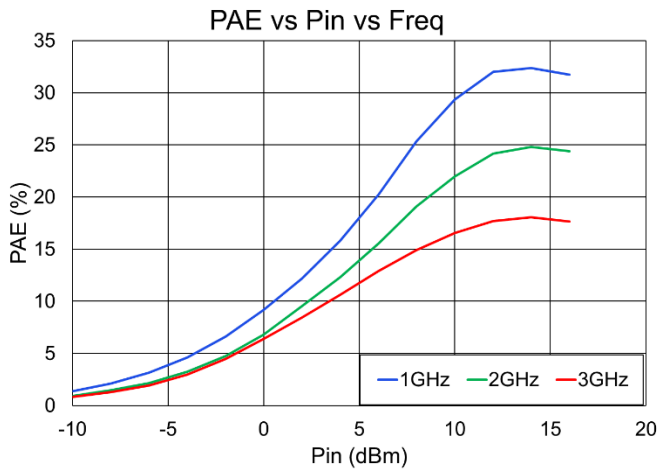
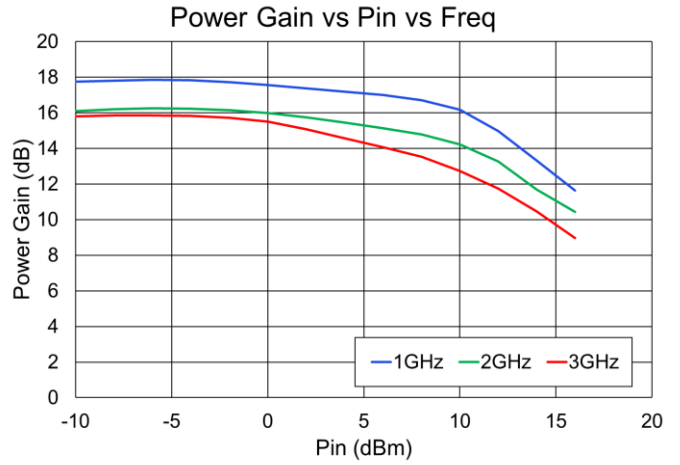
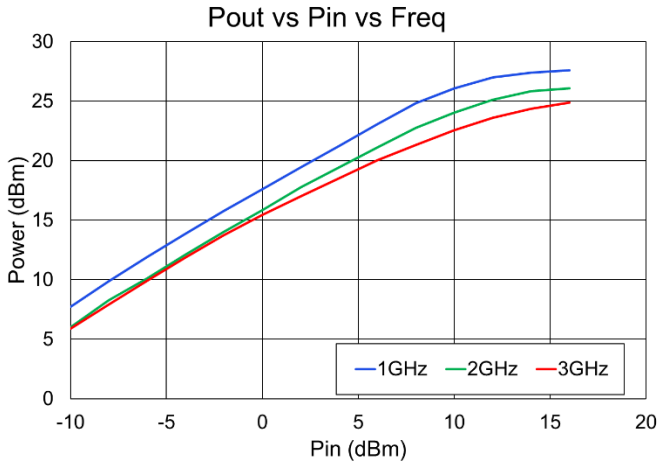

## Performance Plots – Linearity

Test Conditions unless otherwise stated: VD = 12V, VC = +2V, IDQ = 50mA, 25C  
Data de-embedded to device reference plane  
Tone spacing 10MHz, Pin = 4 dBm / tone

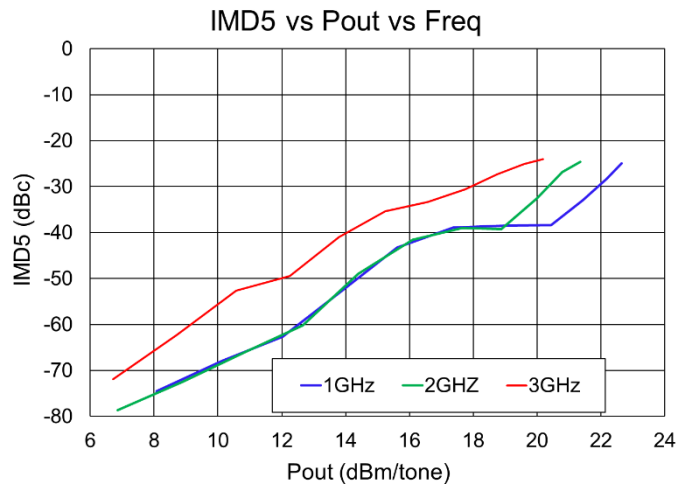
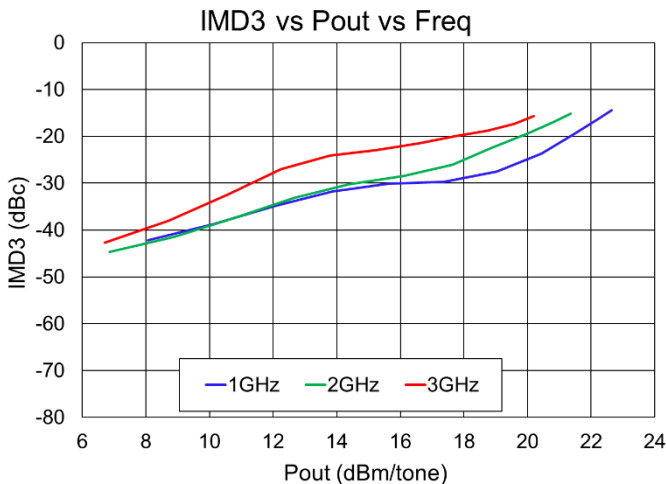
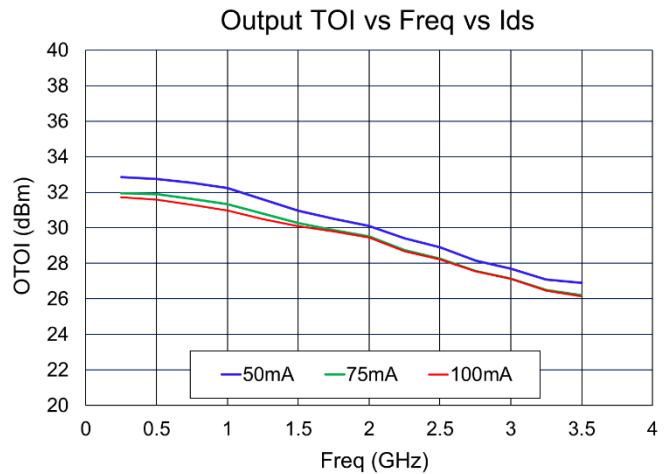
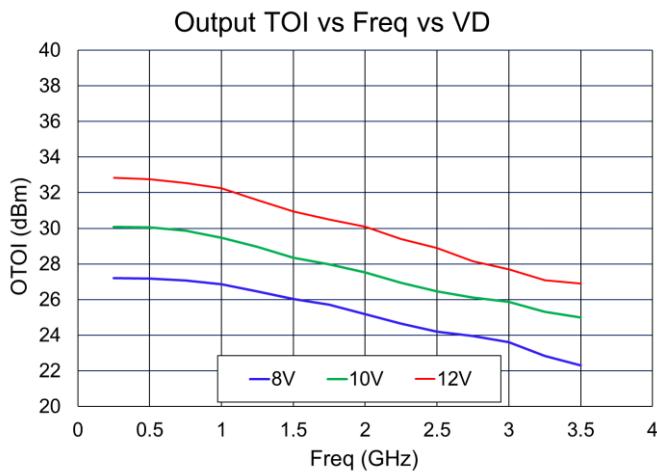
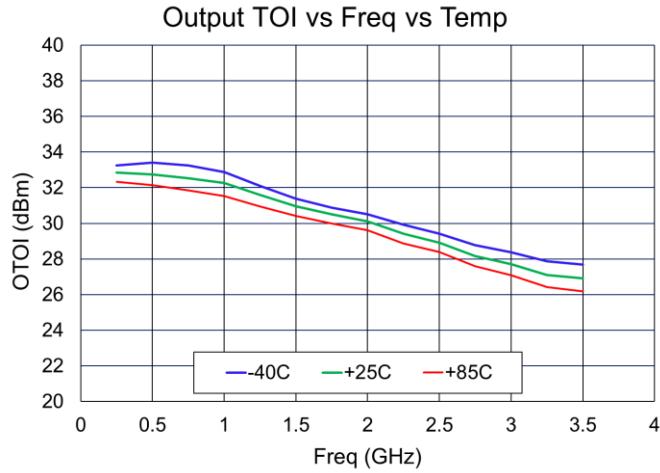



Application Circuit

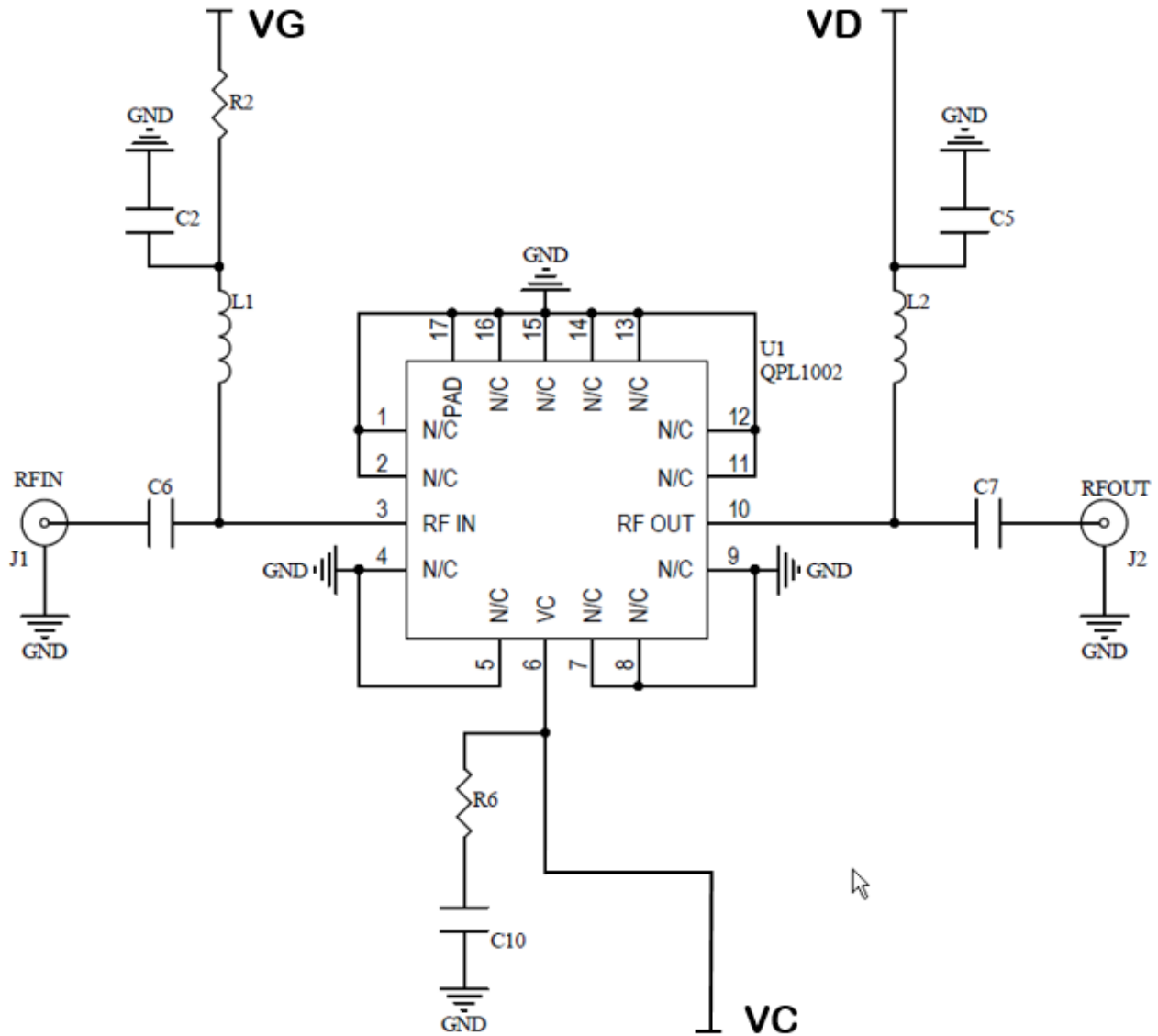

**Bias-up Procedure**

1. Set  $I_D$  limit to 300 mA,  $I_G$  and  $I_C$  limits to 20 mA
2. Set VG to -5 V
3. Set VD +12 V
4. Set VC = +2V
5. Adjust VG more positive until  $IDQ = 50$  mA (- 2.5 V typical)
6. Apply RF signal

**Bias-down Procedure**

1. Turn off RF signal
2. Reduce VG to -5 V, ensure  $IDQ \sim 0$ mA
3. Set VC to 0V
4. Set VD to 0V
5. Turn off VC, VD, VG supplies

## Evaluation Board and Assembly

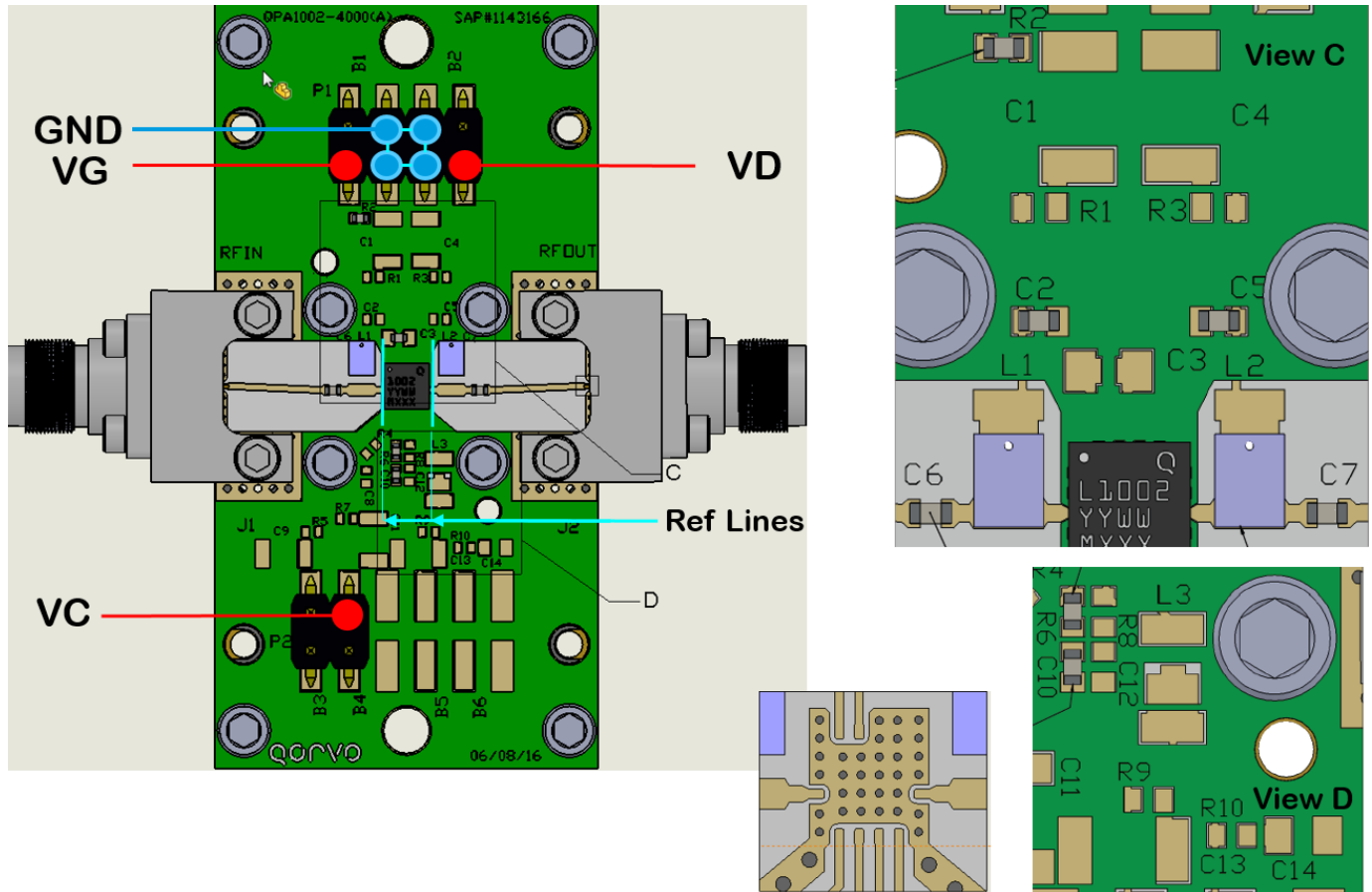

RF Layer is 0.008" thick Rogers Corp. RO4003C ( $\epsilon_r = 3.35$ ). Metal layers are 0.5 oz. copper. The microstrip line at the connector interface is optimized for the Southwest Microwave end launch connector 1492-04A-5.

All data de-embedded to the device reference plane (shown).

## Bill of Materials

Ref. Des.	Component	Value	Manuf.	Part Number
C2, C5-C7, C10	Surface Mount Cap	CAP, 0.01UF +/-10% 50V 0402 X7R, ROHS	Various	
L1, L2	Surface Mount Ind	IND, 560 nH, 5%, 550mA, W/W 0603, ROHS	Various	
R6	Surface Mount Res	RES, 10 Ohm, 5% 0402, 1/16W, ROHS	Various	
R2	Surface Mount Res	RES, 10 Ohm, 5%, 0402, 1/16W, ROHS,	Various	

Mechanical Drawing & Pad Description

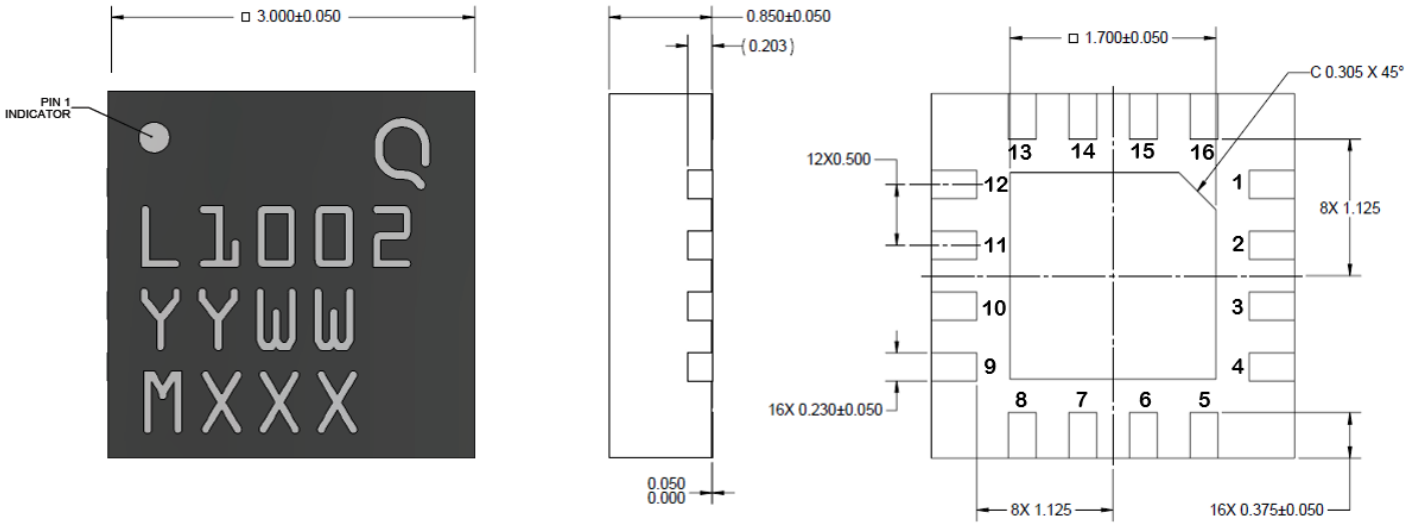

Dimensions in mm  
 Part Marking:  
 L1002: Part Number  
 YY = Part Assembly Year  
 MM = Part Assembly Month  
 MXXX = Batch ID

Pin Number	Label	Description
Slug	GND	GROUND
1, 2, 4, 5, 7-9, 11-16	N/C	No Internal Connection
3	RFIN / VG	RF Input, DC Coupled to Gate
10	RFOUT / VD	RF Output, DC Coupled to Drain
6	VC	Control Voltage

## Thermal and Reliability Information

Parameter	Test Conditions	Value	Units
Thermal Resistance ( $\theta_{JC}$ ) <sup>(1)</sup>	$T_{base} = 85^{\circ}\text{C}$ , $V_D = 12\text{ V}$ , $IDQ = 50\text{ mA}$ Quiescent/Small Signal operation $P_{DISS} = 0.6\text{ W}$	11.34	$^{\circ}\text{C/W}$
Channel Temperature ( $T_{CH}$ )		91.8	$^{\circ}\text{C}$
Median Lifetime ( $T_M$ )		3.31E12	Hrs

Notes:

- Thermal resistance is measured to back of the package.

## Median Lifetime

Test Conditions:  $V_D = 40\text{ V}$   
 Failure Criteria = 10% reduction in  $I_{D\_MAX}$

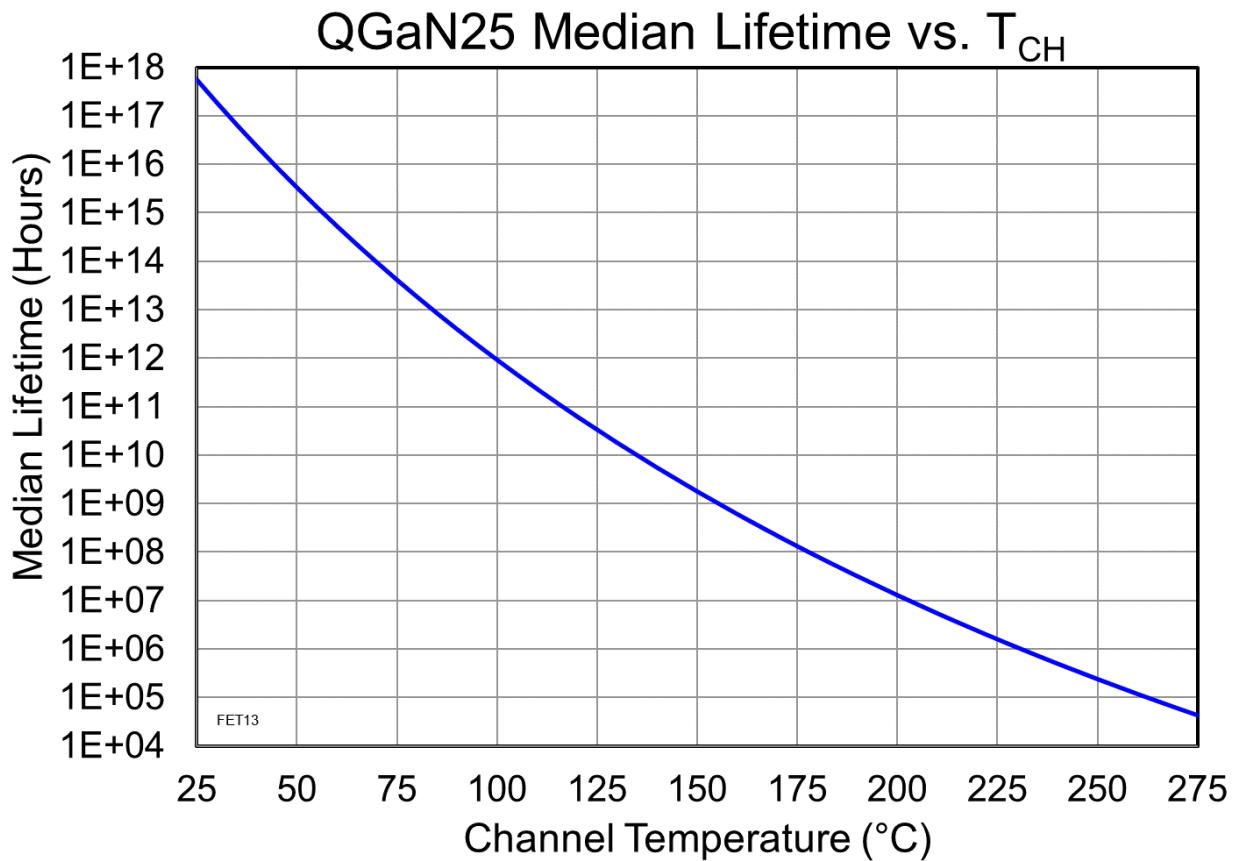

## Solderability

Compatible with the latest version of J-STD-020, Lead-free solder, 260 °C

## Recommended Soldering Temperature Profile

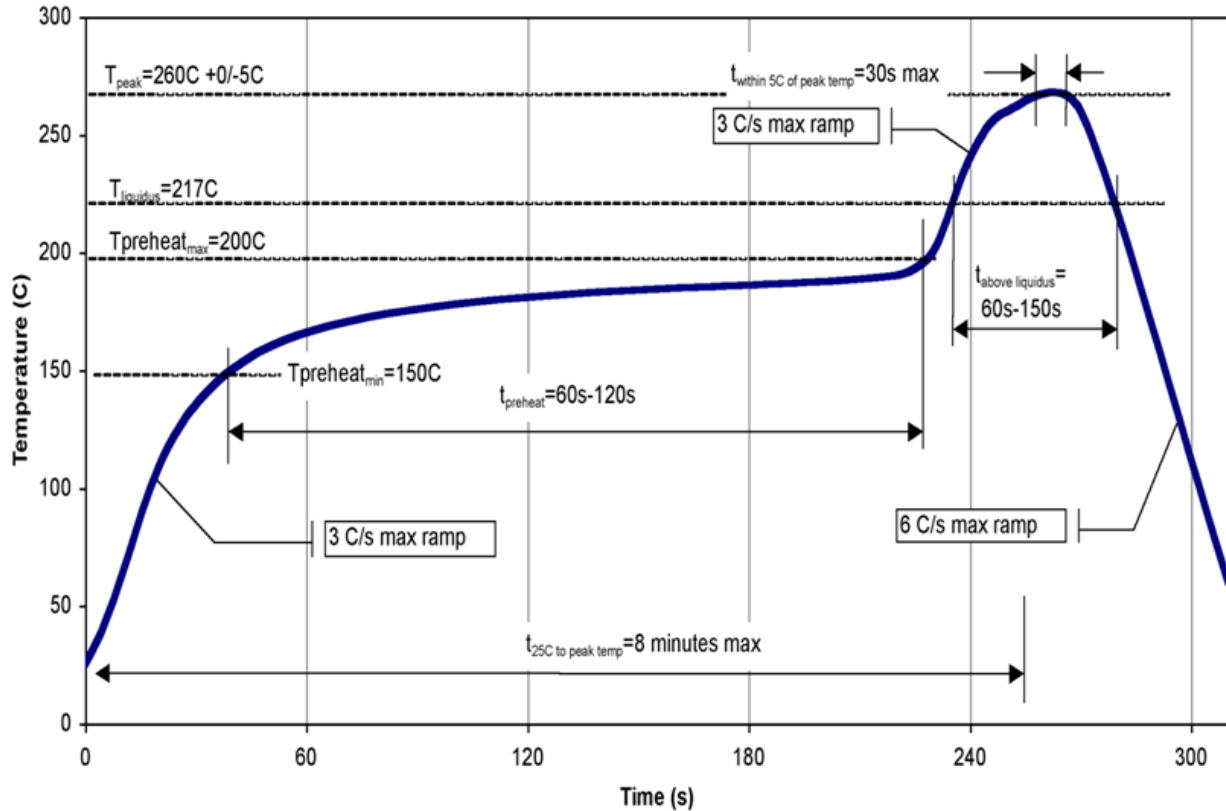

## Handling Precautions

Parameter	Rating	Standard
ESD – Human Body Model (HBM)	Class 1A	ESDA / JEDEC JS-001-2012
ESD – Charged Device Model (CDM)	TBD	ESDA / JEDEC JS-002-2014
MSL – Convection Reflow 260 °C	TBD	JEDEC standard IPC/JEDEC J-STD-020



Caution!  
ESD-Sensitive Device

## RoHS Compliance

This product is compliant with the 2011/65/EU RoHS directive (Restrictions on the Use of Certain Hazardous Substances in Electrical and Electronic Equipment), as amended by Directive 2015/863/EU. This product also has the following attributes:

- Lead Free
- Antimony Free
- TBBP-A (C<sub>15</sub>H<sub>12</sub>Br<sub>4</sub>O<sub>2</sub>) Free
- PFOS Free
- SVHC Free
- Qorvo Green



## Contact Information

For the latest specifications, additional product information, worldwide sales and distribution locations:

**Tel:** 1-844-890-8163

**Web:** [www.qorvo.com](http://www.qorvo.com)

**Email:** [customer.support@qorvo.com](mailto:customer.support@qorvo.com)

For technical questions and application information: **Email:** [appsupport@qorvo.com](mailto:appsupport@qorvo.com)

## Important Notice

The information contained herein is believed to be reliable; however, Qorvo makes no warranties regarding the information contained herein and assumes no responsibility or liability whatsoever for the use of the information contained herein. All information contained herein is subject to change without notice. Customers should obtain and verify the latest relevant information before placing orders for Qorvo products. The information contained herein or any use of such information does not grant, explicitly or implicitly, to any party any patent rights, licenses, or any other intellectual property rights, whether with regard to such information itself or anything described by such information. **THIS INFORMATION DOES NOT CONSTITUTE A WARRANTY WITH RESPECT TO THE PRODUCTS DESCRIBED HEREIN, AND QORVO HEREBY DISCLAIMS ANY AND ALL WARRANTIES WITH RESPECT TO SUCH PRODUCTS WHETHER EXPRESS OR IMPLIED BY LAW, COURSE OF DEALING, COURSE OF PERFORMANCE, USAGE OF TRADE OR OTHERWISE, INCLUDING THE IMPLIED WARRANTIES OF MERCHANTABILITY AND FITNESS FOR A PARTICULAR PURPOSE.**

Without limiting the generality of the foregoing, Qorvo products are not warranted or authorized for use as critical components in medical, life-saving, or life-sustaining applications, or other applications where a failure would reasonably be expected to cause severe personal injury or death.

Copyright 2016 © Qorvo, Inc. | Qorvo is a registered trademark of Qorvo, Inc.