

**Features**

- High Luminous LEDs
- 5mm Bullet Standard Directivity
- Superior Weather-resistance
- UV Resistant Epoxy
- Water Clear Type

**Applications**

- Traffic Signal
- Backlighting
- Signal and channel letter
- Other Lighting

**Outline Dimension**

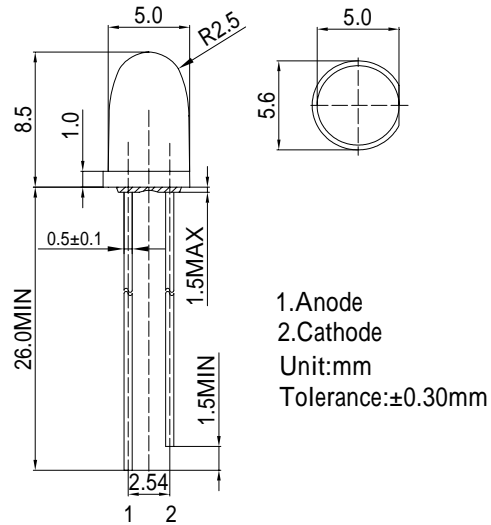

**Absolute Maximum Rating (Ta=25 °C)**

Item	Symbol	Value	Unit
DC Forward Current	I <sub>F</sub>	50	mA
Pulse Forward Current*	I <sub>FP</sub>	120	mA
Reverse Voltage	V <sub>R</sub>	5	V
Power Dissipation	P <sub>D</sub>	130	mW
Operating Temperature	T <sub>opr</sub>	-30 ~ +85	
Storage Temperature	T <sub>stg</sub>	-40 ~ +100	
Lead Soldering Temperature	T <sub>sol</sub>	260 / 5sec	-

**Directivity**

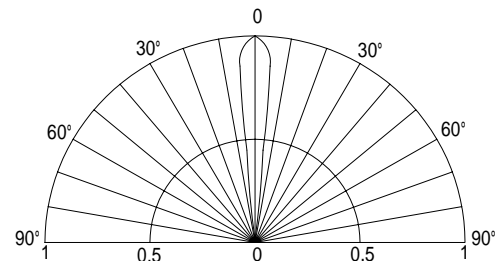

\*Pulse width Max.10ms Duty ratio max 1/10

**Electrical -Optical Characteristics (Ta=25 °C)**

Item	Symbol	Condition	Min.	Typ.	Max.	Unit
DC Forward Voltage	V <sub>F</sub>	I <sub>F</sub> =20mA	1.8	2.1	2.6	V
DC Reverse Current	I <sub>R</sub>	V <sub>R</sub> =5V	-	-	10	μA
Domi. Wavelength*	λ <sub>D</sub>	I <sub>F</sub> =20mA	620	625	630	nm
Luminous Intensity*	I <sub>v</sub>	I <sub>F</sub> =20mA	50000	60000	-	mcd
50% Power Angle	2θ <sub>1/2</sub>	I <sub>F</sub> =20mA	-	8	-	deg

\*1 Tolerance of dominant wavelength is ±1nm  
\*2 Tolerance of luminous intensity is ±15%

**Maximum Forward Current**

