

MAX17232/MAX17233**3.5V–36V, 2.2MHz, Synchronous Dual Buck Controller with 20 μ A Quiescent Current****General Description**

The MAX17232/MAX17233 offers dual synchronous step-down DC-DC controllers with integrated MOSFETs. They operate over a 3.5V to 36V input voltage range with 42V input transient protection, and can operate in dropout condition by running at 95% duty cycle. The controllers can generate fixed output voltages of 3.3V/5V, along with the capability to program the output voltage between 1V to 10V.

These devices use a current-mode-control architecture. The devices can be operated in pulse-width modulation (PWM) or pulse-frequency modulation (PFM) control schemes. PWM operation provides constant frequency operation at all loads, and is useful in applications sensitive to switching frequency. PFM operation disables negative inductor current and additionally skips pulses at light loads for high efficiency. The low-resistance, on-chip MOSFETs ensure high efficiency at full load and simplify the layout.

The devices are available in a 28-pin TQFN-EP package with exposed pad, and are specified for operation over -40°C to +85°C.

Applications

- Distributed Supply Regulation
- Wall Transformer Regulation
- General-Purpose Point-of-Load

Benefits and Features

- Eliminates External Components and Reduces Total Cost
 - No Schottky-Synchronous Operation for High Efficiency and Reduced Cost
 - Simple External RC Compensation for Stable Operation at Any Output Voltage
 - All-Ceramic Capacitor Solution: Ultra-Compact Layout
 - 180° Out-of-Phase Operation Reduces Output Ripple and Enables Cascaded Power Supplies
- Reduces Number of DC-DC Controllers to Stock
 - Fixed Output Voltage with $\pm 1\%$ Accuracy (5V/3.3V) or Externally Resistor Adjustable (1V to 10V)
 - 220kHz to 2.2MHz Adjustable Frequency with External Synchronization
 - Frequency Synchronization Input
- Reduces Power Dissipation
 - 92% Peak Efficiency
 - 8 μ A (typ) in Shutdown
 - 20 μ A (typ) Quiescent Current in PFM Mode
- Operates Reliably
 - 42V Input Voltage Transient Protection
 - Cycle-by-Cycle Current Limit, Thermal Shutdown
 - Supply Overvoltage and Undervoltage Lockout
 - Power-OK Monitor
 - Reduced EMI Emission with Spread-Spectrum Control
 - 50ns (typ) Minimum On-Time Guarantees PWM Operation at Low Duty Cycle at 2.2MHz

[Ordering Information](#) and [Selector Guide](#) appears at end of data sheet.

Typical Application Circuit

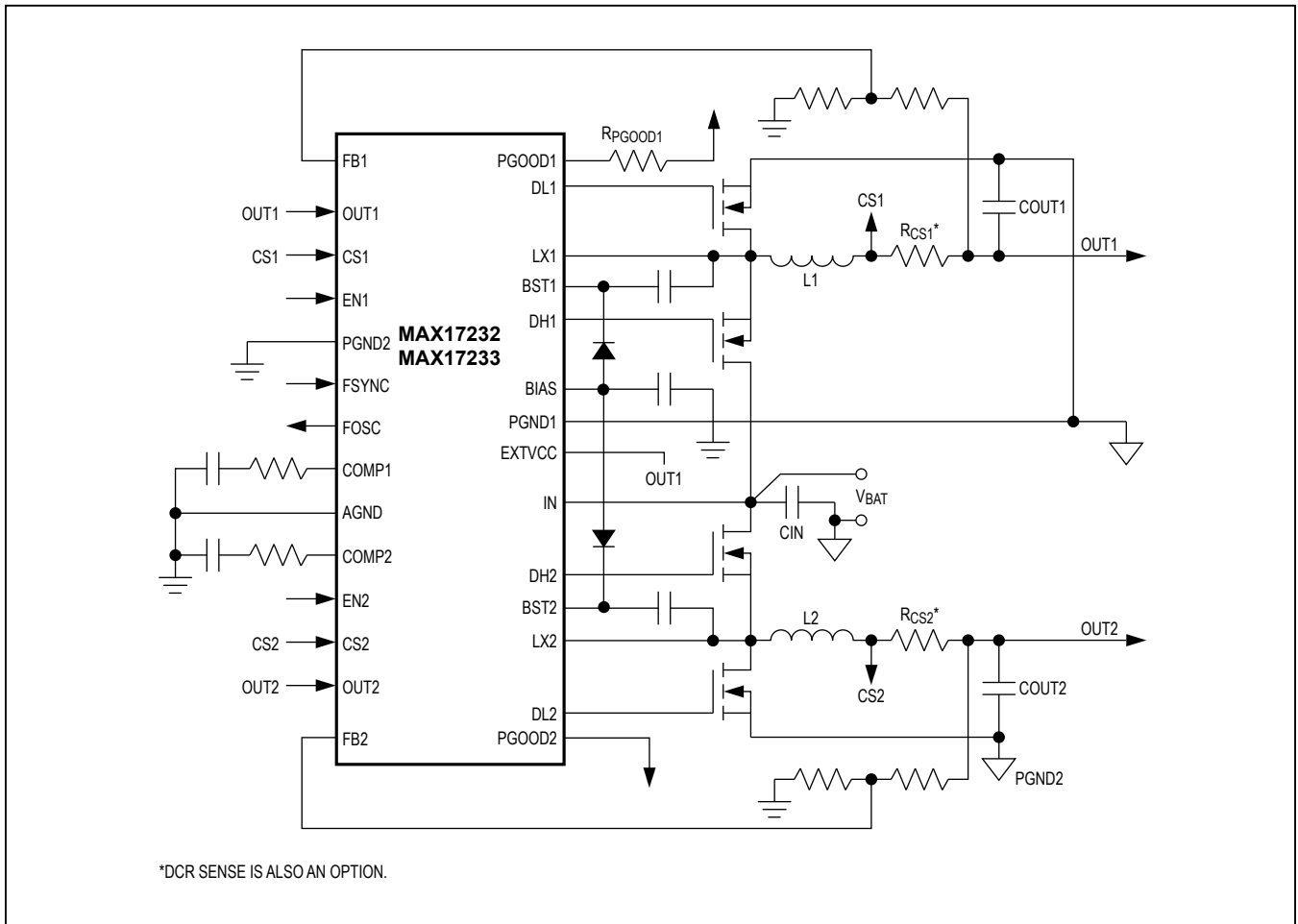

Absolute Maximum Ratings

IN, EN1, EN2, TERM to PGND_.....	-0.3V to +42V	LX_ to PGND_.....	-0.3V to +42V
CS1, CS2, OUT1, OUT2 to AGND.....	-0.3V to +11V	PGND_ to AGND.....	-0.3V to +0.3V
CS1 to OUT1.....	-0.2V to +0.2V	PGOOD1, PGOOD2 to AGND.....	-0.3V to +6.0V
CS2 to OUT2.....	-0.2V to +0.2V	Continuous Power Dissipation (T _A = +70°C)	
BIAS, FSYNC, FOSC to AGND.....	-0.3V to +6.0V	TQFN (derate 28.6mW/NC above +70°C).....	2285.7mW
COMP1, COMP2 to AGND.....	-0.3V to +6.0V	Operating Temperature Range.....	-40°C to +85°C
FB1, FB2, EXT _{VCC} to AGND.....	-0.3V to +6.0V	Junction Temperature Range.....	+150°C
DL_ to PGND_.....	-0.3V to +6.0V	Storage Temperature Range.....	-65°C to +150°C
BST_ to LX_.....	-0.3V to + 6.0V	Lead Temperature (soldering, 10s).....	+300°C
DH_ to LX_.....	-0.3V to + 6.0V	Soldering Temperature (reflow).....	+260°C

Stresses beyond those listed under "Absolute Maximum Ratings" may cause permanent damage to the device. These are stress ratings only, and functional operation of the device at these or any other conditions beyond those indicated in the operational sections of the specifications is not implied. Exposure to absolute maximum rating conditions for extended periods may affect device reliability.

Package Thermal Characteristics (Note 1)

TQFN

Junction-to-Ambient Thermal Resistance (θ _{JA}).....	35°C/W	Junction-to-Case Thermal Resistance (θ _{JC}).....	3°C/W
--	--------	---	-------

Note 1: Package thermal resistances were obtained using the method described in JEDEC specification JESD51-7, using a four-layer board. For detailed information on package thermal considerations, refer to www.maximintegrated.com/thermal-tutorial.

Electrical Characteristics

(V_{IN} = 14V, V_{BIAS} = 5V, C_{BIAS} = 6.8µF, T_A = T_J = -40°C to +85°C, unless otherwise noted. Typical values are at T_A = +25°C under normal conditions, unless otherwise noted.) (Note 2)

PARAMETER	SYMBOL	CONDITIONS	MIN	TYP	MAX	UNIT
SYNCHRONOUS STEP-DOWN DC-DC CONTROLLERS						
Supply Voltage Range	V _{IN}	Normal operation	3.5		36	V
		t < 1s			42	
Output Overvoltage Threshold		FB rising (Note 3)	+10	+15	+20	%
		FB falling	+5	+10	+15	
Supply Current	I _{IN}	V _{EN1} = V _{EN2} = 0V, T _A = +25°C		8	20	µA
		V _{EN1} = V _{EN2} = 0V, T _A = +125°C		20		
		V _{EN1} = 5V, V _{OUT1} = 5V, V _{EN2} = 0V; V _{EXTVCC} = 5V, no switching		30	40	
		V _{EN2} = 5V, V _{OUT2} = 3.3V; V _{EN1} = 0V, V _{EXTVCC} = 3.3V, no switching		20	30	
		V _{EN1} = V _{EN2} = 5V, V _{OUT1} = 5V, V _{OUT2} = 3.3V, V _{EXTVCC} = 3.3V, no switching		25	40	
Buck 1 Fixed Output Voltage	V _{OUT1}	V _{FB1} = V _{BIAS} , PWM mode	4.95	5	5.05	V
		V _{FB1} = V _{BIAS} , skip mode	4.95	5	5.075	
Buck 2 Fixed Output Voltage	V _{OUT2}	V _{FB2} = V _{BIAS} , PWM mode	3.234	3.3	3.366	V
		V _{FB2} = V _{BIAS} , skip mode	3.234	3.3	3.4	
Output Voltage Adjustable Range		Buck 1, buck 2	1		10	V

Electrical Characteristics (continued)

($V_{IN} = 14V$, $V_{BIAS} = 5V$, $C_{BIAS} = 6.8\mu F$, $T_A = T_J = -40^\circ C$ to $+85^\circ C$, unless otherwise noted. Typical values are at $T_A = +25^\circ C$ under normal conditions, unless otherwise noted.) (Note 2)

PARAMETER	SYMBOL	CONDITIONS	MIN	TYP	MAX	UNIT
Regulated Feedback Voltage	$V_{FB1,2}$		0.99	1.0	1.01	V
Feedback Leakage Current	$I_{FB1,2}$	$T_A = +25^\circ C$		0.01	1	μA
Feedback Line Regulation Error		$V_{IN} = 3.5V$ to $36V$, $V_{FB} = 1V$		0.001		%/V
Transconductance (from FB_ to COMP_)	g_m	$V_{FB} = 1V$, $V_{BIAS} = 5V$		1200	2400	μS
Dead Time		MAX17233: DL_ low to DH_ high		35		ns
		MAX17233: DH_ low to DL_ high		60		
		MAX17232: DL_ low to DH_ high		60		
		MAX17232: DH_ low to DL_ high		100		
Maximum Duty Cycle		Buck 1, buck 2	95	98.5		%
Minimum On-Time	$t_{ON(MIN)}$	Buck 1, buck 2		50		ns
PWM Switching Frequency	f_{SW}	MAX17233	1		2.2	MHz
		MAX17232	0.2		1	
Buck 2 Switching Frequency		MAX17233ATIT+, MAX17233BATIU+ only		$1/2f_{SW}$		MHz
Switching Frequency Accuracy		MAX17233: $R_{FOSC} = 13.7k\Omega$, $V_{BIAS} = 5V$	1.98	2.2	2.42	MHz
		MAX17232: $R_{FOSC} = 80.6k\Omega$, $V_{BIAS} = 5V$	360	400	440	kHz
Spread-Spectrum Range		Spread spectrum enabled		± 6		%
FSYNC INPUT						
FSYNC Frequency Range		MAX17233: Minimum sync pulse of 100ns	1.2		2.4	MHz
		MAX17232: Minimum sync pulse of 400ns	240		1200	kHz
FSYNC Switching Thresholds		High threshold	1.5			V
		Low threshold			0.6	
CS Current-Limit Voltage Threshold	$V_{LIMIT1,2}$	$V_{CS} - V_{OUT}$, $V_{BIAS} = 5V$, $V_{OUT} \geq 2.5V$	64	80	96	mV
Skip Mode Threshold				15		mV
Soft-Start Ramp Time		Buck 1 and buck 2, fixed soft-start time regardless of frequency	2	6	10	ms
Phase Shift Between Buck1 and Buck 2				180		$^\circ$
LX1, LX2 Leakage Current		$V_{IN} = 6V$, $V_{LX_} = V_{IN}$, $T_A = +25^\circ C$		0.01		μA
DH1, DH2 Pullup Resistance		$V_{BIAS} = 5V$, $I_{DH_} = -100mA$		10	20	Ω
DH1, DH2 Pulldown Resistance		$V_{BIAS} = 5V$, $I_{DH_} = +100mA$		2	4	Ω
DL1, DL2 Pullup Resistance		$V_{BIAS} = 5V$, $I_{DL_} = -100mA$		4	8	Ω
DL1, DL2 Pulldown Resistance		$V_{BIAS} = 5V$, $I_{DL_} = +100mA$		1.5	3	Ω

Electrical Characteristics (continued)

($V_{IN} = 14V$, $V_{BIAS} = 5V$, $C_{BIAS} = 6.8\mu F$, $T_A = T_J = -40^\circ C$ to $+85^\circ C$, unless otherwise noted. Typical values are at $T_A = +25^\circ C$ under normal conditions, unless otherwise noted.) (Note 2)

PARAMETER	SYMBOL	CONDITIONS	MIN	TYP	MAX	UNIT
PGOOD1, PGOOD2 Threshold	PGOOD_H	% of $V_{OUT_}$, rising	85	90	95	%
	PGOOD_F	% of $V_{OUT_}$, falling	80	85	90	
PGOOD1, PGOOD2 Leakage Current		$V_{PGOOD1,2} = 5V$, $T_A = +25^\circ C$		0.01	1	µA
PGOOD1, PGOOD2 Startup Delay Time		Buck 1 and buck 2 after soft-start is complete		64		Cycles
PGOOD1, PGOOD2 Debounce Time		Fault detection	8	20	50	µs
INTERNAL LDO: BIAS						
Internal BIAS Voltage		$V_{IN} > 6V$	4.75	5	5.25	V
BIAS UVLO Threshold		V_{BIAS} rising		3.1	3.4	V
		V_{BIAS} falling	2.7	2.9		
Hysteresis				0.2		V
External V_{CC}	$V_{TH,EXTVCC}$	EXTVCC rising, HYST = 110mV		3.0	3.2	V
THERMAL OVERLOAD						
Thermal-Shutdown Temperature		(Note 4)		+170		°C
Thermal-Shutdown Hysteresis		(Note 4)		20		°C
EN LOGIC INPUT						
High Threshold			1.8			V
Low Threshold					0.8	V
Input Current		$T_A = +25^\circ C$			1	µA

Note 2: Limits are 100% production tested at $T_A = +25^\circ C$. Limits over the operating temperature range and relevant supply voltage range are guaranteed by design and characterization. Typical values are at $T_A = +25^\circ C$.

Note 3: Overvoltage protection is detected at the FB1/FB2 pins. If the feedback voltage reaches overvoltage threshold of FB1/FB2 + 15% (typ), the corresponding controller stops switching. The controllers resume switching once the output drops below FB1/FB2 + 10% (typ).

Note 4: Guaranteed by design; not production tested.

Typical Operating Characteristics

(T_A = +25°C, unless otherwise noted.)

NO LOAD STARTUP SEQUENCE
(V_{FSYNC} = 0V)

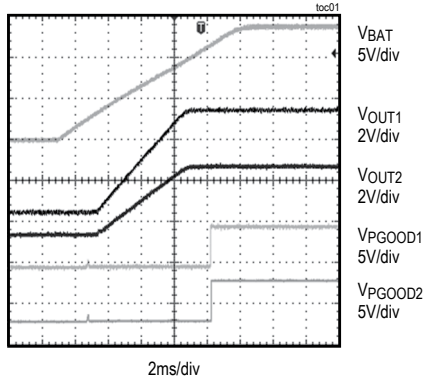

FULL LOAD STARTUP SEQUENCE
(V_{FSYNC} = 0V)

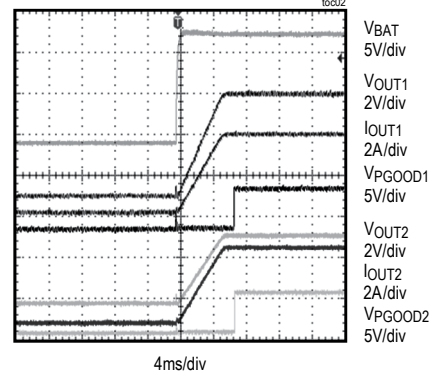

QUIESCENT CURRENT
vs. TEMPERATURE

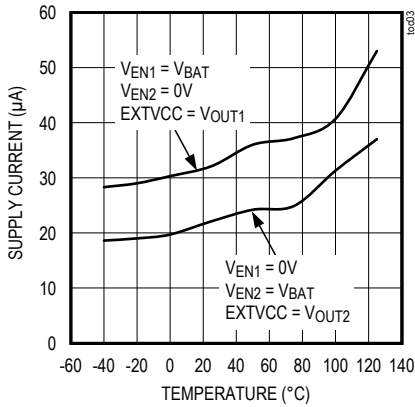

QUIESCENT CURRENT
vs. SUPPLY VOLTAGE

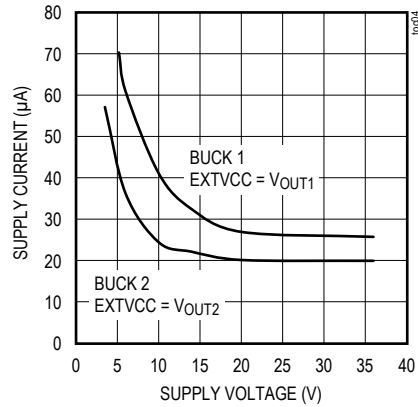

BUCK1 EFFICIENCY

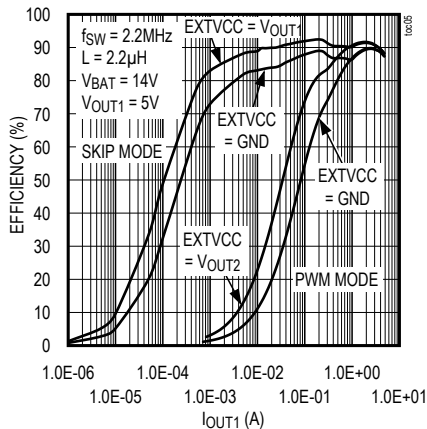

BUCK2 EFFICIENCY

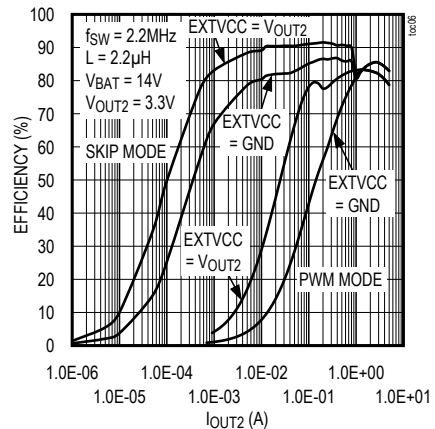

Typical Operating Characteristics (continued)

(T_A = +25°C, unless otherwise noted.)

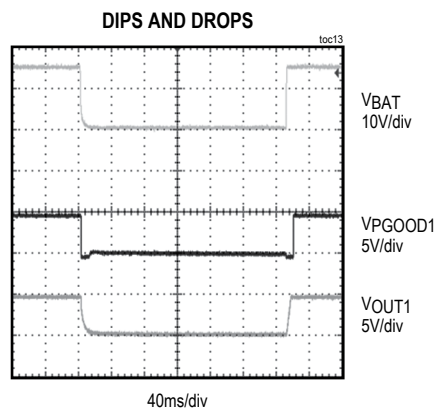
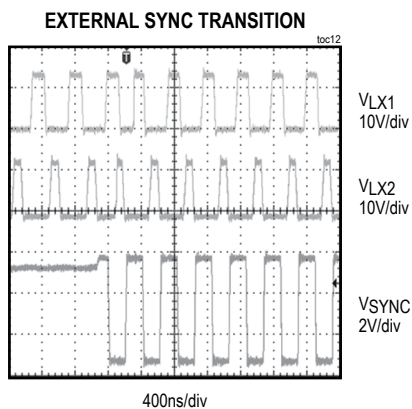
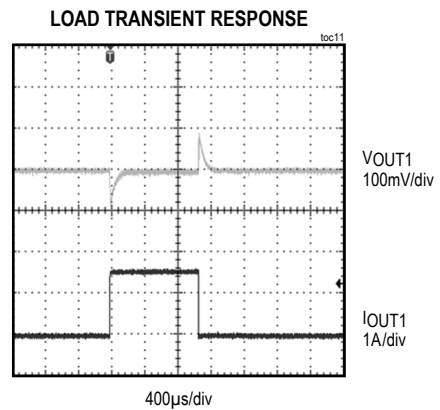
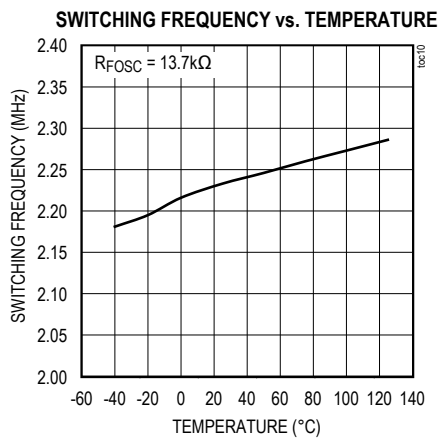
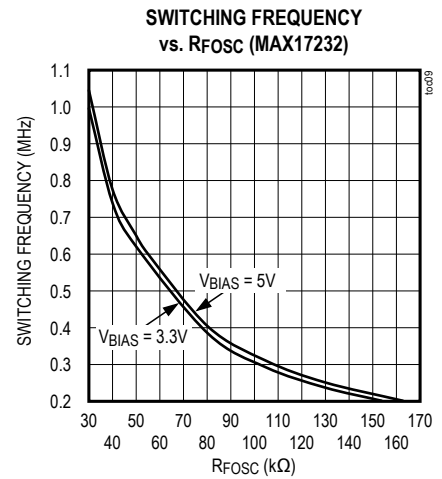
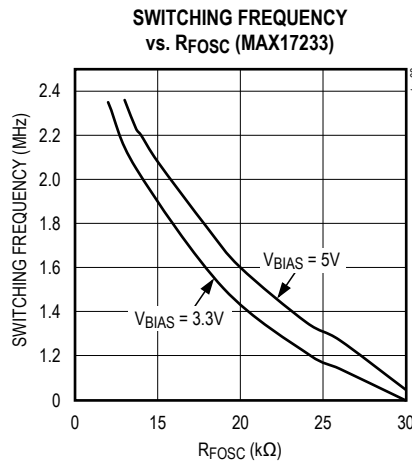
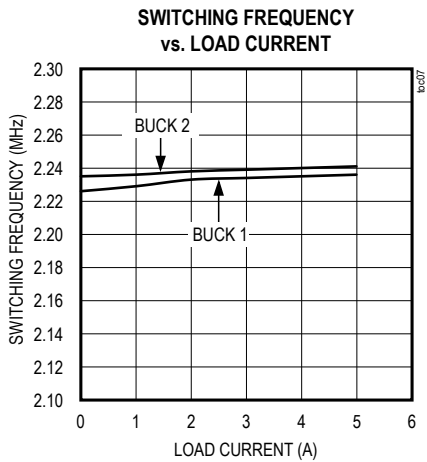

Typical Operating Characteristics (continued)

(T_A = +25°C, unless otherwise noted.)

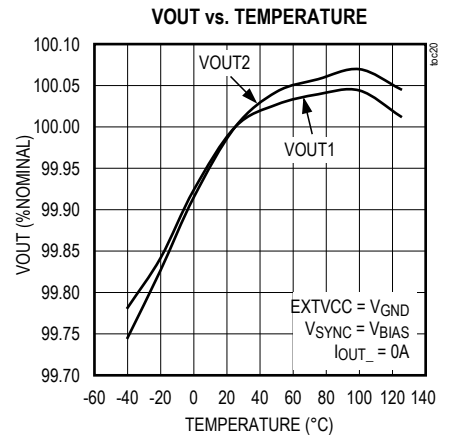
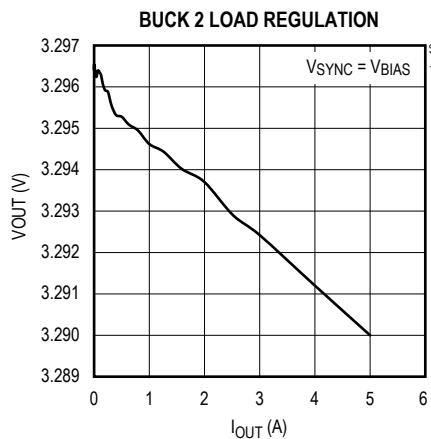
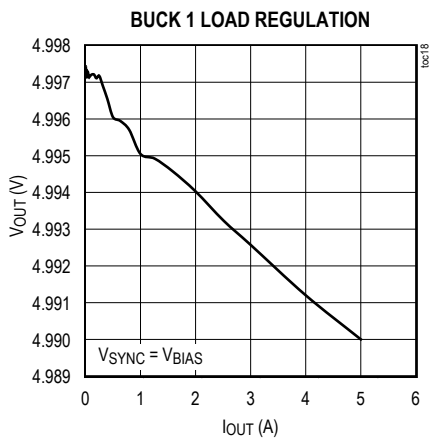
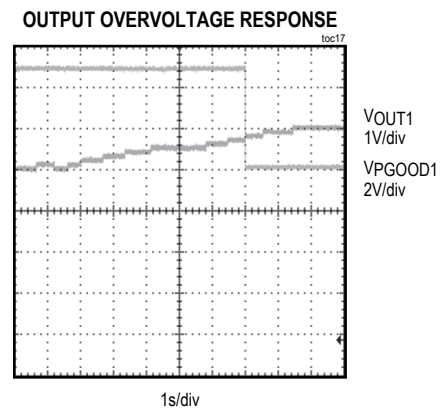
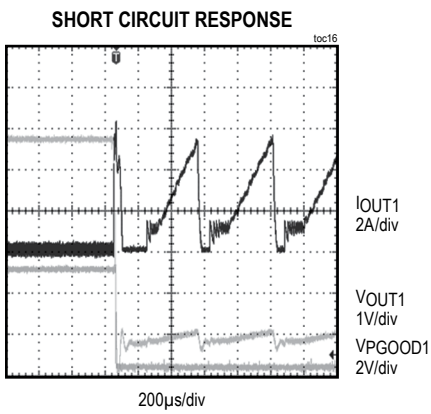
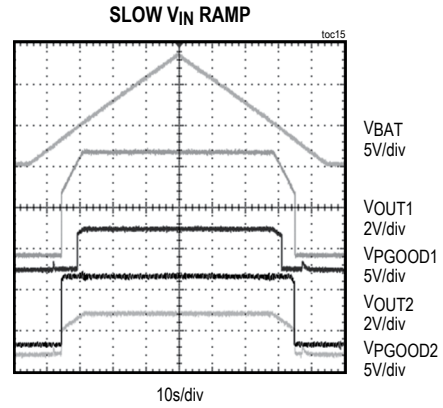
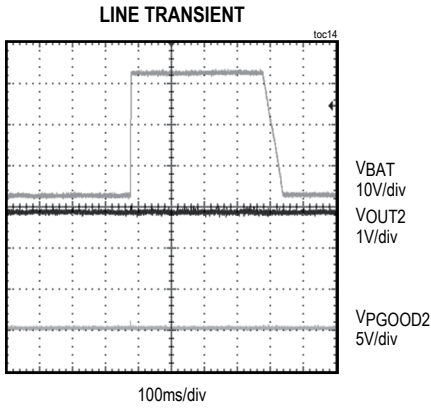

Typical Operating Characteristics (continued)

(T_A = +25°C, unless otherwise noted.)

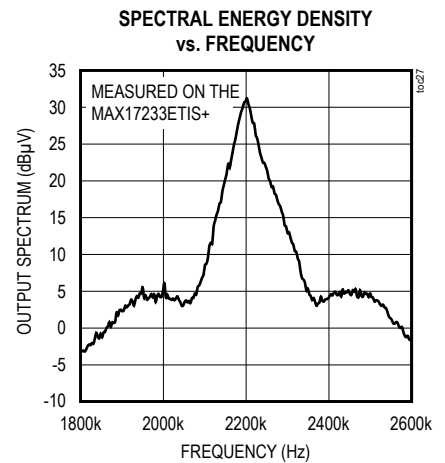
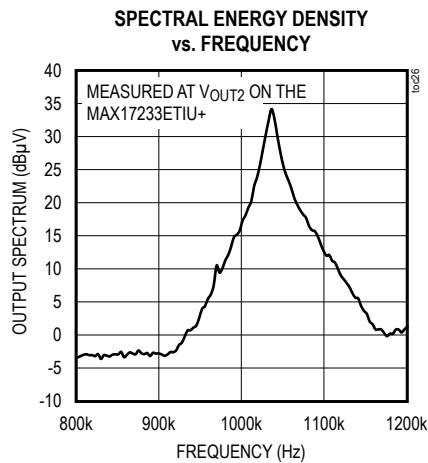
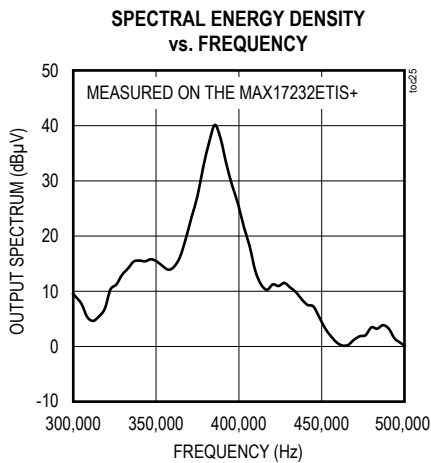
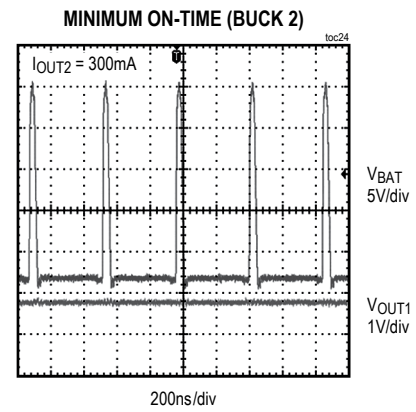
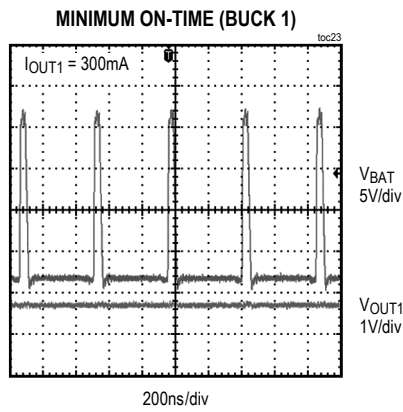
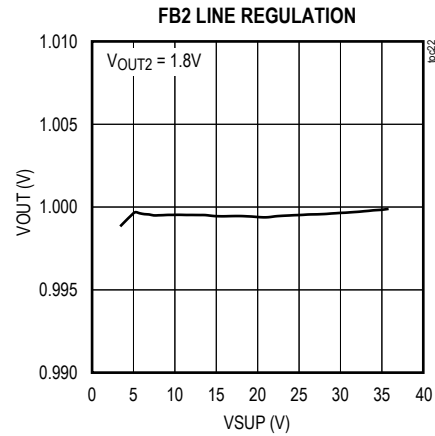
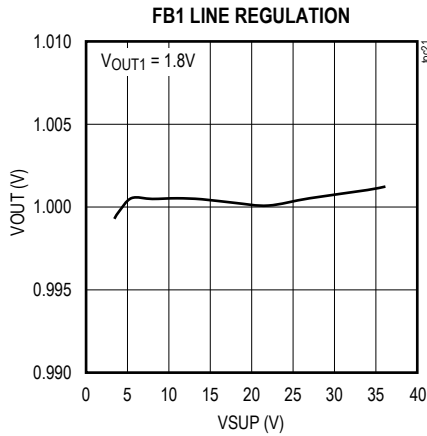

Pin Configuration

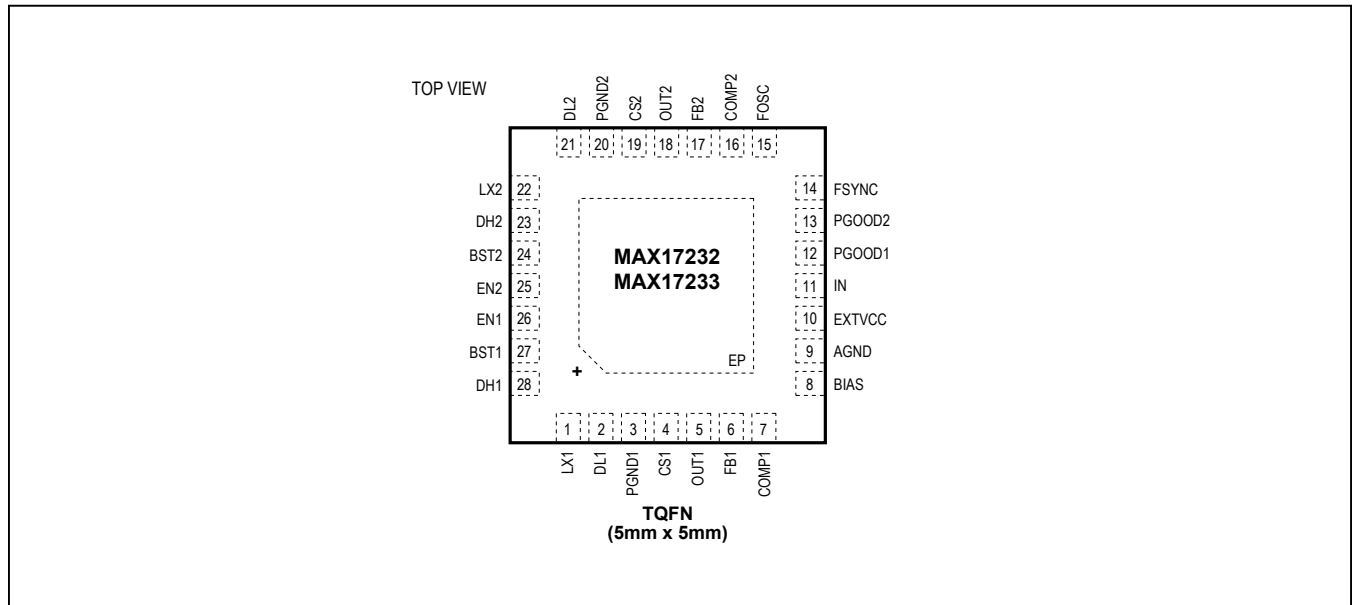

Pin Description

PIN	NAME	DESCRIPTION
1	LX1	Inductor Connection for Buck 1. Connect LX1 to the switched side of the inductor. LX1 serves as the lower supply rail for the DH1 high-side gate drive.
2	DL1	Low-Side Gate Drive Output for Buck 1. DL1 output voltage swings from V_{PGND1} to V_{BIAS} .
3	PGND1	Power Ground for Buck 1
4	CS1	Positive Current-Sense Input for Buck 1. Connect CS1 to the positive terminal of the current-sense resistor. See the <i>Current Limiting</i> and <i>Current-Sense Inputs</i> and <i>Current-Sense Measurement</i> sections.
5	OUT1	Output Sense and Negative Current-Sense Input for Buck 1. When using the internal preset 5V feedback divider (FB1 = BIAS), the buck uses OUT1 to sense the output voltage. Connect OUT1 to the negative terminal of the current-sense resistor. See the <i>Current Limiting</i> and <i>Current-Sense Inputs</i> and <i>Current-Sense Measurement</i> sections.
6	FB1	Feedback Input for Buck 1. Connect FB1 to BIAS for the 5V fixed output or to a resistive divider between OUT1 and GND to adjust the output voltage between 1V and 10V. In adjustable mode, FB1 regulates to 1V (typ). See the <i>Setting the Output Voltage in Buck Converters</i> section.
7	COMP1	Buck 1 Error-Amplifier Output. Connect an RC network to COMP1 to compensate buck 1.
8	BIAS	5V Internal Linear Regulator Output. Bypass BIAS to GND with a low-ESR ceramic capacitor of 6.8µF minimum value. BIAS provides the power to the internal circuitry and external loads. See the <i>Fixed 5V Linear Regulator (BIAS)</i> section.
9	AGND	Signal Ground for IC
10	EXTVCC	3.1V to 5.2V Input to the Switchover Comparator
11	IN	Supply Input. Bypass IN with sufficient capacitance to supply the two out-of-phase buck converters.

Pin Description (continued)

PIN	NAME	DESCRIPTION
12	PGOOD1	Open-Drain Power-Good Output for Buck 1. PGOOD1 is low if OUT1 is more than 15% (typ) below the normal regulation point. PGOOD1 asserts low during soft-start and in shutdown. PGOOD1 becomes high impedance when OUT1 is in regulation. To obtain a logic signal, pullup PGOOD1 with an external resistor connected to a positive voltage lower than 5.5V. Place a minimum of 100Ω (R_{PGOOD1}) in series with PGOOD1. See the <i>Voltage Monitoring</i> section for details.
13	PGOOD2	Open-Drain Power-Good Output for Buck 2. PGOOD2 is low if OUT2 is more than 15% (typ) below the normal regulation point. PGOOD2 asserts low during soft-start and in shutdown. PGOOD2 becomes high impedance when OUT2 is in regulation. To obtain a logic signal, pullup PGOOD2 with an external resistor connected to a positive voltage lower than 5.5V.
14	FSYNC	External Clock Synchronization Input. Synchronization to the controller operating frequency ratio is 1. Keep f_{SYNC} a minimum of 10% greater than the maximum internal switching frequency for stable operation. See the <i>Switching Frequency/External Synchronization</i> section.
15	FOSC	Frequency Setting Input. Connect a resistor from FOSC to AGND to set the switching frequency of the DC-DC converters.
16	COMP2	Buck 2 Error Amplifier Output. Connect an RC network to COMP2 to compensate buck 2.
17	FB2	Feedback Input for Buck 2. Connect FB2 to BIAS for the 3.3V fixed output or to a resistive divider between OUT2 and GND to adjust the output voltage between 1V and 10V. In adjustable mode, FB2 regulates to 1V (typ). See the <i>Setting the Output Voltage in Buck Converters</i> section.
18	OUT2	Output Sense and Negative Current-Sense Input for Buck 2. When using the internal preset 3.3V feedback-divider (FB2 = BIAS), the buck uses OUT2 to sense the output voltage. Connect OUT2 to the negative terminal of the current-sense resistor. See the <i>Current Limiting</i> and <i>Current-Sense Inputs and Current-Sense Measurement</i> sections.
19	CS2	Positive Current-Sense Input for Buck 2. Connect CS2 to the positive terminal of the current-sense resistor. See the <i>Current Limiting</i> and <i>Current-Sense Inputs and Current-Sense Measurement</i> sections.
20	PGND2	Power Ground for Buck 2
21	DL2	Low-Side Gate Drive Output for Buck 2. DL2 output voltage swings from V_{PGND2} to V_{BIAS} .
22	LX2	Inductor Connection for Buck 2. Connect LX2 to the switched side of the inductor. LX2 serves as the lower supply rail for the DH2 high-side gate drive.
23	DH2	High-Side Gate Drive Output for Buck 2. DH2 output voltage swings from V_{LX2} to V_{BST2} .
24	BST2	Boost Capacitor Connection for High-Side Gate Voltage of Buck 2. Connect a high-voltage diode between BIAS and BST2. Connect a ceramic capacitor between BST2 and LX2. See the <i>High-Side Gate-Driver Supply (BST_)</i> section.
25	EN2	High-Voltage Tolerant, Active-High Digital Enable Input for Buck 2. Driving EN2 high enables buck 2.
26	EN1	High-Voltage Tolerant, Active-High Digital Enable Input for Buck 1. Driving EN1 high enables buck 1.
27	BST1	Boost Capacitor Connection for High-Side Gate Voltage of Buck 1. Connect a high-voltage diode between BIAS and BST1. Connect a ceramic capacitor between BST1 and LX1. See the <i>High-Side Gate-Driver Supply (BST_)</i> section.
28	DH1	High-Side Gate-Drive Output for Buck 1. DH1 output voltage swings from V_{LX1} to V_{BST1} .
—	EP	Exposed Pad. Connect the exposed pad to ground. Connecting the exposed pad to ground does not remove the requirement for proper ground connections to PGND1, PGND2, and AGND. The exposed pad is attached with epoxy to the substrate of the die, making it an excellent path to remove heat from the IC.

Detailed Description

The MAX17232/MAX17233 are dual-output switching power supplies. These devices integrate two synchronous step-down controllers and can provide two independent controlled power rails as follows:

- A buck controller with a fixed 5V output voltage or an adjustable 1V to 10V output voltage.
- A buck controller with a fixed 3.3V output voltage or an adjustable 1V to 10V output voltage.

The two buck controllers can each provide up to 10A output current and are independently controllable.

EN1 and EN2 enable the respective buck controllers. Connect EN1 and EN2 directly to V_{BAT}, or to power-supply sequencing logic.

In skip mode, with no load and only buck 2 active, the total supply current is reduced to 20µA (typ). When both controllers are disabled, the total current drawn is further reduced to 8µA (typ).

Fixed 5V Linear Regulator (BIAS)

The internal circuitry of the devices requires a 5V bias supply. An internal 5V linear regulator (BIAS) generates this bias supply. Bypass BIAS with a 6.8µF or greater ceramic capacitor to guarantee stability under the full-load condition.

The internal linear regulator can source up to 100mA (150mA under EXTVCC switchover, see the [EXTVCC Switchover](#) section). Use the following equation to estimate the internal current requirements for the devices:

$$I_{BIAS} = I_{CC} + f_{SW}(Q_{G_DH1} + Q_{G_DL1} + Q_{G_DH2} + Q_{G_DL2}) = 10\text{mA to } 50\text{mA (typ)}$$

where I_{CC} is the internal supply current, 5mA (typ), f_{SW} is the switching frequency, and $Q_{G_}$ is the MOSFET's total gate charge (specification limits at $V_{GS} = 5\text{V}$). To minimize the internal power dissipation, bypass BIAS to an external 5V rail.

EXTVCC Switchover

The internal linear regulator can be bypassed by connecting an external supply (3V to 5.2V) or the output of one of the buck converters to EXTVCC. BIAS internally switches to EXTVCC and the internal linear regulator turns off. This configuration has several advantages:

- It reduces the internal power dissipation of the devices.
- The low-load efficiency improves as the internal supply current gets scaled down proportionally to the duty cycle.

If V_{EXTVCC} drops below $V_{TH,EXTVCC} = 3\text{V (min)}$, the internal regulator enables and switches back to BIAS.

Undervoltage Lockout (UVLO)

The BIAS input undervoltage lockout (UVLO) circuitry inhibits switching if the 5V bias supply (BIAS) is below its 2.9V (typ) UVLO falling threshold. Once the 5V bias supply (BIAS) rises above its UVLO rising threshold and EN1 and EN2 enable the buck controllers, the controllers start switching and the output voltages begin to ramp up using soft-start.

Buck Controllers

The devices provide two buck controllers with synchronous rectification. The step-down controllers use a PWM, current-mode control scheme. External logic-level MOSFETs allow for optimized load-current design. Fixed-frequency operation with optimal interleaving minimizes input ripple current from the minimum to the maximum input voltages. Output-current sensing provides an accurate current limit with a sense resistor or power dissipation can be reduced using lossless current sensing across the inductor.

Soft-Start

Once a buck converter is enabled by driving the corresponding EN_ high, the soft-start circuitry gradually ramps up the reference voltage during soft-start time ($t_{SSTART} = 6\text{ms}$ (typ)) to reduce the input surge currents during startup. Before the device can begin the soft-start, the following conditions must be met:

- 1) V_{BIAS} exceeds the 3.4V (max) undervoltage-lockout threshold.
- 2) $V_{EN_}$ is logic-high.

Switching Frequency/External Synchronization

The MAX17232 provides an internal oscillator adjustable from 1MHz to 2.2MHz. The MAX17233 provides an internal oscillator adjustable from 200kHz to 1MHz. High-frequency operation optimizes the application for the smallest component size, trading off efficiency to higher switching losses. Low-frequency operation offers the best overall efficiency at the expense of component size and board space. To set the switching frequency, connect a resistor R_{FOSC} from FOSC to AGND. See TOC8 and TOC9 (Switching Frequency vs. R_{FOSC}) in the [Typical Operating Characteristics](#) to determine the relationship between switching frequency and R_{FOSC} .

Buck 1 is synchronized with the internal clock-signal rising edge, while buck 2 is synchronized with the clock-signal falling edge.

The devices can be synchronized to an external clock by connecting the external clock signal to FSYNC. A rising edge on FSYNC resets the internal clock. Keep the FSYNC frequency between 110% and 150% of the internal frequency. The FSYNC signal should have a 50% duty cycle.

Light-Load Efficiency Skip Mode ($V_{FSYNC} = 0V$)

Drive FSYNC low to enable skip mode. In skip mode, the devices stop switching until the FB voltage drops below the reference voltage. Once the FB voltage has dropped below the reference voltage, the devices begin switching until the inductor current reaches 20% (skip threshold) of the maximum current defined by the inductor DCR or output shunt resistor.

Forced-PWM Mode ($V_{FSYNC} = \text{High}$)

Driving FSYNC high prevents the devices from entering skip mode by disabling the zero-crossing detection of the inductor current. This forces the low-side gate-driver waveform to constantly be the complement of the high-side gate-drive waveform, so the inductor current reverses at light loads and discharges the output capacitor. The benefit of forced PWM mode is to keep the switching frequency constant under all load conditions. However, forced-frequency operation diverts a considerable amount of the output current to PGND, reducing the efficiency under light-load conditions.

Forced-PWM mode is useful for improving load-transient response and eliminating unknown frequency harmonics that may interfere with AM radio bands.

Spread Spectrum

The MAX17233ETIS, MAX17233ETIU, and MAX17232ETIS feature enhanced EMI performance. They perform $\pm 6\%$ dithering of the switching frequency to reduce peak emission noise at the clock frequency and its harmonics, making it easier to meet stringent emission limits.

When using an external clock source (i.e., driving the FSYNC input with an external clock), spread spectrum is disabled.

Buck 2 Switching Frequency

For the MAX17233ETIT and MAX17232BATIU, the switching frequency of buck 2 is set to 1/2 of f_{SW} (buck 1 switching frequency). When using these devices, the external components of buck 2 should be sized to account for the reduced switching frequency (see the [Design Procedure](#) section).

MOSFET Gate Drivers (DH_ and DL_)

The DH_ high-side nMOSFET drivers are powered from capacitors at BST_ while the low-side drivers (DL_) are powered by the 5V linear regulator (BIAS). On each channel, a shoot-through protection circuit monitors the gate-to-source voltage of the external MOSFETs to prevent a MOSFET from turning on until the complementary switch is fully off. There must be a low-resistance, low-inductance path from the DL_ and DH_ drivers to the MOSFET gates for the protection circuits to work properly. Follow the instructions listed to provide the necessary low-resistance and low-inductance path:

- Use very short, wide traces (50 mils to 100 mils wide if the MOSFET is 1in from the driver).

It may be necessary to decrease the slew rate for the gate drivers to reduce switching noise or to compensate for low-gate charge capacitors. For the low-side drivers, use gate capacitors in the range of 1nF to 5nF from DL_ to GND. For the high-side drivers, connect a small 5Ω to 10Ω resistor between BST_ and the bootstrap capacitor.

Note: Gate drivers must be protected during shutdown, at the absence of the supply voltage ($V_{BIAS} = 0V$) when the gate is pulled high either capacitively or by the leakage path on the PCB. Therefore, external gate pulldown resistors are needed, to prevent making a direct path from V_{BAT} to GND.

High-Side Gate-Driver Supply (BST_)

The high-side MOSFET is turned on by closing an internal switch between BST_ and DH_ and transferring the bootstrap capacitor's (at BST_) charge to the gate of the high-side MOSFET. This charge refreshes when the high-side MOSFET turns off and the LX_ voltage drops down to ground potential, taking the negative terminal of the capacitor to the same potential. At this time the bootstrap diode recharges the positive terminal of the bootstrap capacitor.

The selected high-side nMOSFET determines the appropriate boost capacitance values ($C_{BST_}$ in the [Typical Application Circuit](#)) according to the following equation:

$$C_{BST_} = \frac{Q_G}{\Delta V_{BST_}}$$

where Q_G is the total gate charge of the high-side MOSFET and $\Delta V_{BST_}$ is the voltage variation allowed on the high-side MOSFET driver after turn-on. Choose $\Delta V_{BST_}$ such that the available gate-drive voltage is not significantly degraded (e.g., $\Delta V_{BST_} = 100mV$ to $300mV$) when determining $C_{BST_}$.

The boost capacitor should be a low-ESR ceramic capacitor. A minimum value of 100nF works in most cases.

Current Limiting and Current-Sense Inputs (OUT_ and CS_)

The current-limit circuit uses differential current-sense inputs (OUT_ and CS_) to limit the peak inductor current. If the magnitude of the current-sense signal exceeds the current-limit threshold ($V_{LIMIT1,2} = 80mV$ (typ)), the PWM controller turns off the high-side MOSFET. The actual maximum load current is less than the peak current-limit threshold by an amount equal to half of the inductor ripple current. Therefore, the maximum load capability is a function of the current-sense resistance, inductor value, switching frequency, and duty cycle ($V_{OUT_}/V_{IN}$).

For the most accurate current sensing, use a current-sense shunt resistor (R_{SH}) between the inductor and the output capacitor. Connect CS_ to the inductor side of R_{SH} and OUT_ to the capacitor side. Dimension R_{SH} such that the maximum inductor current ($I_{L,MAX} = I_{LOAD,MAX} + 1/2 I_{RIPPLE,PP}$) induces a voltage of $V_{LIMIT1,2}$ across R_{SH} including all tolerances.

For higher efficiency, the current can also be measured directly across the inductor. This method could cause up to 30% error over the entire temperature range and requires a filter network in the current-sense circuit. See the [Current-Sense Measurement](#) section.

Voltage Monitoring (PGOOD_)

The devices include several power-monitoring signals to facilitate power-supply sequencing and supervision. PGOOD_ can be used to enable circuits that are supplied by the corresponding voltage rail, or to turn on subsequent supplies.

Each PGOOD_ goes high (high impedance) when the corresponding regulator output voltage is in regulation. Each PGOOD_ goes low when the corresponding regulator output voltage drops below 15% (typ) or rises above 15% (typ) of its nominal regulated voltage. Connect a 10kΩ (typ) pullup resistor from PGOOD_ to the relevant logic rail to level-shift the signal.

PGOOD_ asserts low during soft-start, soft-discharge, and when either buck converter is disabled (either EN1 or EN2 is low).

To ensure latchup immunity on the PGOOD1 pin, a minimum resistance of 100Ω should be placed between the PGOOD1 pin and any other external components.

Thermal-Overload, Overcurrent, and Overvoltage and Undervoltage Behavior

Thermal-Overload Protection

Thermal-overload protection limits total power dissipation in the devices. When the junction temperature exceeds +170°C, an internal thermal sensor shuts down the devices, allowing them to cool. The thermal sensor turns on the devices again after the junction temperature cools by 20°C.

Overcurrent Protection

If the inductor current in the MAX17232/MAX17233 exceeds the maximum current limit programmed at CS_{_} and OUT_{_}, the respective driver turns off. In an overcurrent mode, this results in shorter and shorter high-side pulses.

A hard short results in a minimum on-time pulse every clock cycle. Choose the components so they can withstand the short-circuit current if required.

Overvoltage Protection

The devices limit the output voltage of the buck converters by turning off the high-side gate driver at approximately 115% of the regulated output voltage. The output voltage needs to come back in regulation before the high-side gate driver starts switching again.

Design Procedure

Buck Converter Design Procedure

Effective Input Voltage Range in Buck Converters

Although the MAX17232/MAX17233 can operate from input supplies up to 36V (42V transients) and regulate down to 1V, the minimum voltage conversion ratio (V_{OUT}/V_{IN}) might be limited by the minimum controllable on-time. For proper fixed-frequency PWM operation and optimal efficiency, buck 1 and buck 2 should operate in continuous conduction during normal operating conditions. For continuous conduction, set the voltage conversion ratio as follows:

$$\frac{V_{OUT}}{V_{IN}} > t_{ON(MIN)} \times f_{SW}$$

where $t_{ON(MIN)}$ is 50ns (typ) and f_{SW} is the switching frequency in Hz. If the desired voltage conversion does not meet the above condition, pulse skipping occurs to decrease the effective duty cycle. Decrease the switching frequency if constant switching frequency is required. The same is true for the maximum voltage conversion ratio.

The maximum voltage conversion ratio is limited by the maximum duty cycle (95%).

$$\frac{V_{OUT}}{V_{IN} - V_{DROP}} < 0.95$$

where $V_{DROP} = I_{OUT} (R_{ON,HS} + R_{DCR})$ is the sum of the parasitic voltage drops in the high-side path and f_{SW} is the programmed switching frequency. During low drop operation, the devices reduce f_{SW} to 25% (max) of the programmed frequency. In practice, the above condition should be met with adequate margin for good load-transient response.

Setting the Output Voltage in Buck Converters

Connect FB1 and FB2 to BIAS to enable the fixed buck controller output voltages (5V and 3.3V) set by a preset internal resistive voltage-divider connected between the output (OUT_{_}) and AGND. To externally adjust the output voltage between 1V and 10V, connect a resistive divider from the output (OUT_{_}) to FB_{_} to AGND (see the [Typical Application Circuit](#)). Calculate R_{FB_1} and R_{FB_2} with the following equation:

$$R_{FB_1} = R_{FB_2} \left[\left(\frac{V_{OUT_}}{V_{FB_}} \right) - 1 \right]$$

where $V_{FB_} = 1V$ (typ) (see the [Electrical Characteristics](#) table).

DC output accuracy specifications in the [Electrical Characteristics](#) table refer to the error comparator's threshold, $V_{FB_} = 1V$ (typ). When the inductor conducts continuously, the devices regulate the peak of the output ripple, so the actual DC output voltage is lower than the slope-compensated trip level by 50% of the output ripple voltage.

In discontinuous conduction mode (skip or STDBY active and $I_{OUT} < I_{LOAD(SKIP)}$), the devices regulate the valley of the output ripple, so the output voltage has a DC regulation level higher than the error-comparator threshold.

Inductor Selection in Buck Converters

Three key inductor parameters must be specified for operation with the MAX17232/MAX17233: inductance value (L), inductor saturation current (I_{SAT}), and DC resistance (R_{DCR}). To determine the optimum inductance, knowing the typical duty cycle (D) is important.

$$D = \frac{V_{OUT}}{V_{IN}} \text{ OR } D = \frac{V_{OUT}}{V_{IN} - I_{OUT}(R_{DS(ON)} + R_{DCR})}$$

if the R_{DCR} of the inductor and $R_{DS(ON)}$ of the MOSFET are available with $V_{IN} = (V_{BAT} - V_{DIODE})$. All values should be typical to optimize the design for normal operation.

Inductance

The exact inductor value is not critical and can be adjusted in order to make trade-offs among size, cost, efficiency, and transient response requirements.

- Lower inductor values increase LIR, which minimizes size and cost and improves transient response at the cost of reduced efficiency due to higher peak currents.
- Higher inductance values decrease LIR, which increases efficiency by reducing the RMS current at the cost of requiring larger output capacitors to meet load-transient specifications.

The ratio of the inductor peak-to-peak AC current to DC average current (LIR) must be selected first. A good initial value is a 30% peak-to-peak ripple current to average-current ratio (LIR = 0.3). The switching frequency, input voltage, output voltage, and selected LIR then determine the inductor value as follows:

$$L[\mu\text{H}] = \frac{(V_{IN} - V_{OUT}) \times D}{f_{SW}[\text{MHz}] \times I_{OUT} \times \text{LIR}}$$

where V_{IN} , V_{OUT} , and I_{OUT} are typical values (so that efficiency is optimum for typical conditions).

Peak Inductor Current

Inductors are rated for maximum saturation current. The maximum inductor current equals the maximum load current in addition to half of the peak-to-peak ripple current:

$$I_{PEAK} = I_{LOAD(MAX)} + \frac{\Delta I_{INDUCTOR}}{2}$$

For the selected inductance value, the actual peak-to-peak inductor ripple current ($\Delta I_{INDUCTOR}$) is calculated as:

$$\Delta I_{INDUCTOR} = \frac{V_{OUT}(V_{IN} - V_{OUT})}{V_{IN} \times f_{SW} \times L}$$

where $\Delta I_{INDUCTOR}$ is in mA, L is in µH, and f_{SW} is in kHz.

Once the peak current and the inductance are known, the inductor can be selected. The saturation current should be larger than I_{PEAK} or at least in a range where the inductance does not degrade significantly. The MOSFETs are required to handle the same range of current without dissipating too much power.

MOSFET Selection in Buck Converters

Each step-down controller drives two external logic-level n-channel MOSFETs as the circuit switch elements. The key selection parameters to choose these MOSFETs include the items in the following sections.

Threshold Voltage

All four n-channel MOSFETs must be a logic-level type with guaranteed on-resistance specifications at $V_{GS} = 4.5\text{V}$. If the internal regulator is bypassed (for example: $V_{EXTVCC} = 3.3\text{V}$), then the nMOSFETs should be chosen to have guaranteed on-resistance at that gate-to-source voltage.

Maximum Drain-to-Source Voltage ($V_{DS(MAX)}$)

All MOSFETs must be chosen with an appropriate V_{DS} rating to handle all V_{IN} voltage conditions.

Current Capability

The n-channel MOSFETs must deliver the average current to the load and the peak current during switching. Choose MOSFETs with the appropriate average current at $V_{GS} = 4.5V$ or $V_{GS} = V_{EXTVCC}$ when the internal linear regulator is bypassed. For load currents below approximately 3A, dual MOSFETs in a single package can be an economical solution. To reduce switching noise for smaller MOSFETs, use a series resistor in the BST_ path and additional gate capacitance.

Current-Sense Measurement

For the best current-sense accuracy and overcurrent protection, use a $\pm 1\%$ tolerance current-sense resistor

between the inductor and output as shown in [Figure 1a](#). This configuration constantly monitors the inductor current, allowing accurate current-limit protection. Use low-inductance current-sense resistors for accurate measurement.

Alternatively, high-power applications that do not require highly accurate current-limit protection can reduce the overall power dissipation by connecting a series RC circuit across the inductor ([Figure 1b](#)) with an equivalent time constant:

$$R_{CSHL} = \left(\frac{R_2}{R_1 + R_2} \right) R_{DCR}$$

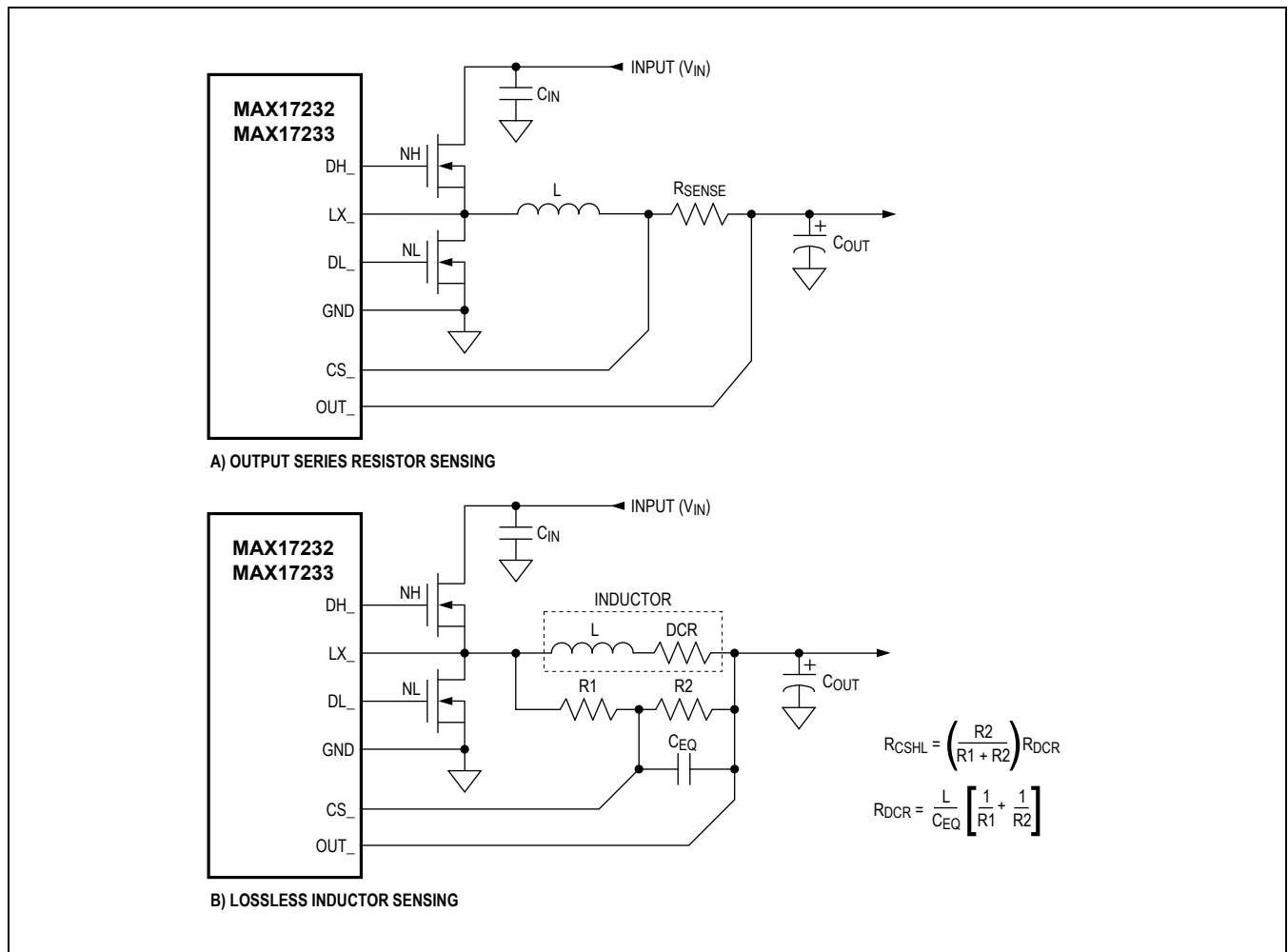

Figure 1. Current-Sense Configurations

and:

$$R_{DCR} = \frac{L}{C_{EQ}} \left(\frac{1}{R1} + \frac{1}{R2} \right)$$

where R_{CSHL} is the required current-sense resistor and R_{DCR} is the inductor's series DC resistor. Use the inductance and R_{DCR} values provided by the inductor manufacturer.

Carefully observe the PCB layout guidelines to ensure the noise and DC errors do not corrupt the differential current-sense signals seen by CS_ and OUT_. Place the sense resistor close to the devices with short, direct traces, making a Kelvin-sense connection to the current-sense resistor.

Input Capacitor in Buck Converters

The discontinuous input current of the buck converter causes large input ripple currents and therefore the input capacitor must be carefully chosen to withstand the input ripple current and keep the input voltage ripple within design requirements. The 180° ripple phase operation increases the frequency of the input capacitor ripple current to twice the individual converter switching frequency. When using ripple phasing, the worst-case input capacitor ripple current is when the converter with the highest output current is on.

The input voltage ripple is composed of ΔV_Q (caused by the capacitor discharge) and ΔV_{ESR} (caused by the ESR of the input capacitor). The total voltage ripple is the sum of ΔV_Q and ΔV_{ESR} that peaks at the end of an on-cycle. Calculate the input capacitance and ESR required for a specific ripple using the following equation:

$$ESR[\Omega] = \frac{\Delta V_{ESR}}{\left(I_{LOAD(MAX)} + \frac{\Delta I_{P-P}}{2} \right)}$$

$$C_{IN}[\mu F] = \frac{I_{LOAD(MAX)} \times \left(\frac{V_{OUT}}{V_{IN}} \right)}{(\Delta V_Q \times f_{SW})}$$

where:

$$\Delta I_{P-P} = \frac{(V_{IN} - V_{OUT}) \times V_{OUT}}{V_{IN} \times f_{SW} \times L}$$

$I_{LOAD(MAX)}$ is the maximum output current in A, ΔI_{P-P} is the peak-to-peak inductor current in A, f_{SW} is the switching frequency in MHz, and L is the inductor value in µH.

The internal 5V linear regulator (BIAS) includes an output UVLO with hysteresis to avoid unintentional chattering during turn-on. Use additional bulk capacitance if the input source impedance is high. At lower input voltage, additional input capacitance helps avoid possible undershoot below the undervoltage lockout threshold during transient loading.

Output Capacitor in Buck Converters

The actual capacitance value required relates to the physical size needed to achieve low ESR, as well as to the chemistry of the capacitor technology. The capacitor is usually selected by ESR and the voltage rating rather than by capacitance value.

When using low-capacity filter capacitors, such as ceramic capacitors, size is usually determined by the capacity needed to prevent V_{SAG} and V_{SOAR} from causing problems during load transients. Generally, once enough capacitance is added to meet the overshoot requirement, undershoot at the rising load edge is no longer a problem (see the [Transient Considerations](#) section). However, low-capacity filter capacitors typically have high-ESR zeros that can affect the overall stability.

The total voltage sag (V_{SAG}) can be calculated as follows:

$$V_{SAG} = \frac{L(\Delta I_{LOAD(MAX)})^2}{2C_{OUT}((V_{IN} \times D_{MAX}) - V_{OUT})} + \frac{\Delta I_{LOAD(MAX)}(t - \Delta t)}{C_{OUT}}$$

The amount of overshoot (V_{SOAR}) during a full-load to no-load transient due to stored inductor energy can be calculated as:

$$V_{SOAR} \approx \frac{(\Delta I_{LOAD(MAX)})^2 L}{2C_{OUT} V_{OUT}}$$

ESR Considerations

The output filter capacitor must have low enough equivalent series resistance (ESR) to meet output ripple and load-transient requirements, yet have high enough ESR to satisfy stability requirements. When using high-capacitance, low-ESR capacitors, the filter capacitor's ESR dominates the output voltage ripple. So the output capacitor's size depends on the maximum ESR required to meet the output-voltage ripple ($V_{RIPPLE(P-P)}$) specifications:

$$V_{RIPPLE(P-P)} = ESR \times I_{LOAD(MAX)} \times LIR$$

In standby mode, the inductor current becomes discontinuous, with peak currents set by the idle-mode current-sense threshold ($V_{CS,SKIP} = 26\text{mV}$ (typ)).

Transient Considerations

The output capacitor must be large enough to absorb the inductor energy while transitioning from no-load to full-load condition without tripping the overvoltage fault protection. The total output voltage sag is the sum of the voltage sag while the inductor is ramping up and the voltage sag before the next pulse can occur. Therefore:

$$C_{OUT} = \frac{L(\Delta I_{LOAD(MAX)})^2}{2V_{SAG}(V_{IN} \times D_{MAX} - V_{OUT})} + \frac{\Delta I_{LOAD(MAX)}(t - \Delta t)}{V_{SAG}}$$

where D_{MAX} is the maximum duty factor (approximately 95%), L is the inductor value in μH , C_{OUT} is the output capacitor value in μF , t is the switching period ($1/f_{SW}$) in μs , and Δt equals $(V_{OUT}/V_{IN}) \times t$.

The MAX17232/MAX17233 use a peak current-mode control scheme that regulates the output voltage by forcing the required current through the external inductor, so the controller uses the voltage drop across the DC resistance of the inductor or the alternate series current-sense resistor to measure the inductor current. Current-mode control eliminates the double pole in the feedback loop caused by the inductor and output capacitor resulting in a smaller phase shift and requiring less elaborate error-amplifier compensation than voltage-mode control. A single series resistor (R_C) and capacitor (C_C) is all that is required to have a stable, high-bandwidth loop in applications where ceramic capacitors are used for output filtering (see [Figure 2](#)). For other types of capacitors, due to the higher capacitance and ESR, the frequency of the zero created by the capacitance and ESR is lower than the desired closed-loop crossover frequency. To stabilize a non-ceramic output capacitor loop, add another compensation capacitor (C_F) from COMP to AGND to cancel this ESR zero.

The basic regulator loop is modeled as a power modulator, output feedback divider, and an error amplifier as shown in [Figure 2](#). The power modulator has a DC gain set by $g_{mc} \times R_{LOAD}$, with a pole and zero pair set by R_{LOAD} , the output capacitor (C_{OUT}), and its ESR. The loop response is set by the following equations:

$$GAIN_{MOD(dc)} = g_{mc} \times R_{LOAD}$$

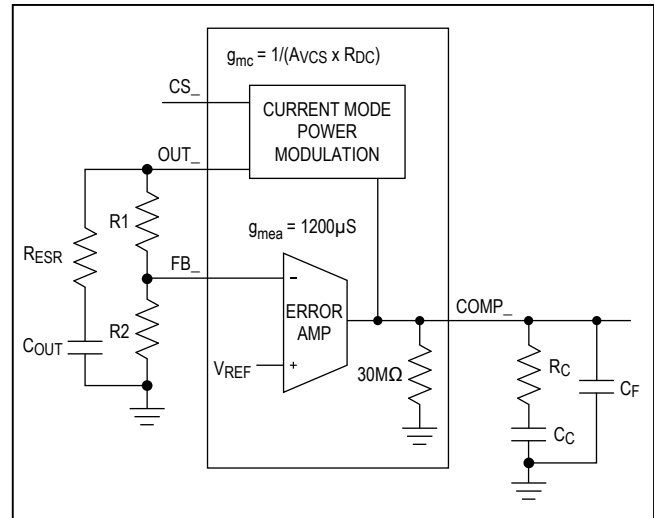

Figure 2. Compensation Network

where $R_{LOAD} = V_{OUT}/I_{LOAD(MAX)}$ in Ω and $g_{mc} = 1/(A_{V_CS} \times R_{DC})$ in S. A_{V_CS} is the voltage gain of the current-sense amplifier and is typically 11V/V. R_{DC} is the DC resistance of the inductor or the current-sense resistor in Ω .

In a current-mode step-down converter, the output capacitor and the load resistance introduce a pole at the following frequency:

$$f_{pMOD} = \frac{1}{2\pi \times C_{OUT} \times R_{LOAD}}$$

The unity gain frequency of the power stage is set by C_{OUT} and g_{mc} :

$$f_{UGAINpMOD} = \frac{g_{mc}}{2\pi \times C_{OUT}}$$

The output capacitor and its ESR also introduce a zero at:

$$f_{zMOD} = \frac{1}{2\pi \times ESR \times C_{OUT}}$$

When C_{OUT} is composed of “n” identical capacitors in parallel, the resulting $C_{OUT} = n \times C_{OUT(EACH)}$, and $ESR = ESR(EACH)/n$. Note that the capacitor zero for a parallel combination of alike capacitors is the same as for an individual capacitor.

The feedback voltage-divider has a gain of $GAIN_{FB} = V_{FB}/V_{OUT}$, where V_{FB} is 1V (typ).

The transconductance error amplifier has a DC gain of $GAIN_{EA(DC)} = g_{m,EA} \times R_{OUT,EA}$, where $g_{m,EA}$ is the error amplifier transconductance, which is 1200µS (typ), and $R_{OUT,EA}$ is the output resistance of the error amplifier, which is 30MΩ (typ) (see the [Electrical Characteristics](#) table.)

A dominant pole (f_{dpEA}) is set by the compensation capacitor (C_C) and the amplifier output resistance ($R_{OUT,EA}$). A zero (f_{zEA}) is set by the compensation resistor (R_C) and the compensation capacitor (C_C). There is an optional pole (f_{pEA}) set by C_F and R_C to cancel the output capacitor ESR zero if it occurs near the crossover frequency (f_C , where the loop gain equals 1 (0dB)). Thus:

$$f_{dpEA} = \frac{1}{2\pi \times C_C \times (R_{OUT,EA} + R_C)}$$

$$f_{zEA} = \frac{1}{2\pi \times C_C \times R_C}$$

$$f_{pEA} = \frac{1}{2\pi \times C_F \times R_C}$$

The loop-gain crossover frequency (f_C) should be set below 1/5th of the switching frequency and much higher than the power-modulator pole (f_{pMOD}). Select a value for f_C in the range:

$$f_{pMOD} \ll f_C \leq \frac{f_{SW}}{5}$$

At the crossover frequency, the total loop gain must be equal to 1. So:

$$GAIN_{MOD}(f_C) \times \frac{V_{FB}}{V_{OUT}} \times GAIN_{EA}(f_C) = 1$$

$$GAIN_{EA}(f_C) = g_{m,EA} \times R_C$$

$$GAIN_{MOD}(f_C) = GAIN_{MOD}(dc) \times \frac{f_{pMOD}}{f_C}$$

Therefore:

$$GAIN_{MOD}(f_C) \times \frac{V_{FB}}{V_{OUT}} \times g_{m,EA} \times R_C = 1$$

Solving for R_C :

$$R_C = \frac{V_{OUT}}{g_{m,EA} \times V_{FB} \times GAIN_{MOD}(f_C)}$$

Set the error-amplifier compensation zero formed by R_C and C_C at the f_{pMOD} . Calculate the value of C_C as follows:

$$C_C = \frac{1}{2\pi \times f_{pMOD} \times R_C}$$

If f_{zMOD} is less than $5 \times f_C$, add a second capacitor C_F from COMP to AGND. The value of C_F is:

$$C_F = \frac{1}{2\pi \times f_{zMOD} \times R_C}$$

As the load current decreases, the modulator pole also decreases; however, the modulator gain increases accordingly and the crossover frequency remains the same.

Below is a numerical example to calculate the compensation network component values of [Figure 2](#):

$$A_{V_CS} = 11V/V$$

$$R_{DCR} = 15m\Omega$$

$$g_{mc} = 1/(A_{V_CS} \times R_{DC}) = 1/(11 \times 0.015) = 6.06$$

$$V_{OUT} = 5V$$

$$I_{OUT(MAX)} = 5.33A$$

$$R_{LOAD} = V_{OUT}/I_{OUT(MAX)} = 5V/5.33A = 0.9375\Omega$$

$$C_{OUT} = 2 \times 47\mu F = 94\mu F$$

$$ESR = 9m\Omega/2 = 4.5m\Omega$$

$$f_{SW} = 26.4/65.5k\Omega = 0.403MHz$$

$$GAIN_{MOD}(dc) = 6.06 \times 0.9375 = 5.68$$

$$f_{pMOD} = \frac{1}{2\pi \times 94\mu F \times 0.9375} \approx 1.8kHz$$

$$f_{pMOD} \ll f_C \leq \frac{f_{SW}}{5}$$

$$1.8kHz \ll f_C \leq 80.6kHz$$

select $f_C = 40kHz$

$$f_{zMOD} = \frac{1}{2\pi \times 4.5m\Omega \times 94\mu F} \approx 376kHz$$

since $f_{zMOD} > f_C$:

$$R_C \approx 16k\Omega$$

$$C_C \approx 5.6nF$$

$$C_F \approx 27pF$$

Applications Information

Layout Recommendations

Careful PCB layout is critical to achieve low switching losses and clean, stable operation. The switching power stage requires particular attention (Figure 3). If possible, mount all the power components on the top side of the board, with their ground terminals flush against one another. Follow these guidelines for good PCB layout:

- Keep the high-current paths short, especially at the ground terminals. This practice is essential for stable, jitter-free operation.
- Keep the power traces and load connections short. This practice is essential for high efficiency. Using thick copper PCBs (2oz vs. 1oz) can enhance full load efficiency by 1% or more.
- Minimize current-sensing errors by connecting CS₋ and OUT₋. Use kelvin sensing directly across the current-sense resistor (R_{SENSE-}).
- Route high-speed switching nodes (BST₋, LX₋, DH₋, and DL₋) away from sensitive analog areas (FB₋, CS₋, and OUT₋).

Layout Procedure

- 1) Place the power components first, with ground terminals adjacent (low-side FET, C_{IN}, C_{OUT-}, and Schottky). If possible, make all these connections on the top layer with wide, copper-filled areas.

- 2) Mount the controller IC adjacent to the low-side MOSFET, preferably on the back side opposite NL₋ and NH₋ to keep LX₋, GND, DH₋, and the DL₋ gate drive lines short and wide. The DL₋ and DH₋ gate traces must be short and wide (50 mils to 100 mils wide if the MOSFET is 1in from the controller IC) to keep the driver impedance low and for proper adaptive dead-time sensing.
- 3) Group the gate-drive components (BST₋ diode and capacitor and LDO bypass capacitor BIAS) together near the controller IC. Be aware that gate currents of up to 1A flow from the bootstrap capacitor to BST₋, from DH₋ to the gate of the external HS switch and from the LX₋ pin to the inductor. Up to 100mA of current flow from the BIAS capacitor through the bootstrap diode to the bootstrap capacitor. Dimension those traces accordingly.
- 4) Make the DC-DC controller ground connections as shown in Figure 3. This diagram can be viewed as having two separate ground planes: power ground, where all the high-power components go; and an analog ground plane for sensitive analog components. The analog ground plane and power ground plane must meet only at a single point directly under the IC.
- 5) Connect the output power planes directly to the output filter capacitor positive and negative terminals with multiple vias. Place the entire DC-DC converter circuit as close to the load as is practical.

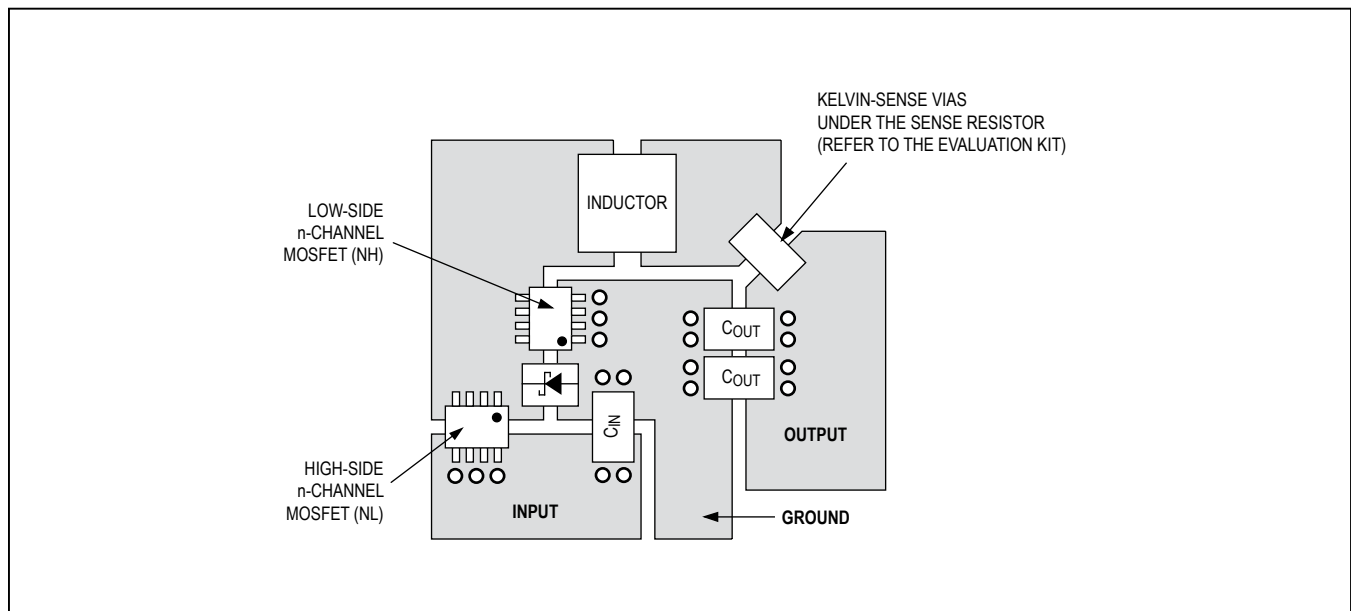
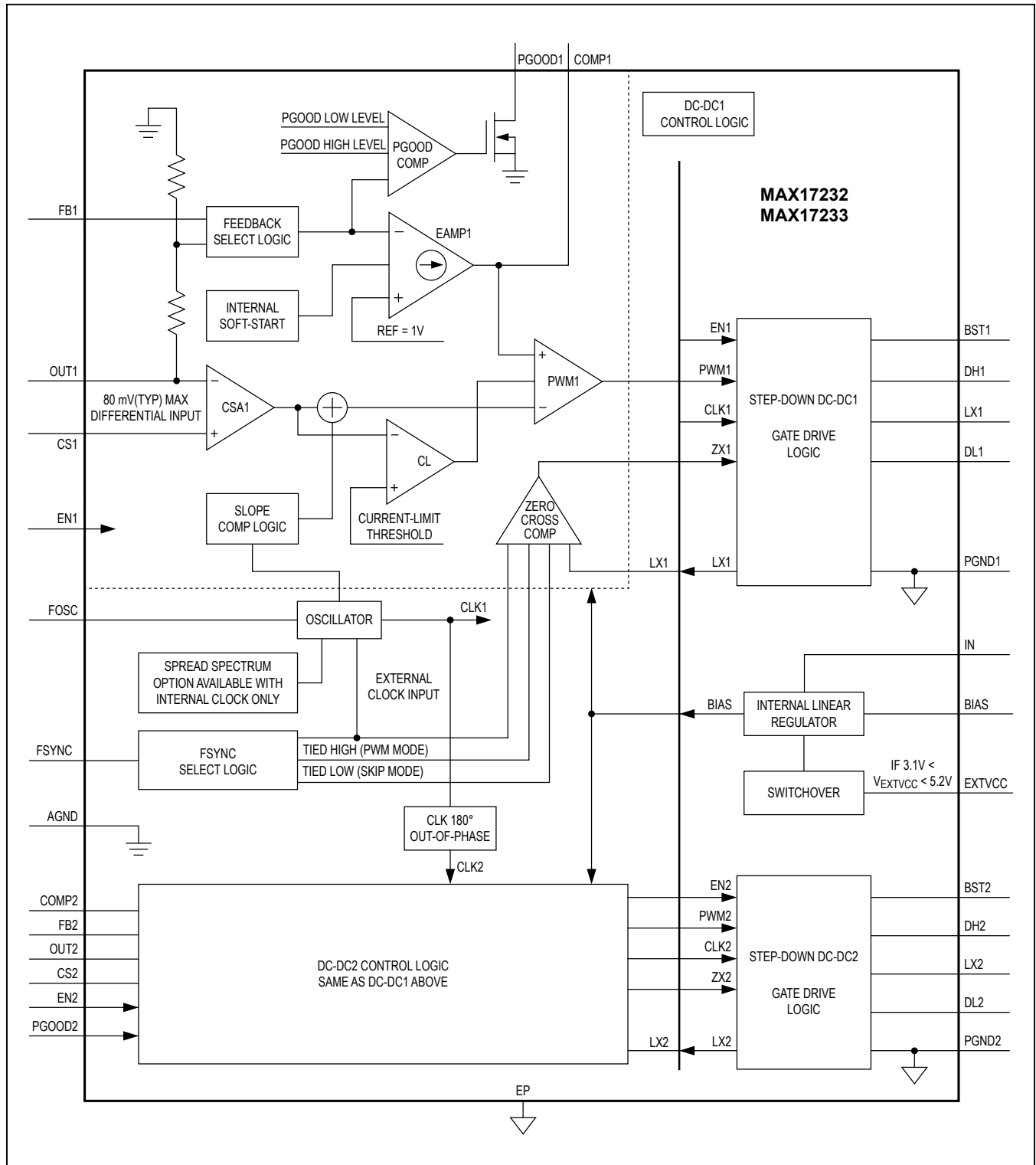

Figure 3. Layout Example

Block Diagram



Selector Guide

PART	BUCK 1 SWITCHING FREQUENCY (f _{SW1})	BUCK 2 SWITCHING FREQUENCY (f _{SW2})	SPREAD SPECTRUM (%)
MAX17233ETIR+	1MHz to 2.2MHz	f _{SW1}	—
MAX17233ETIS+	1MHz to 2.2MHz	f _{SW1}	6
MAX17232ETIR+	200kHz to 1MHz	f _{SW1}	—
MAX17232ETIS+	200kHz to 1MHz	f _{SW1}	6

Ordering Information

PART	TEMP RANGE	PIN-PACKAGE
MAX17233ETI_+	-40°C to +85°C	28 TQFN-EP*
MAX17232ETI_+	-40°C to +85°C	28 TQFN-EP*

Note: Insert the desired suffix letter (from [Selector Guide](#)) into the blank to indicate buck 2 switching frequency and spread spectrum.

+Denotes a lead(Pb)-free/RoHS-compliant package.

*EP = Exposed pad.

Package Information

For the latest package outline information and land patterns (footprints), go to www.maximintegrated.com/packages. Note that a "+", "#", or "-" in the package code indicates RoHS status only. Package drawings may show a different suffix character, but the drawing pertains to the package regardless of RoHS status.

PACKAGE TYPE	PACKAGE CODE	OUTLINE NO.	LAND PATTERN NO.
28 TQFN-EP	T2855+5	21-0140	90-0025

Chip Information

PROCESS: BICMOS

Revision History

REVISION NUMBER	REVISION DATE	DESCRIPTION	PAGES CHANGED
0	2/16	Initial release	—

For pricing, delivery, and ordering information, please contact Maxim Direct at 1-888-629-4642, or visit Maxim Integrated's website at www.maximintegrated.com.

Maxim Integrated cannot assume responsibility for use of any circuitry other than circuitry entirely embodied in a Maxim Integrated product. No circuit patent licenses are implied. Maxim Integrated reserves the right to change the circuitry and specifications without notice at any time. The parametric values (min and max limits) shown in the Electrical Characteristics table are guaranteed. Other parametric values quoted in this data sheet are provided for guidance.