

SOT-23-3L Plastic-Encapsulate MOSFET

P -Channel MOSFET

Product Summary

$V_{(BR)DSS}$	$R_{DS(on)MAX}$	I_D
-30V	60 mΩ@-10V	-4.2A
	70 mΩ@-4.5V	
	85 mΩ@-2.5V	

Features

- High dense cell design for extremely low $R_{DS(ON)}$
- Exceptional on-resistance and maximum DC current capability

Applications

- Load/Power Switching
- Interfacing Switching

Marking:

- R1A

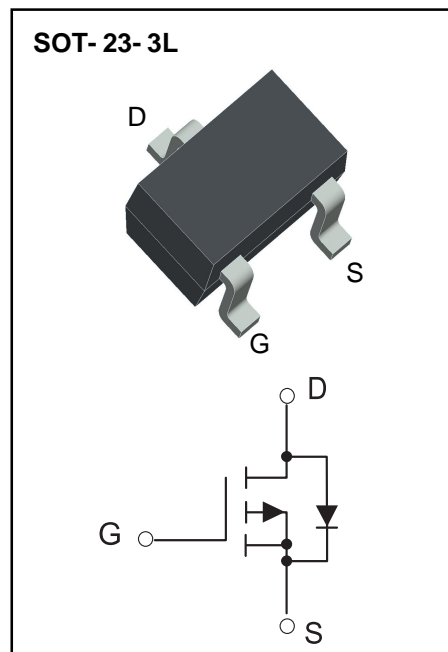

Limiting Values (Absolute Maximum Rating)

Parameter	Symbol	Value	Unit
Drain-Source Voltage	V_{DS}	-30	V
Gate-Source Voltage	V_{GS}	±12	V
Continuous Drain Current	I_D	-4.2	A
Power Dissipation	P_D	450	mW
Thermal Resistance from Junction to Ambient ($t < 5s$)	$R_{\theta JA}$	313	°C/W
Junction Temperature	T_J	150	°C
Storage Temperature	T_{STG}	-55~+150	°C

Electrical Characteristics ($T_A=25^\circ\text{C}$ unless otherwise noted)

Parameter	Symbol	Test Condition	Min	Typ	Max	Unit
Off characteristics						
Drain-source breakdown voltage	$V_{(BR)DSS}$	$V_{GS} = 0V, I_D = -250\mu A$	-30			V
Zero gate voltage drain current	I_{DSS}	$V_{DS} = -24V, V_{GS} = 0V$			-1	μA
Gate-source leakage current	I_{GSS}	$V_{GS} = \pm 12V, V_{DS} = 0V$			± 100	nA
On characteristics						
Drain-source on-resistance (note 1)	$R_{DS(on)}$	$V_{GS} = -10V, I_D = -4.2A$			60	m Ω
		$V_{GS} = -4.5V, I_D = -4A$			70	m Ω
		$V_{GS} = -2.5V, I_D = -1A$			85	m Ω
Forward tranconductance (note 1)	g_{FS}	$V_{DS} = -5V, I_D = -5A$	7			S
Gate threshold voltage	$V_{GS(th)}$	$V_{DS} = V_{GS}, I_D = -250\mu A$	-0.7		-1.3	V
Dynamic characteristics (note 2)						
Input capacitance	C_{iss}	$V_{DS} = -15V, V_{GS} = 0V, f = 1MHz$		1050		pF
Output capacitance	C_{oss}			127		pF
Reverse transfer capacitance	C_{rss}			85		pF
Switching characteristics (note 2)						
Turn-on delay time	$t_{d(on)}$	$V_{GS} = -10V, V_{DS} = -15V,$ $R_L = 3.6\Omega, R_{GEN} = 6\Omega$			6.5	ns
Turn-on rise time	t_r				3.5	ns
Turn-off delay time	$t_{d(off)}$				40	ns
Turn-off fall Time	t_f				13	ns
Drain-source diode characteristics and maximum ratings						
Diode forward voltage (note 1)	V_{SD}	$I_S = -1A, V_{GS} = 0V$			-1	V

Note :

1. Pulse Test : Pulse width $\leq 300\mu s$, duty cycles $\leq 2\%$.
2. These parameters have no way to verify.

Typical Characteristics

Output Characteristics

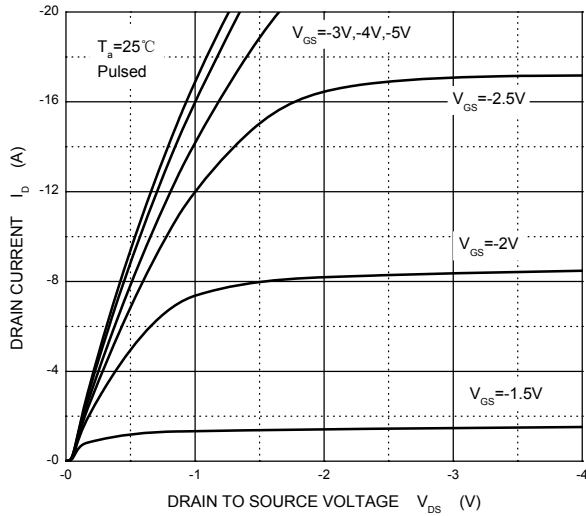

Transfer Characteristics

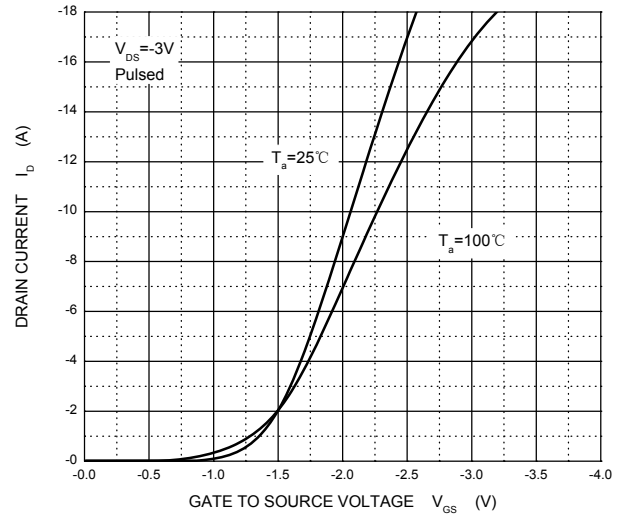

$R_{DS(ON)}$ — I_D

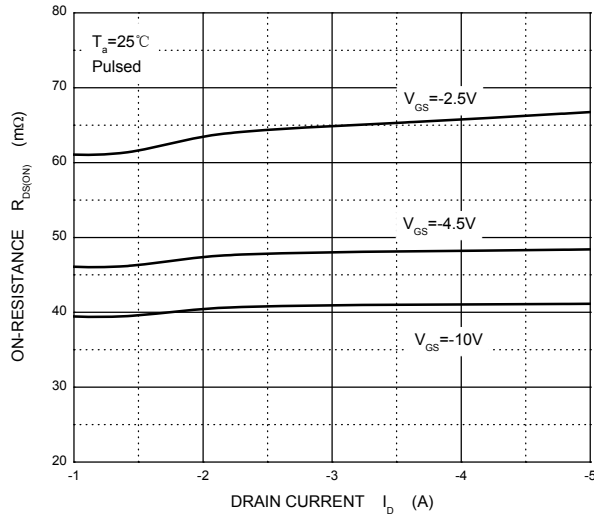

$R_{DS(ON)}$ — V_{GS}

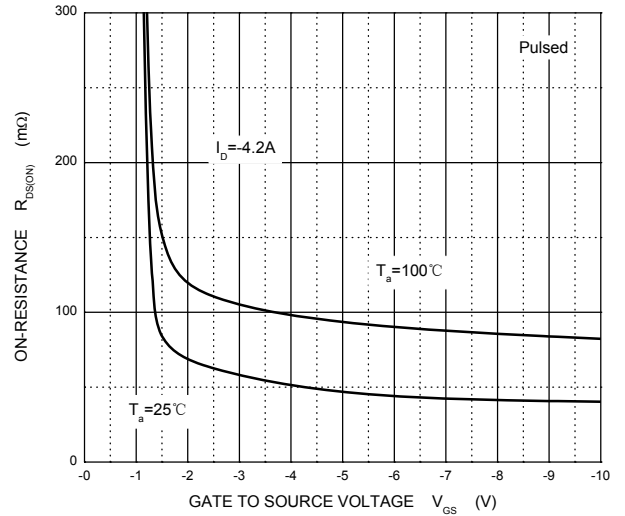

I_S — V_{SD}

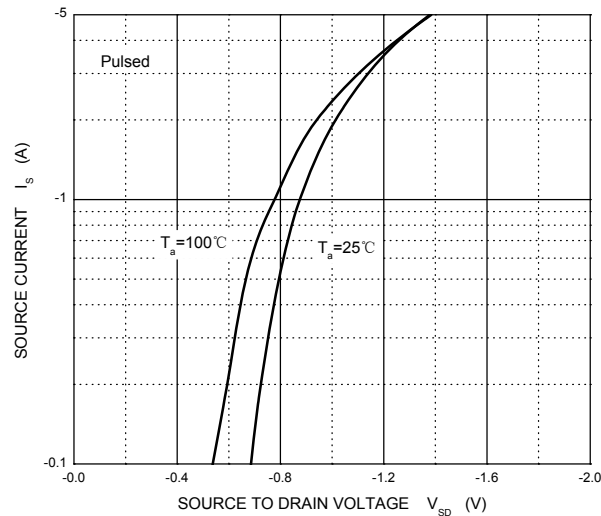

Threshold Voltage

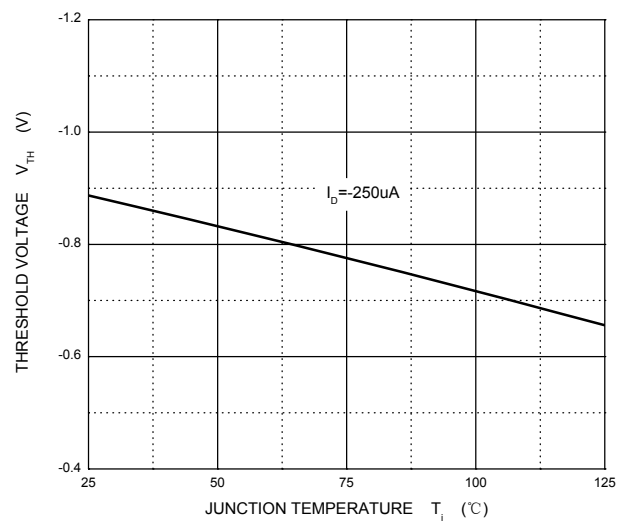

SOT-23-3L Package Outline Dimensions

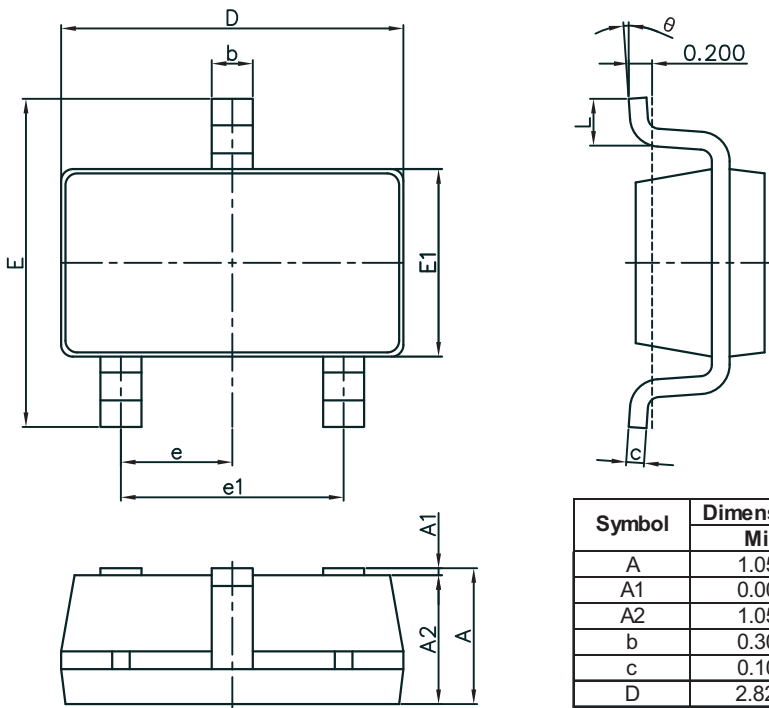

Symbol	Dimensions In Millimeters		Dimensions In Inches	
	Min.	Max.	Min.	Max.
A	1.050	1.250	0.041	0.049
A1	0.000	0.100	0.000	0.004
A2	1.050	1.150	0.041	0.045
b	0.300	0.500	0.012	0.020
c	0.100	0.200	0.004	0.008
D	2.820	3.020	0.111	0.119
E1	1.500	1.700	0.059	0.067
E	2.650	2.950	0.104	0.116
e	0.950(BSC)		0.037(BSC)	
e1	1.800	2.000	0.071	0.079
L	0.300	0.600	0.012	0.024
θ	0°	8°	0°	8°

SOT-23-3L Suggested Pad Layout

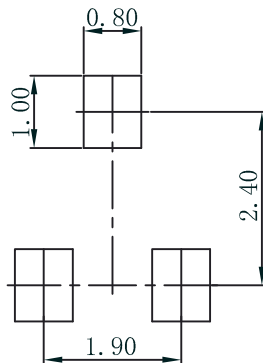

Note:

1. Controlling dimension: in millimeters.
2. General tolerance: $\pm 0.05\text{mm}$.
3. The pad layout is for reference purposes only.

NOTICE

JSHD reserve the right to make modifications, enhancements, improvements, corrections or other changes without further notice to any product herein. JSHD does not assume any liability arising out of the application or use of any product described herein.

Reel Taping Specifications For Surface Mount Devices-SOT-23-3L

SOT-23-3L Embossed Carrier Tape

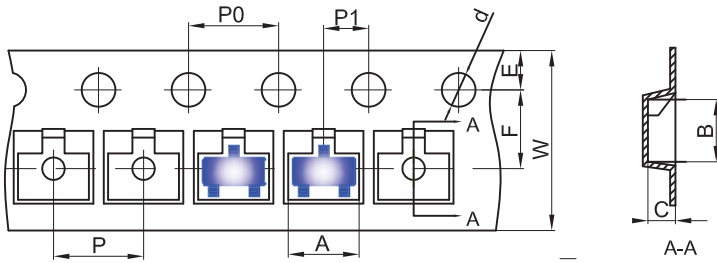

Packaging Description:

SOT-23-3L parts are shipped in tape. The carrier tape is made from a dissipative (carbon filled) polycarbonate resin. The cover tape is a multilayer film (Heat Activated Adhesive in nature) primarily composed of polyester film, adhesive layer, sealant, and anti-static sprayed agent. These reeled parts in standard option are shipped with 3,000 units per 7" or 18.0cm diameter reel. The reels are clear in color and is made of polystyrene plastic (anti-static coated).

Dimensions are in millimeter										
Pkg type	A	B	C	d	E	F	P0	P	P1	W
SOT-23-3L	3.18	3.28	1.32	Ø1.50	1.75	3.50	4.00	4.00	2.00	8.00

SOT-23-3L Tape Leader and Trailer

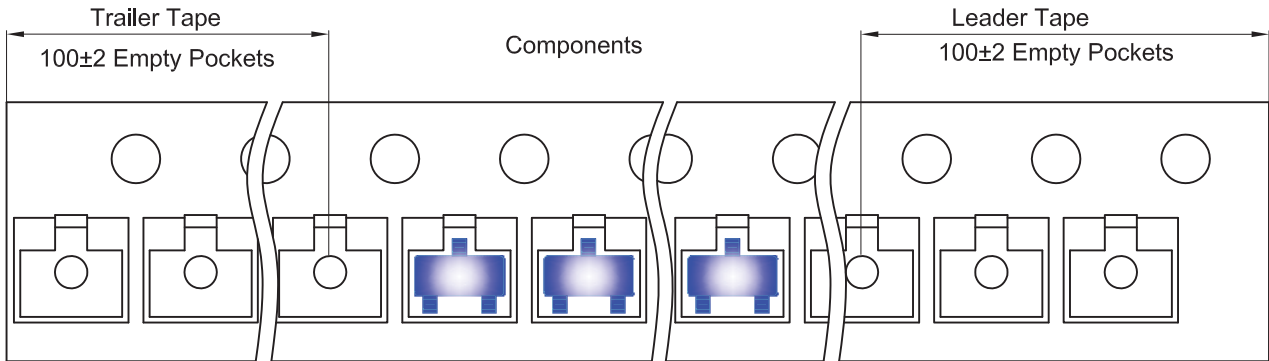

SOT-23-3L Reel

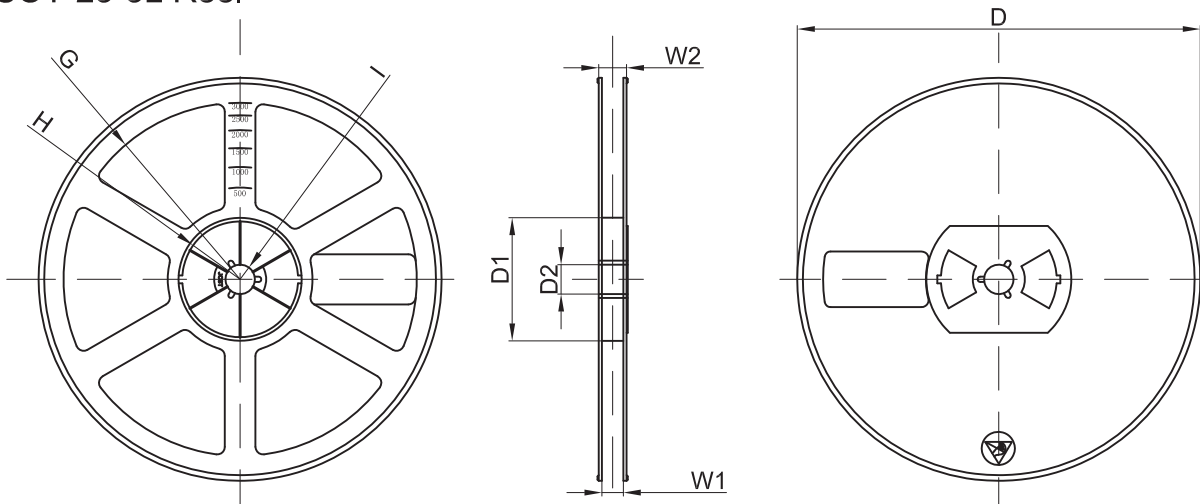

Dimensions are in millimeter								
Reel Option	D	D1	D2	G	H	I	W1	W2
7" Dia	Ø180.00	60.00	13.00	R78.00	R25.60	R6.50	9.50	13.10

REEL	Reel Size	Box	Box Size(mm)	Carton	Carton Size(mm)	G.W.(kg)
3000 pcs	7 inch	30,000 pcs	203×203×195	120,000 pcs	438×438×220	