

Industrial waterproof rectangular connector

DK-2 Series (12 Pin) Type

DDK Ltd.

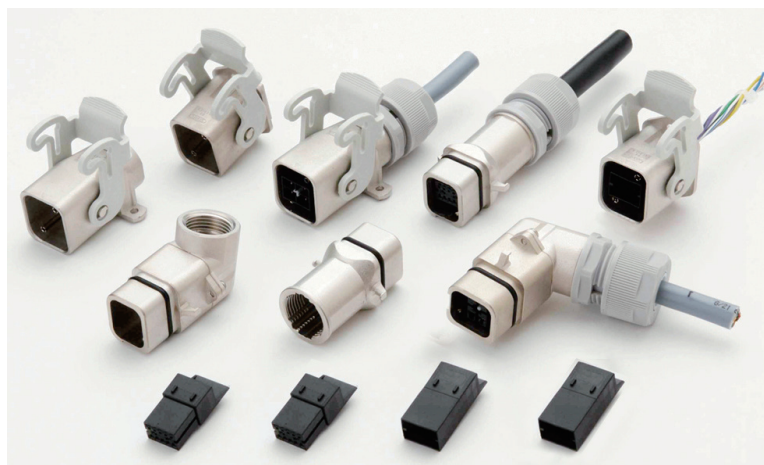

OUTLINE

- ◆ Waterproof rectangular connector was developed for connecting industrial equipment.
- ◆ Crimp termination contacts are the same as those of DK-2000 series.
- ◆ Tab and a receptacle housing are being prepared for the shell shape of the plug, the cable receptacle and the receptacle.
- ◆ DK-2 has one touch locking lever mechanism and a locking supporting system.
Pushing contacts in the direction of the mating half makes the connectors automatically and temporarily locked and you can mate the connectors easily.

APPLICATIONS

FA equipment (internal and external), robots, servo motors, medical equipment, communication equipment, OA equipment, various other electrical equipment

SPECIFICATIONS

Item	DK-2 Series
Rated Voltage	250V AC (r.m.s.)
Rated Current	5A max. / Contact
Dielectric Withstanding Voltage	1,500V AC (r.m.s.) / 1 minute
Insulation Resistance	1,000M Ω min. at 500V DC
Contact Resistance	10m Ω max.
Contact Pitch	3.5mm
Applicable Cable Size	AWG#18 – #28
Waterproof Rating	IP67
Number of Contacts	12 Pin

SAFETY STANDARD



Type Approved
Safety
Regular Production
Surveillance

www.tuv.com
ID 2000000000

MATERIALS / FINISHS



Item	Materials / Finishes
Contact	Copper Alloy / Au over Ni Plating
Housing	PBT Resin (UL94V-0) / Black
Shell / Hood	Aluminum Alloy and Zinc Alloy

© Specifications and/or dimensions in this catalogue are subject to change without notice.
Your catalogue checking the latest specifications with our drawings would be highly appreciated.

▶ 12 Pin Waterproof Connectors

Straight Plug

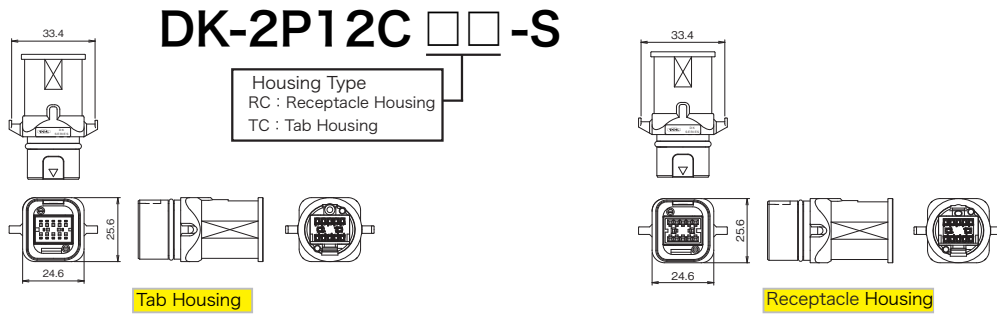

Right Angle Plug

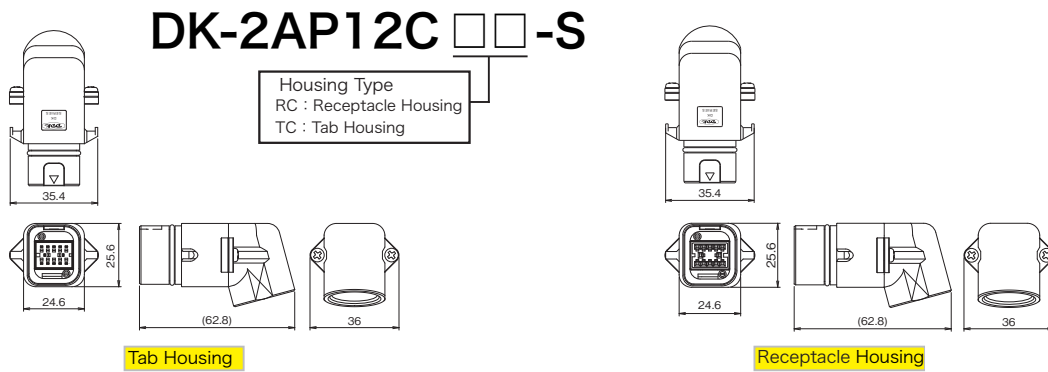

Cable Receptacle

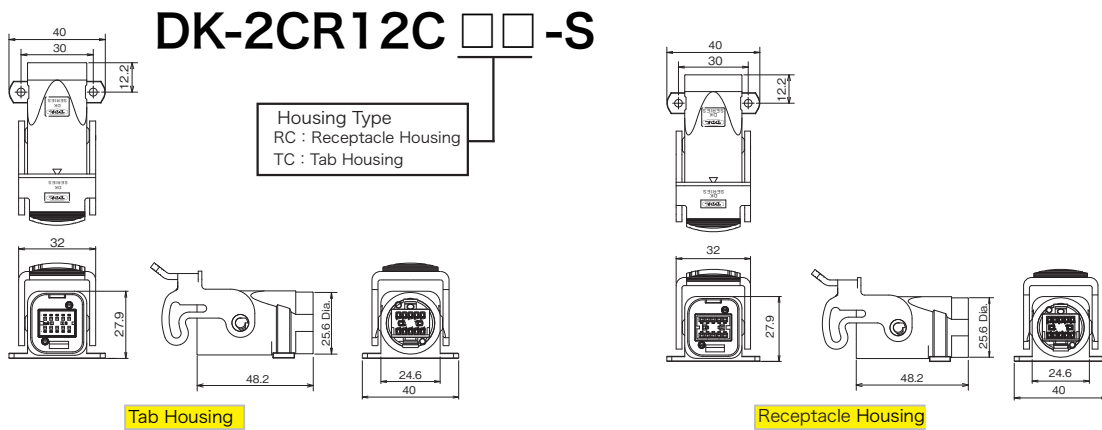

Box Receptacle

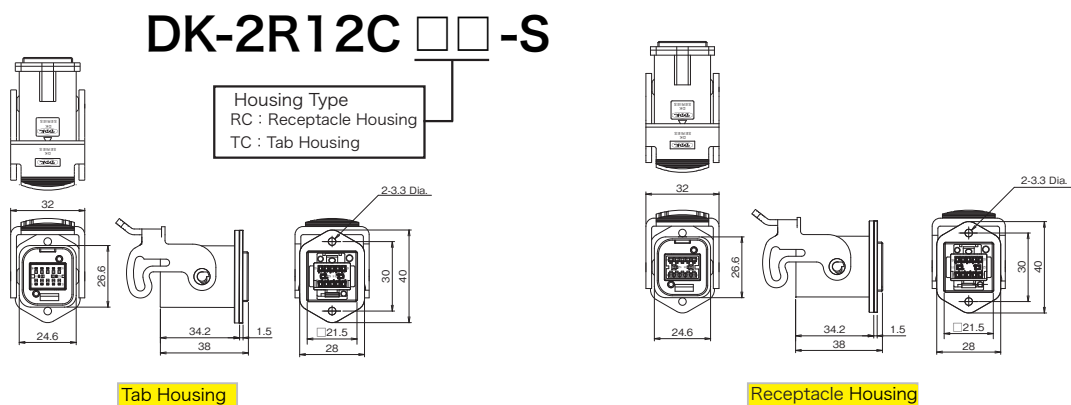

© Specifications and/or dimensions in this catalogue are subject to change without notice.
Your catalogue checking the latest specifications with our drawings would be highly appreciated.

▶ Crimp Contacts

DK-2 Contact

【Contact】

Applicable Cable Size		Insulation O.D. (mm)	Contact Size	Package Style	Part Number		Contact Quantity (pcs)
AWG	mm ²				Receptacle Contact	Tab Contact	
28	0.08	0.88 ~ 1.50	S	Reel	DK-2RECSST1-6000	DK-2TABSST1-6000	6,000
26	0.12				DK-2RECSLP1-100	DK-2TABSLP1-100	100
24	0.20			1.11 ~ 2.0	M	Reel	DK-2RECMST1-6000
20	0.50	DK-2RECMLP1-100	DK-2TABMLP1-100				100
18	0.80						

【Premating Contact】

Applicable Cable Size		Insulation O.D. (mm)	Contact Size	Package Style	Part Number		Contact Quantity (pcs)
AWG	mm ²				Receptacle Contact	Tab Contact	
28	0.08	0.88 ~ 1.50	S	Reel	DK-2RECSST1-E-6000	DK-2TABSST1-E-6000	6,000
26	0.12				DK-2RECSLP1-E-100	DK-2TABSLP1-E-100	100
24	0.20			1.11 ~ 2.0	M	Reel	DK-2RECMST1-E-6000
20	0.50	DK-2RECMLP1-E-100	DK-2TABMLP1-E-100				100
18	0.80						

DK-2RECSST1-E-6000

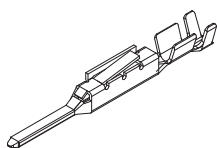
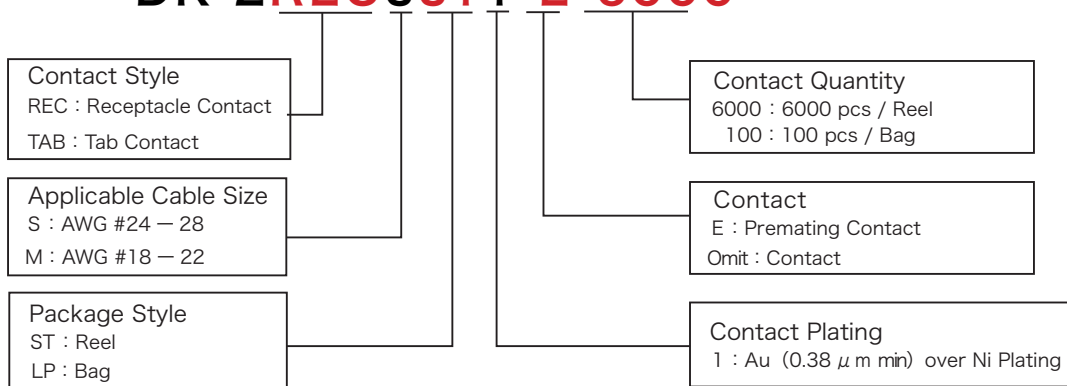

■ Tab Contact

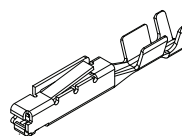

■ Receptacle Contact