

### Features

- 30V/55A,  
 $R_{DS(ON)} = 7\text{ m}\Omega$  (Typ.)@ $V_{GS} = 10\text{V}$   
 $R_{DS(ON)} = 12\text{ m}\Omega$  (Typ.)@ $V_{GS} = 4.5\text{V}$
- Super High Dense Cell Design
- Ultra Low On-Resistance
- 100% avalanche tested
- Lead Free and Green Devices Available  
 (RoHS Compliant)

### Applications

- DC-DC Converters

### Pin Description

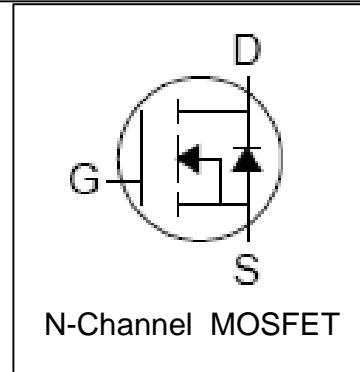
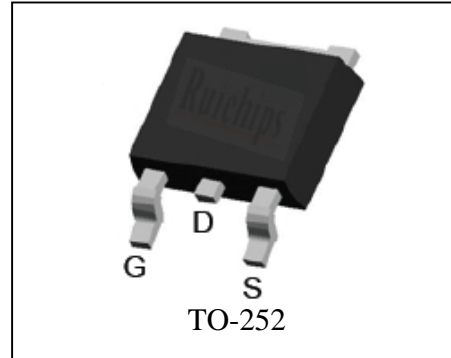

### Absolute Maximum Ratings

Symbol	Parameter	Rating	Unit
<b>Common Ratings</b> ( $T_C = 25^\circ\text{C}$ Unless Otherwise Noted)			
$V_{DSS}$	Drain-Source Voltage	30	V
$V_{GSS}$	Gate-Source Voltage	$\pm 20$	
$T_J$	Maximum Junction Temperature	175	$^\circ\text{C}$
$T_{STG}$	Storage Temperature Range	-55 to 175	$^\circ\text{C}$
$I_S$	Diode Continuous Forward Current	$T_C = 25^\circ\text{C}$ 55	A
<b>Mounted on Large Heat Sink</b>			
$I_{DP}$	300 $\mu\text{s}$ Pulse Drain Current Tested	$T_C = 25^\circ\text{C}$ 200 <sup>①</sup>	A
$I_D$	Continuous Drain Current ( $V_{GS} = 10\text{V}$ )	$T_C = 25^\circ\text{C}$ 55	A
		$T_C = 100^\circ\text{C}$ 37	
$P_D$	Maximum Power Dissipation	$T_C = 25^\circ\text{C}$ 50	W
		$T_C = 100^\circ\text{C}$ 25	W
$R_{\theta JC}$	Thermal Resistance-Junction to Case	3	$^\circ\text{C/W}$
<b>Drain-Source Avalanche Ratings</b>			
$E_{AS}$ <sup>②</sup>	Avalanche Energy, Single Pulsed	81	mJ

**Electrical Characteristics** ( $T_C=25^\circ\text{C}$  Unless Otherwise Noted)

Symbol	Parameter	Test Condition	RU3050L			Unit
			Min.	Typ.	Max.	
<b>Static Characteristics</b>						
$BV_{DSS}$	Drain-Source Breakdown Voltage	$V_{GS}=0V, I_{DS}=250\mu A$	30			V
$I_{DSS}$	Zero Gate Voltage Drain Current	$V_{DS}=30V, V_{GS}=0V$			1	$\mu A$
		$T_J=85^\circ C$			30	
$V_{GS(th)}$	Gate Threshold Voltage	$V_{DS}=V_{GS}, I_{DS}=250\mu A$	1	-	3	V
$I_{GSS}$	Gate Leakage Current	$V_{GS}=\pm 20V, V_{DS}=0V$			$\pm 100$	nA
$R_{DS(ON)}^{(3)}$	Drain-Source On-state Resistance	$V_{GS}=10V, I_{DS}=50A$		7	9	$m\Omega$
		$V_{GS}=4.5V, I_{DS}=35A$		12	16	$m\Omega$
<b>Diode Characteristics</b>						
$V_{SD}^{(3)}$	Diode Forward Voltage	$I_{SD}=50A, V_{GS}=0V$			1.2	V
$t_{rr}$	Reverse Recovery Time	$I_{SD}=50A, dI_{SD}/dt=100A/\mu s$		25		ns
$Q_{rr}$	Reverse Recovery Charge			16		nC
<b>Dynamic Characteristics</b> <sup>(4)</sup>						
$R_G$	Gate Resistance	$V_{GS}=0V, V_{DS}=0V, F=1MHz$		1.5		$\Omega$
$C_{iss}$	Input Capacitance	$V_{GS}=0V,$ $V_{DS}=15V,$ Frequency=1.0MHz		2630		pF
$C_{oss}$	Output Capacitance			510		
$C_{rss}$	Reverse Transfer Capacitance			230		
$t_{d(ON)}$	Turn-on Delay Time	$V_{DD}=15V, R_L=0.3\Omega,$ $I_{DS}=50A, V_{GEN}=10V,$ $R_G=5\Omega$		14		ns
$t_r$	Turn-on Rise Time			65		
$t_{d(OFF)}$	Turn-off Delay Time			34		
$t_f$	Turn-off Fall Time			29		
<b>Gate Charge Characteristics</b> <sup>(4)</sup>						
$Q_g$	Total Gate Charge	$V_{DS}=24V, V_{GS}=10V,$ $I_{DS}=50A$		40		nC
$Q_{gs}$	Gate-Source Charge			8		
$Q_{gd}$	Gate-Drain Charge			12		

- Notes: ① Pulse width limited by safe operating area.  
 ② Limited by  $T_{Jmax}, I_{AS}=18A, V_{DD}=24V, R_G=50\Omega$ , Starting  $T_J=25^\circ C$ .  
 ③ Pulse test; Pulse width  $\leq 300\mu s$ , duty cycle  $\leq 2\%$ .  
 ④ Guaranteed by design, not subject to production testing.

**Typical Characteristics**

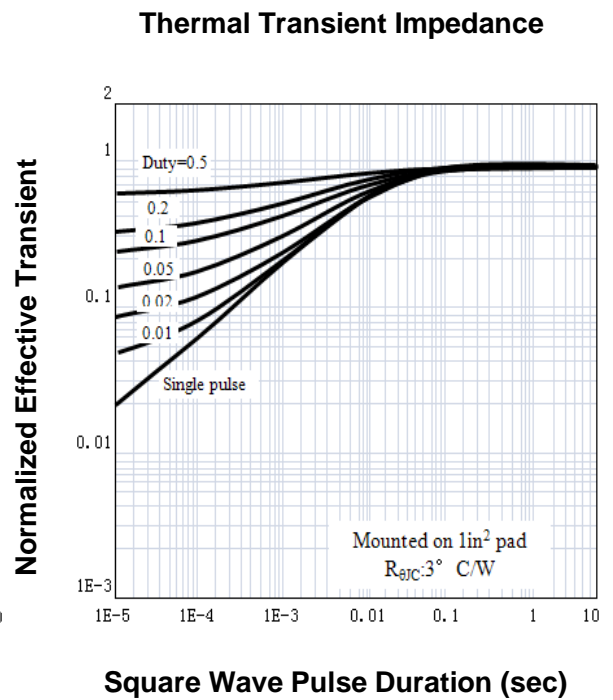
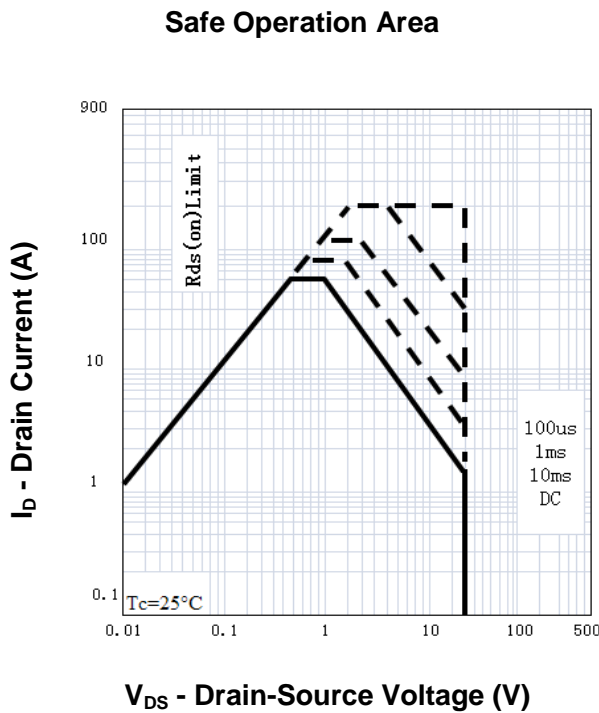
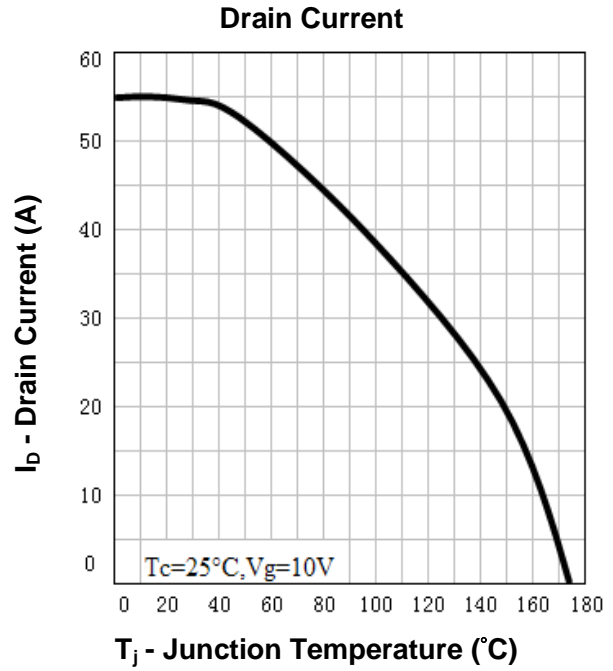
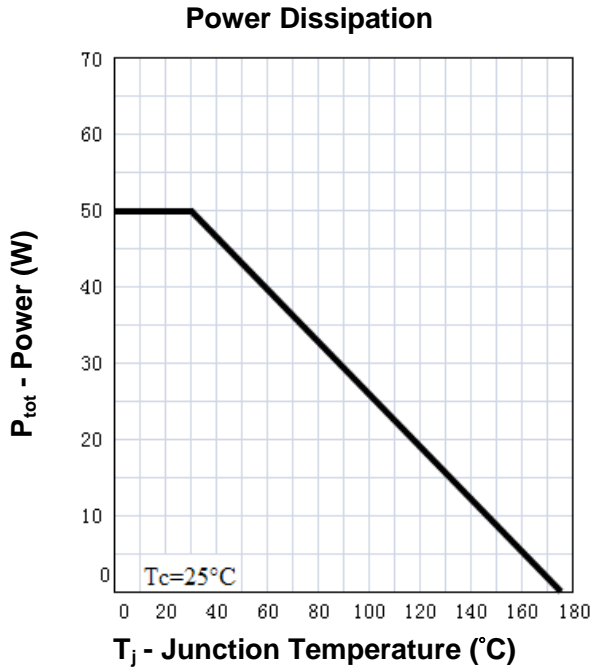

**Typical Characteristics**

**Output Characteristics**

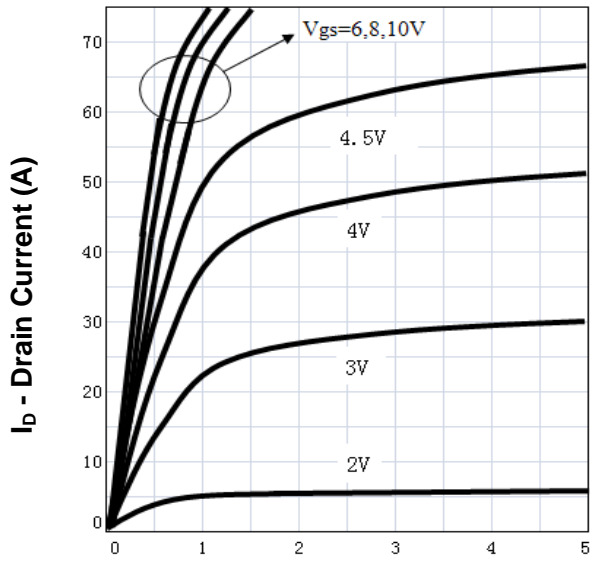

$V_{DS}$  - Drain-Source Voltage (V)

**Drain-Source On Resistance**

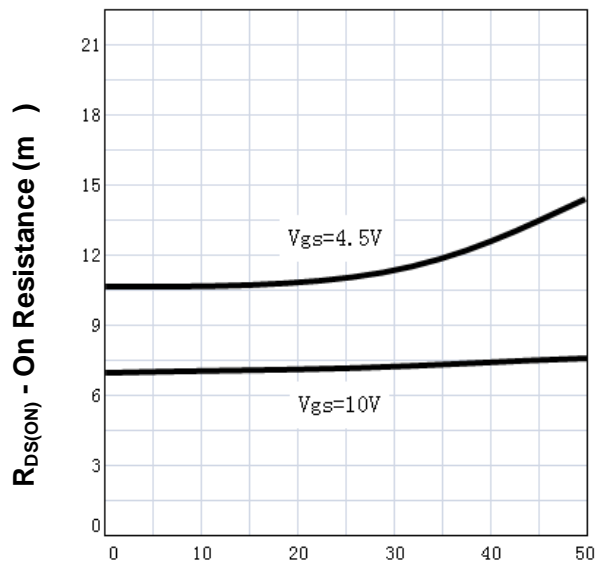

$I_D$  - Drain Current (A)

**Drain-Source On Resistance**

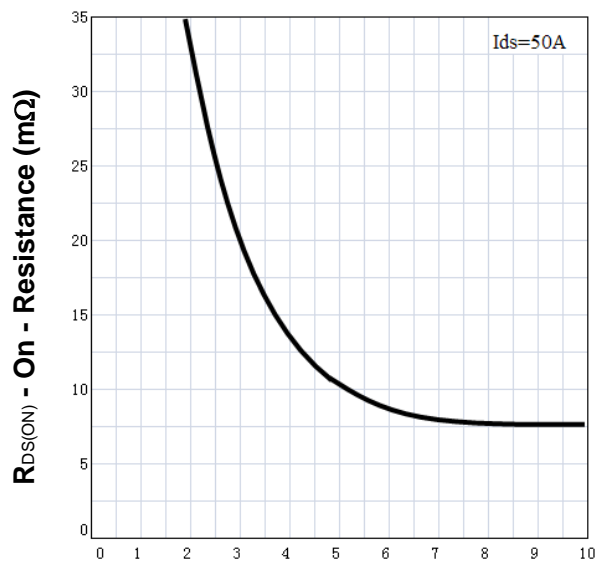

$V_{GS}$  - Gate-Source Voltage (V)

**Gate Threshold Voltage**

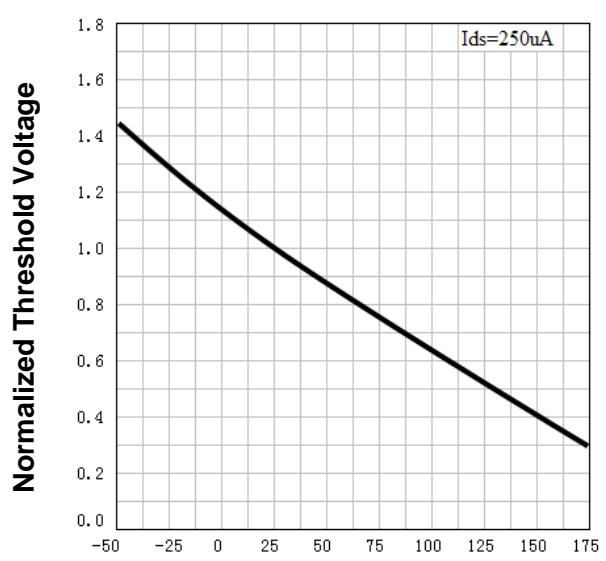

$T_j$  - Junction Temperature (°C)

**Typical Characteristics**

**Drain-Source On Resistance**

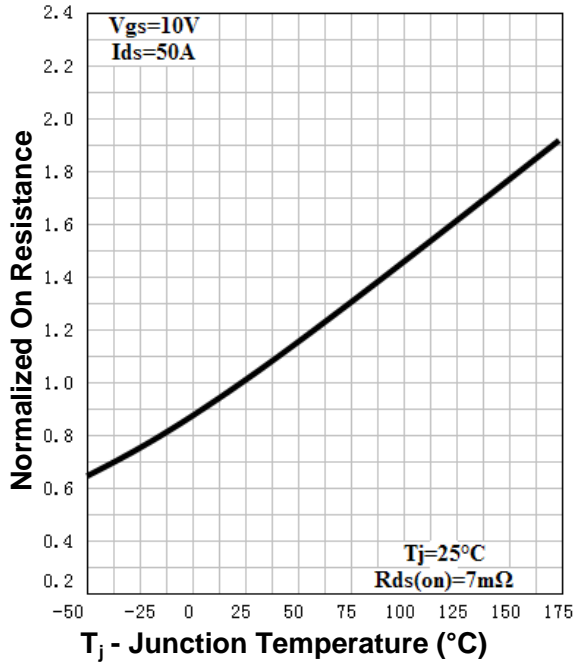

**Source-Drain Diode Forward**

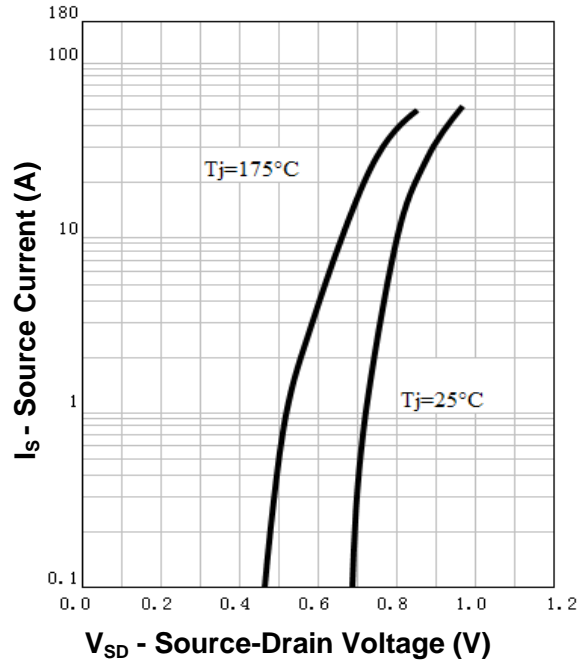

**Capacitance**

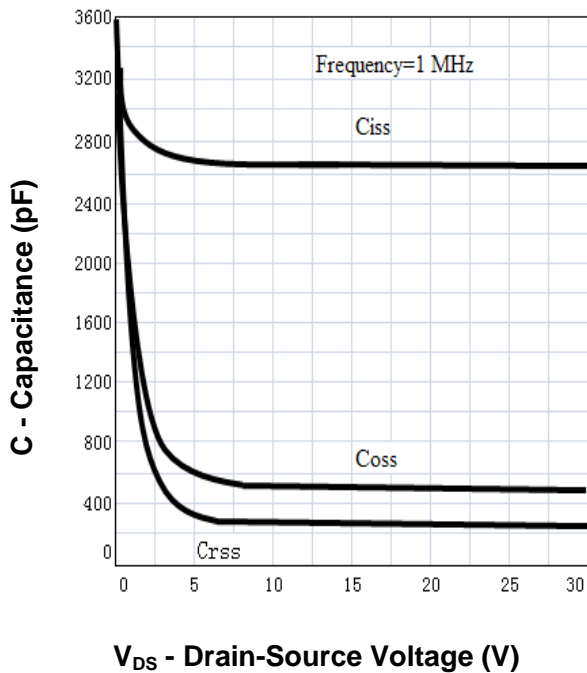

**Gate Charge**

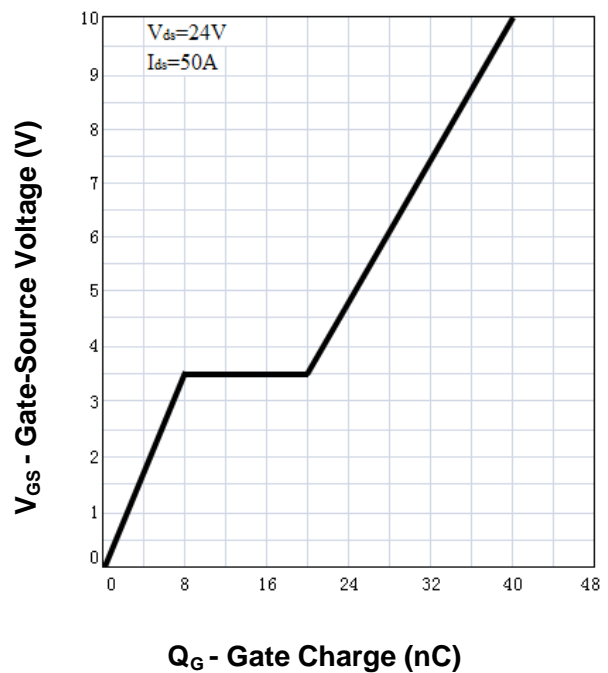

**Avalanche Test Circuit and Waveforms**

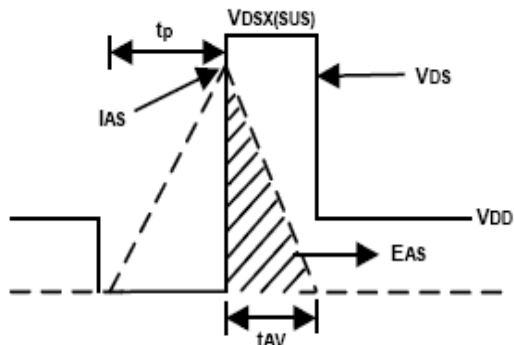
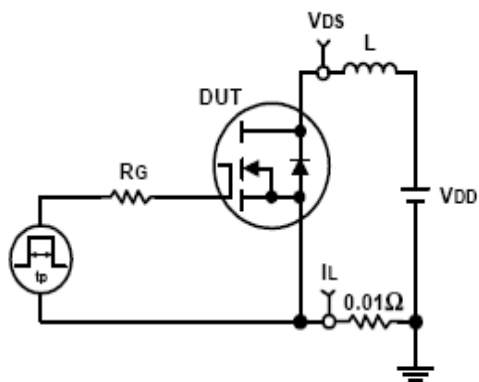

### Switching Time Test Circuit and Waveforms

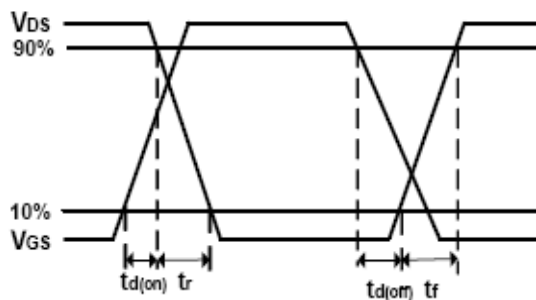
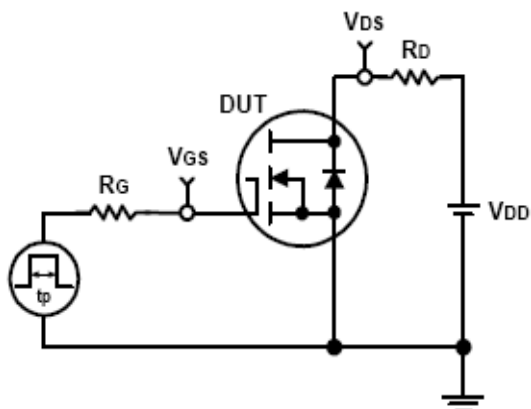

### Ordering and Marking Information

<b>Device</b>	<b>Marking</b>	<b>Package</b>	<b>Packaging</b>	<b>Quantity</b>	<b>Reel Size</b>	<b>Tape width</b>
RU3050L	RU3050L	TO-252	Tape&Reel	2500	13''	16mm

**Package Information**

**TO252-2L**

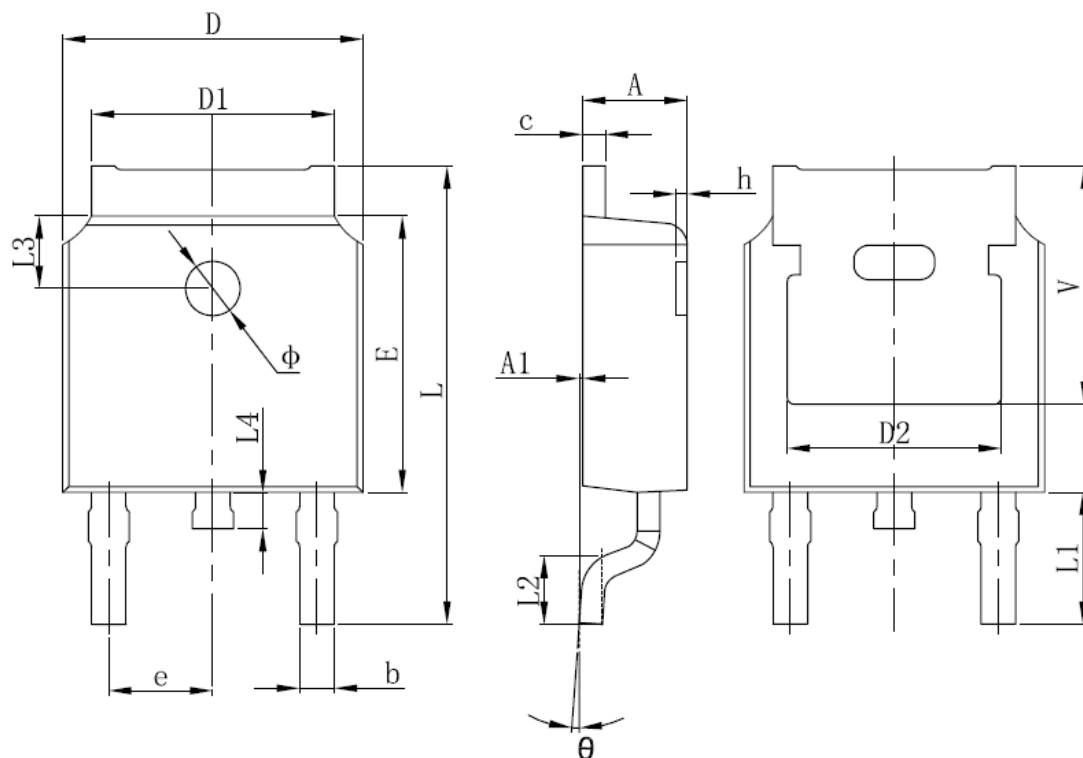

SYMBOL	MM		INCH		SYMBOL	MM		INCH	
	MIN	MAX	MIN	MAX		MIN	MAX	MIN	MAX
A	2.200	2.400	0.087	0.094	L	9.800	10.400	0.386	0.409
A1	0.000	0.127	0.000	0.005	L1	2.900 REF.		0.114 REF.	
b	0.660	0.860	0.026	0.034	L2	1.400	1.700	0.055	0.067
C	0.460	0.580	0.018	0.023	L3	1.600 REF.		0.063 REF.	
D	6.500	6.700	0.256	0.264	L4	0.600	1.000	0.024	0.039
D1	5.100	5.460	0.201	0.215	Φ	1.100	1.300	0.043	0.051
D2	4.830 REF.		0.190 REF.		θ	0°	8°	0°	8°
E	6.000	6.200	0.236	0.244	h	0.000	0.300	0.000	0.012
e	2.186	2.386	0.086	0.094	V	5.350 REF.		0.211 REF.	

ALL DIMENSIONS REFER TO JEDEC STANDARD  
DO NOT INCLUDE MOLD FLASH OR PROTRUSIONS



## **Customer Service**

**Worldwide Sales and Service:**

Sales@ruichips.com

**Technical Support:**

Technical@ruichips.com

**Investor Relations Contacts:**

Investor@ruichips.com

**Marcom Contact:**

Marcom@ruichips.com

**Editorial Contact:**

Editorial@ruichips.com

**HR Contact:**

HR@ruichips.com

**Legal Contact:**

Legal@ruichips.com

**Shen Zhen RUICHIPS Semiconductor CO., LTD**

Room 501, the 5floor An Tong Industrial Building,  
NO.207 Mei Hua Road Fu Tian Area Shen Zhen City, CHINA

**TEL:** (86-755) 8311-5334

**FAX:** (86-755) 8311-4278

**E-mail:** Sales-SZ@ruichips.com