



MD200C08D2 THRU MD200C18D2

THYRISTOR DIODE MODULE

Reverse Voltage - 800 to 1800 Volts Forward Current - 200 Ampere



Glass Passivated Rectifier Diode Modules

VRRM 800 to 1800V

IFAV 200 A

Applications

- Non-controllable rectifiers for AC/AC converters
- Line rectifiers for transistorized AC motor controllers
- Field supply for DC motors

Features

- Blocking voltage: 800 to 1800V
- Heat transfer through aluminum oxide ceramic isolated metal baseplate
- Glass passivated chip
- UL recognized applied for file no. E360040

Circuit

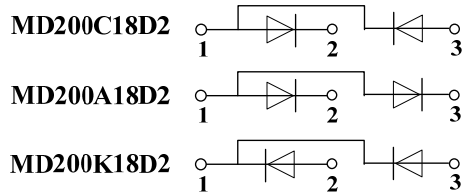

Module Type

TYPE			VRRM	VRSM
MD200C08D2	MD200A08D2	MD200K08D2	800V	900V
MD200C12D2	MD200A12D2	MD200K12D2	1200V	1300V
MD200C16D2	MD200A16D2	MD200K16D2	1600V	1700V
MD200C18D2	MD200A18D2	MD200K18D2	1800V	1900V

Maximum Ratings

Symbol	Conditions	Values	Units
IFAV	Single phase ,half wave 180° conduction Tc=95°C	200	A
IFSM	t=10mS Tvj =45°C	6800	A
i ² t	t=10mS Tvj =45°C	231200	A ² s
V _{isol}	a.c.50HZ;r.m.s.;1min	3000	V
T _{vj}		-40 to 150	°C
T _{stg}		-40 to 125	°C
Mt	To terminals(M6)	5±15%	Nm
Ms	To heatsink(M6)	5±15%	Nm
Weight	Module (Approximately)	160	g



MD200C08D2 THRU MD200C18D2

THYRISTOR DIODE MODULE

Reverse Voltage - 800 to 1800 Volts Forward Current - 200 Ampere

Thermal Characteristics

Symbol	Conditions	Values	Units
$R_{th(j-c)}$	Per diode	0.18	$^{\circ}C/W$
$R_{th(c-s)}$	Module	0.05	$^{\circ}C/W$

Electrical Characteristics

Symbol	Conditions	Values			Units
		Min.	Typ.	Max.	
V _{FM}	T=25 $^{\circ}C$ I _F =300A	—	1.18	1.30	V
I _{RD}	T _{vj} =150 $^{\circ}C$ V _{RD} =V _{RRM}	—	—	9	mA
r _f	T _J =25 $^{\circ}C$		1.13		m Ω
V _{f0}			0.84		V

Performance Curves

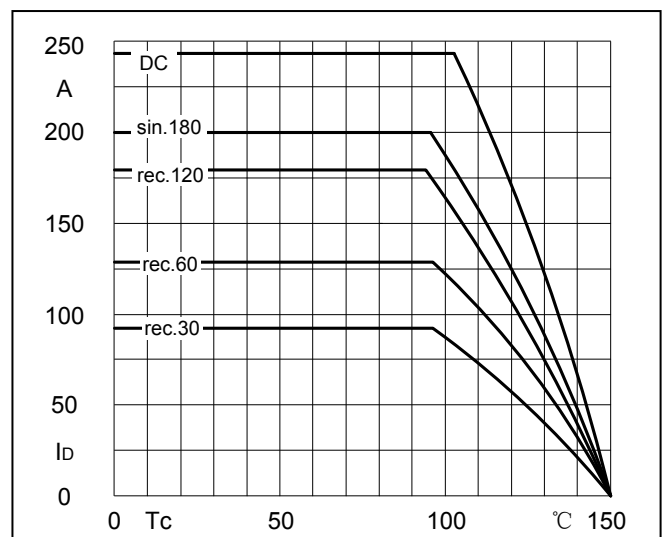
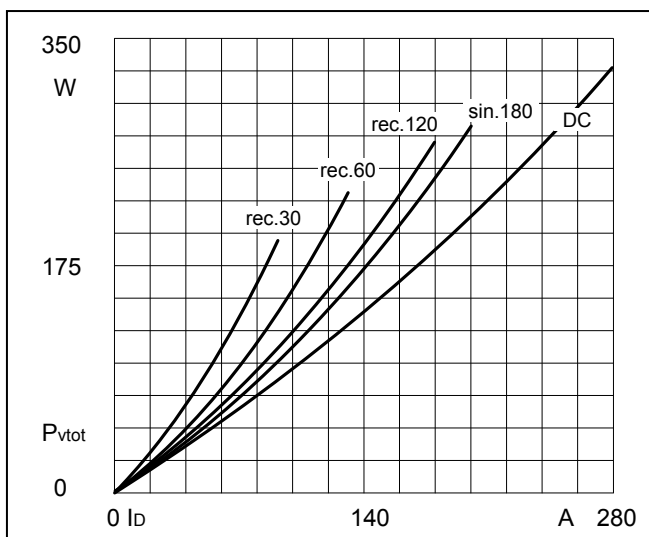



MD200C08D2 THRU MD200C18D2

THYRISTOR DIODE MODULE

Reverse Voltage - 800 to 1800 Volts Forward Current - 200 Ampere

Performance Curves

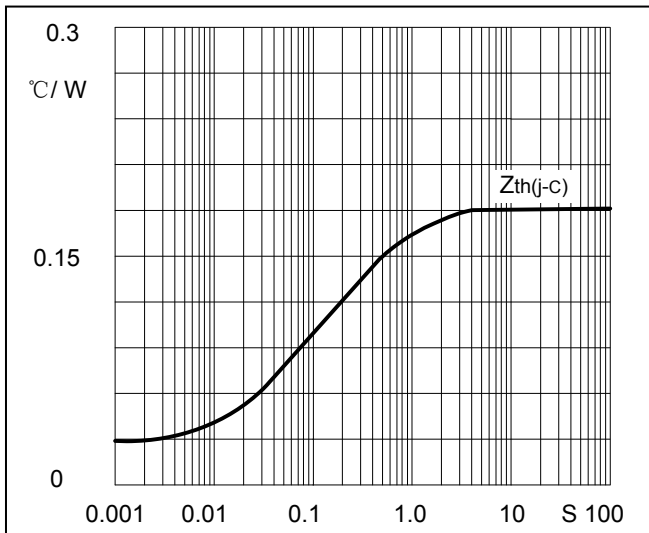

Fig3. Transient thermal impedance

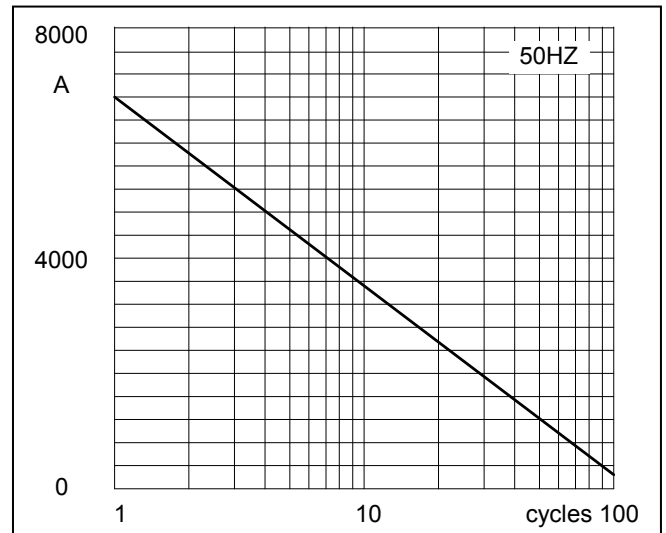

Fig4. Max Non-Repetitive Forward Surge Current

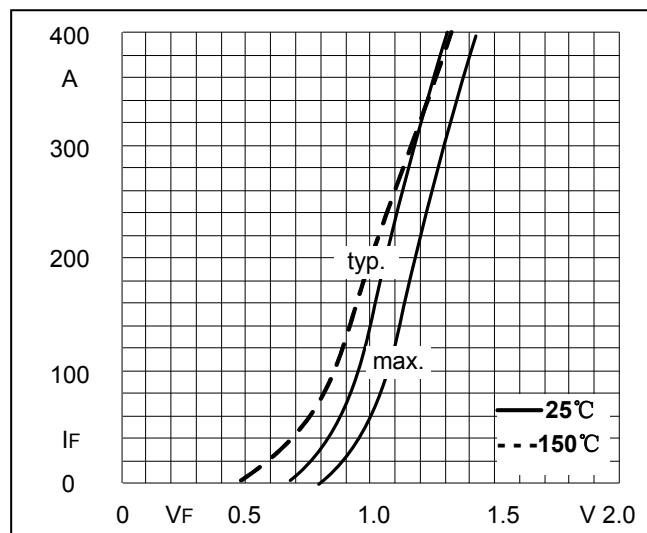

Fig5. Forward Characteristics



MD200C08D2 THRU MD200C18D2

THYRISTOR DIODE MODULE

Reverse Voltage - 800 to 1800 Volts Forward Current - 200 Ampere

Package Outline Information

CASE: D2

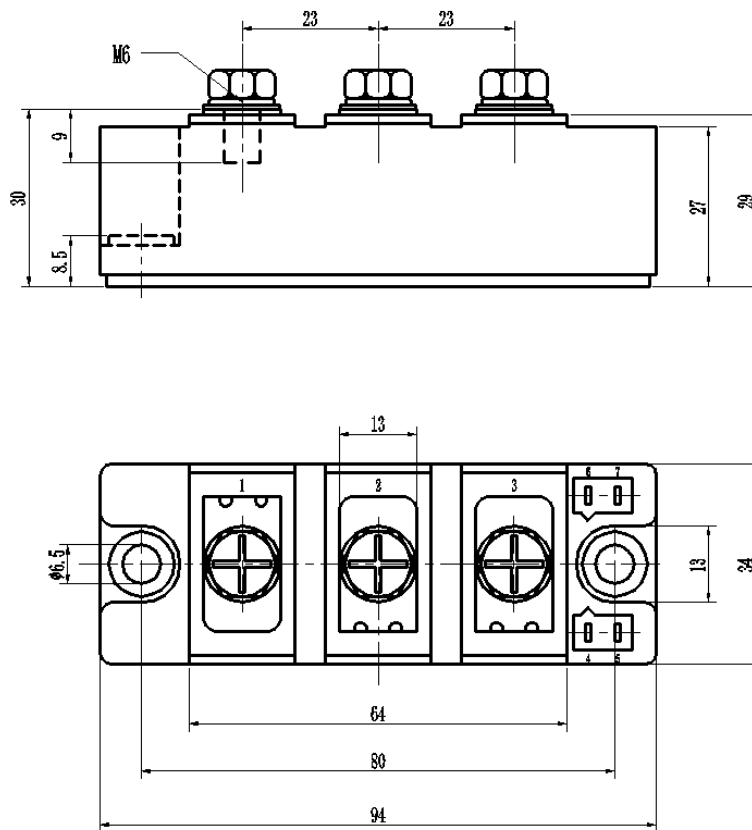

Dimensions in mm