



MA603.A.ABK.001  
on ground-plane



## Spartan

MA603.A.ABK.001

## Specification

<b>Part No.</b>	<b>MA603.A.ABK.001</b>
<b>Product Name</b>	<b>Spartan</b> 3in1 MA.603 Low Profile Screw Mount (Permanent Mount) GPS/GLONASS/Cellular/915MHz Combination Antenna
<b>Feature</b>	Cellular <ul style="list-style-type: none"> <li>• 850/900/1700/1800/2100MHz</li> <li>• GSM/CDMA/UMTS/HSPA</li> </ul> GPS/GLONASS – 1575~1602MHz 5dBiC 915MHz (902MHz~928 MHz) 3dBi [incl. 3M cable] IP67 Waterproof High Efficiency / Peak Gain Outdoor Antenna Advanced RF Design and Materials Heavy Duty – Integrated Metal Base / Ground-plane Standard 3 meters low loss cables Custom cables and connectors available RoHS Compliant

# 1. Introduction

The Spartan MA603 antenna is a low profile, heavy-duty, fully IP67 waterproof external M2M antenna for use in telematics, transportation and remote monitoring applications.

The Spartan MA603 antenna is unique in the market because it combines 3in1 GPS/GLONASS, Cellular (2G and 3G) and 915MHz antennas in a heavy-duty structure with high efficiency in a low profile compact format at 35mm(1.38") profile Height. The antenna screws down permanently

onto a roof or metal panel and can be pole or wall-mounted. For industries such as commercial vehicle telematics, remote monitoring, smart meter systems, construction equipment, at only 35mm high, the Spartan provides an unobtrusive, robust, rugged antenna that is durable even in extreme environments.

Custom designed integrated wall mounted and pole mounted brackets are available for the Spartan antennas.

These patent pending mounts allow for

180 degrees freedom of movement of the antennas for ease of positioning while also preventing access to the cables so they cannot be cut by vandals or thieves and also protecting the cables from long term weather exposure. The removal of unsightly cables also leads to a cleaner more professional installation and look, and makes the antenna less identifiable and more unobtrusive. Customized cable sleeves can be supplied for extra protection where required.

# 2. Specification

## GPS-GLONASS

<b>Centre Frequency</b>	1575.42MHz / 1602MHz
<b>Bandwidth</b>	10MHz
<b>Radiation Efficiency</b>	50 (without cable)
<b>Passive Gain @ Zenith</b>	4.0 typ (with $\psi = 140\text{mm}$ ground)
<b>VSWR</b>	2
<b>Impedance</b>	50 $\Omega$
<b>DC Power Input Range</b>	3 ~ 5V

DC input	3.3V		4.0V		5.5V	
MHz	1575.42	1602	1575.42	1602	1575.42	1602
<b>VSWR</b>	2	2	2	2	2	2
<b>LNA Gain</b>	29.2	29	31	31	32.3	32
<b>Noise Figure</b>	3.1	3.1	3.2	3.2	3.4	3.4
<b>Power Consumption</b>	7.5	7.5	9.4	9.4	15	15
<b>Band Attenuation</b>	1520MHz: -20dB 1642MHz: -20dB		1520MHz: -20dB 1642MHz: -20dB		1520MHz: -20dB 1642MHz: -20dB	

<b>Cable</b>	3M RG-174 standard, fully customizable
<b>Connector</b>	SMA(M) standard, fully customizable

## 2. Specification

### Cellular

<b>Frequency (GHz)</b>	824 ~ 896	880 ~ 960	1710 ~ 1880	1850 ~ 1990	1710 ~ 2170
<b>Peak Gain (dBi)</b>	2.1	-0.2	2.9	3.0	5.1
<b>Average (dBi)</b>	-4.7	-7.5	-2.7	-3.1	-3.1
<b>Efficiency</b>	35%	20%	51%	49%	49%
<b>Impedance</b>	50Ω				
<b>Polarization</b>	Linear				
<b>Radiation Pattern</b>	Omni				
<b>Cable</b>	3M CFD200 standard, fully customizable				
<b>Connector</b>	SMA(M) standard, fully customizable				

### ELECTRICAL – 915Mhz

<b>Frequency (MHz)</b>	902MHz	915MHz	929MHz
<b>Gain (dBi) *</b>	3.2	2.3	2.7
<b>Efficiency (%) *</b>	49	44	42
<b>VSWR</b>	1.92 Max		

\* Including 3 meters cable loss

<b>Cable</b>	3M CFD200 standard, fully customizable
<b>Connector</b>	SMA(M) standard, fully customizable

### Mechanical

<b>Antenna Dimensions</b>	Height 35.1mm (1.38") x Diameter 145.6mm (5.73")
<b>Housing</b>	UV resistant ABS
<b>Base and thread</b>	Zinc
<b>Waterproof</b>	IP67

### Environmental

<b>Operating Temperature</b>	-40°C to 85°C
<b>Storage Temperature</b>	-40°C to 80°C
<b>Humidity</b>	Non-condensing 65°C 95% RH

### 3. GPS/GLONASS Antenna Characteristics

#### 3.1 Block Diagram

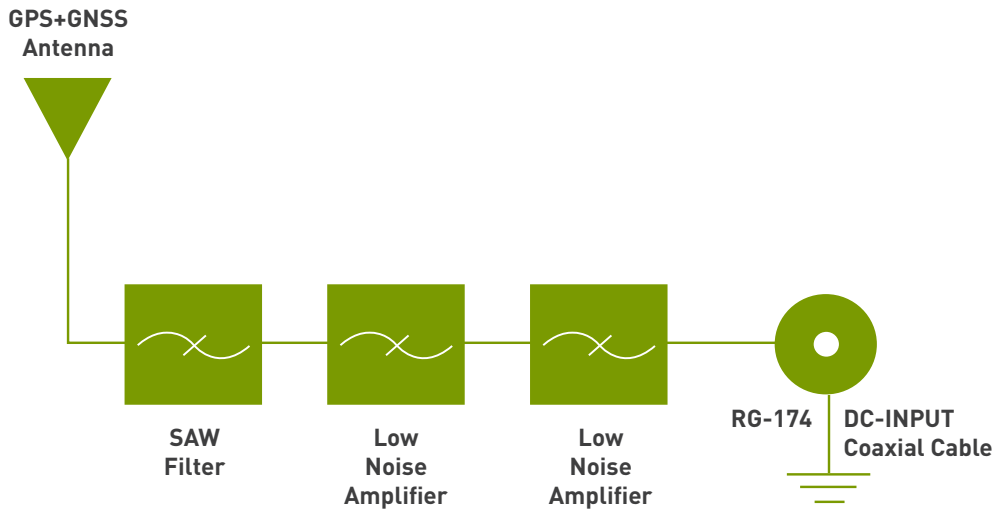

#### 3.2 Return Loss

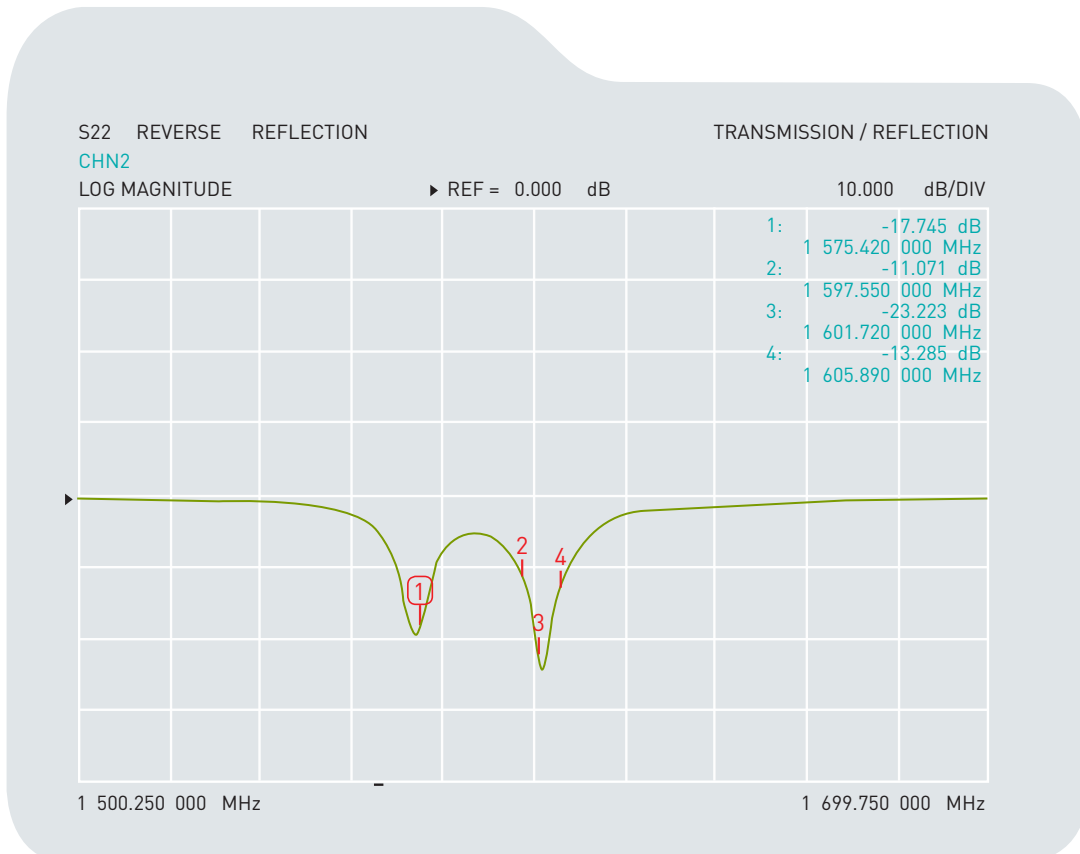

### 3.3 GPS/GLONASS Antenna Radiation Pattern

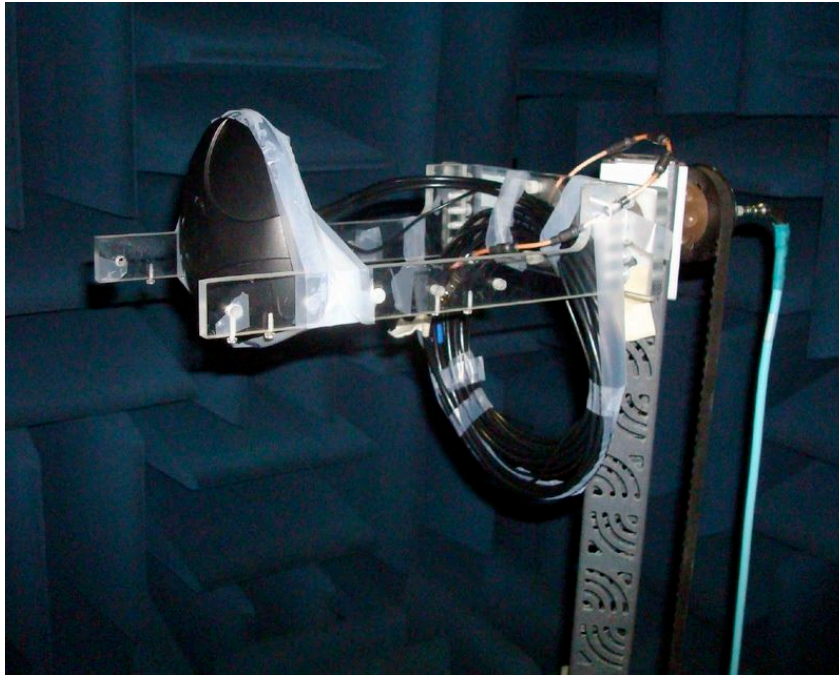

MA.600 tested in CTIA approved 3D chamber



XYZ co-ordinate for reference

### 3.4 Radiation Pattern

XZ-plane Free Space @1575.42MHz

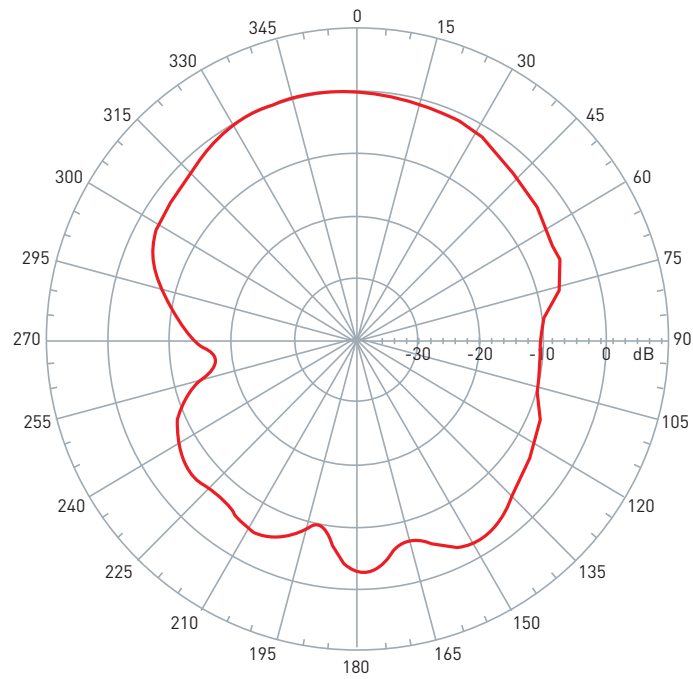

YZ-plane Free Space @1575.42MHz

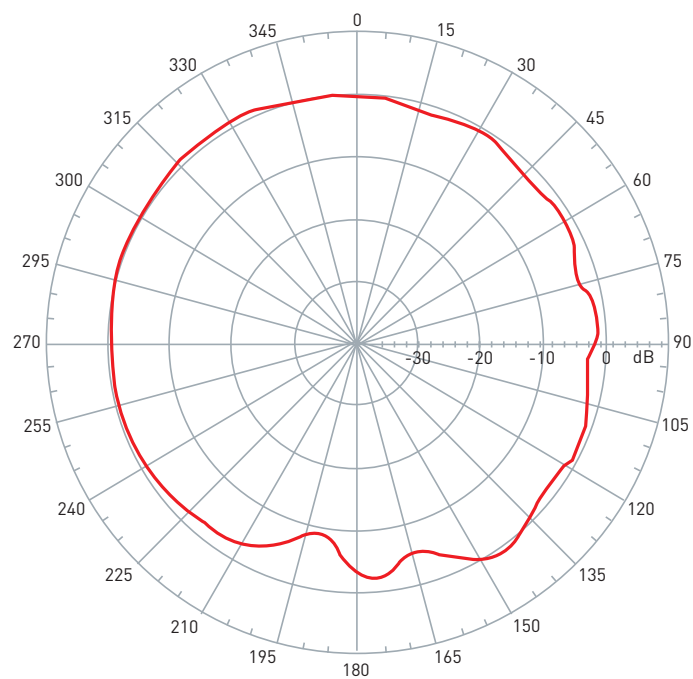

### 3.4 Radiation Pattern

XZ-plane Free Space @1602MHz

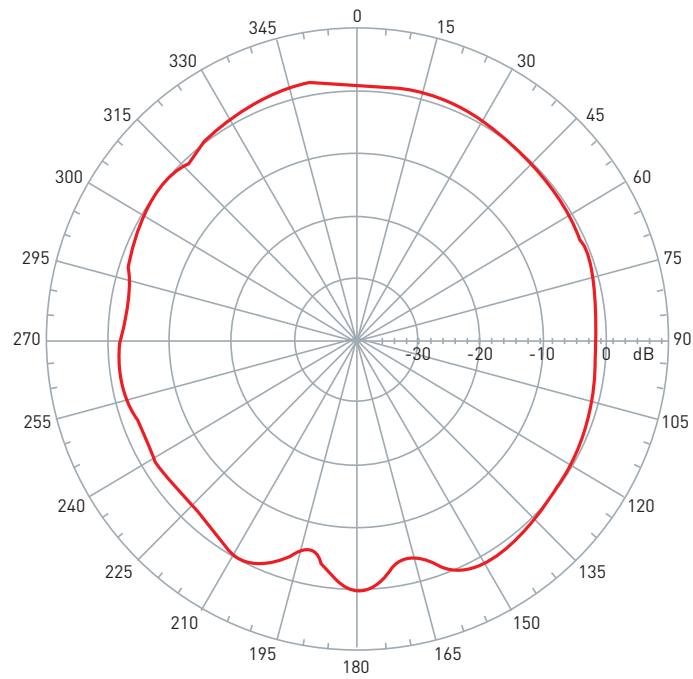

YZ-plane Free Space @1602MHz

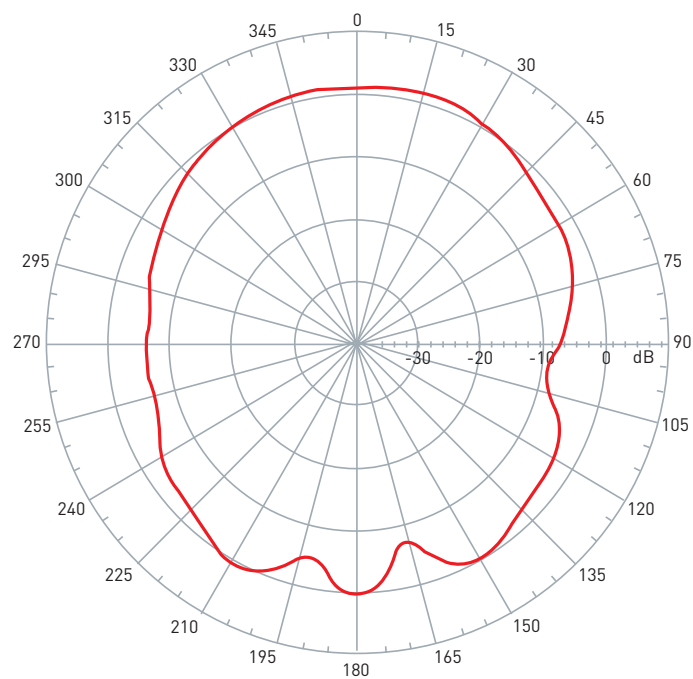

### 3.5 GPS/GLONASS LNA

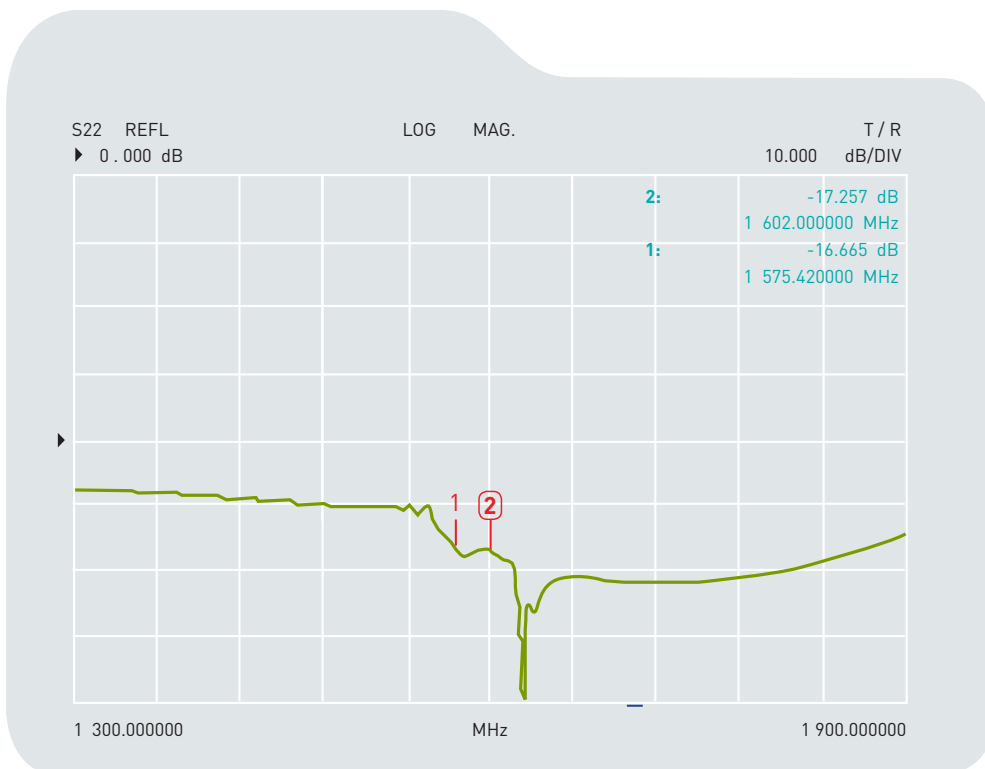
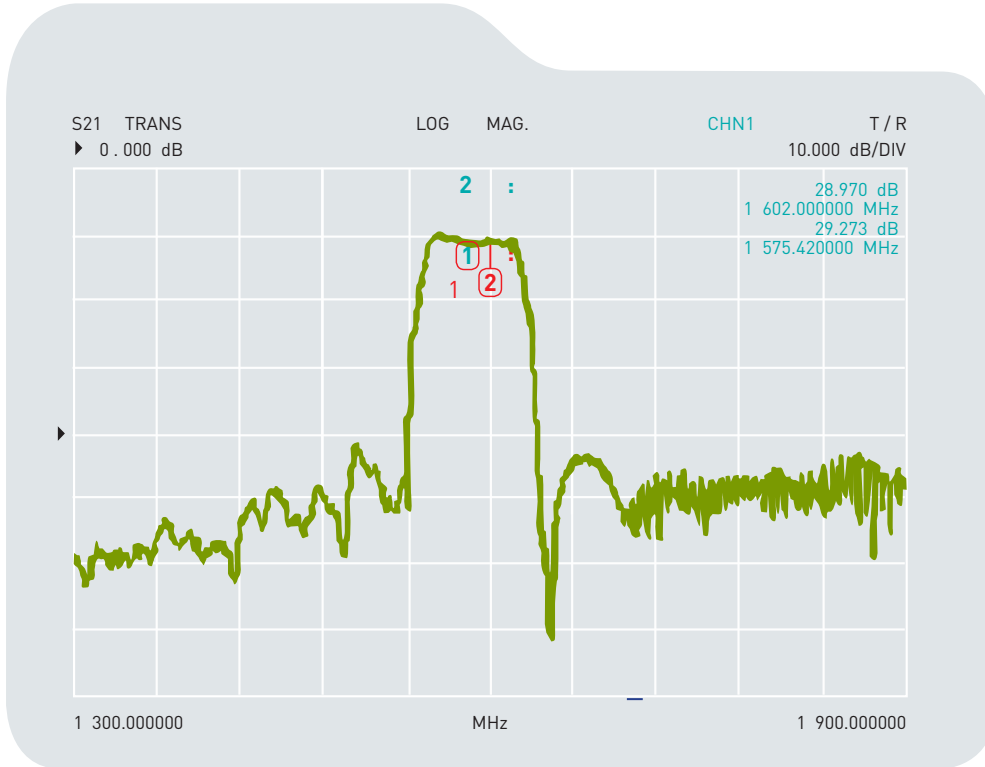



## 4. Cellular Antenna Characteristics

### 4.1 Return Loss

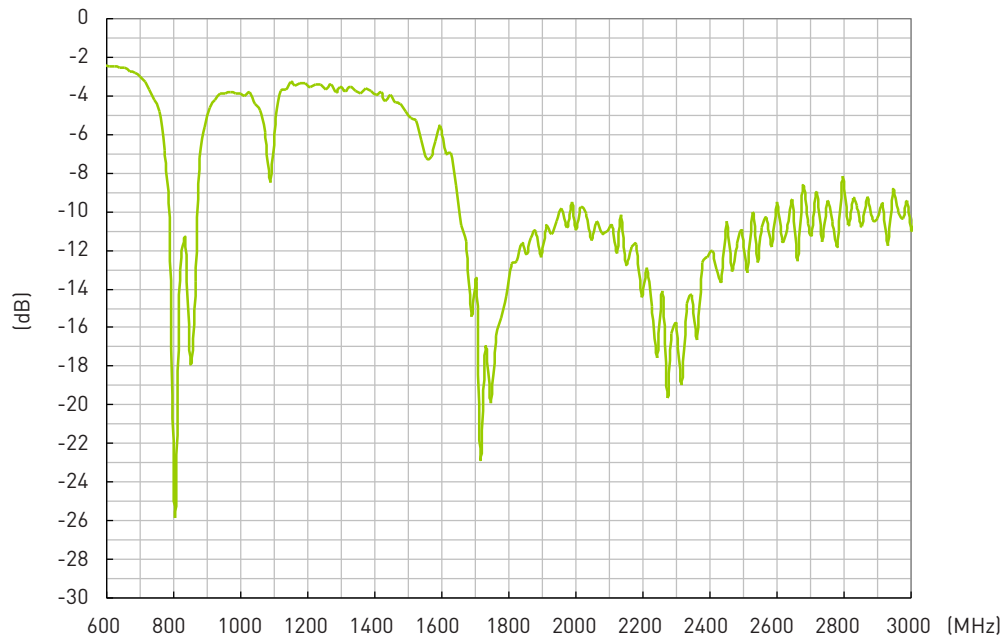

### 4.2 VSWR

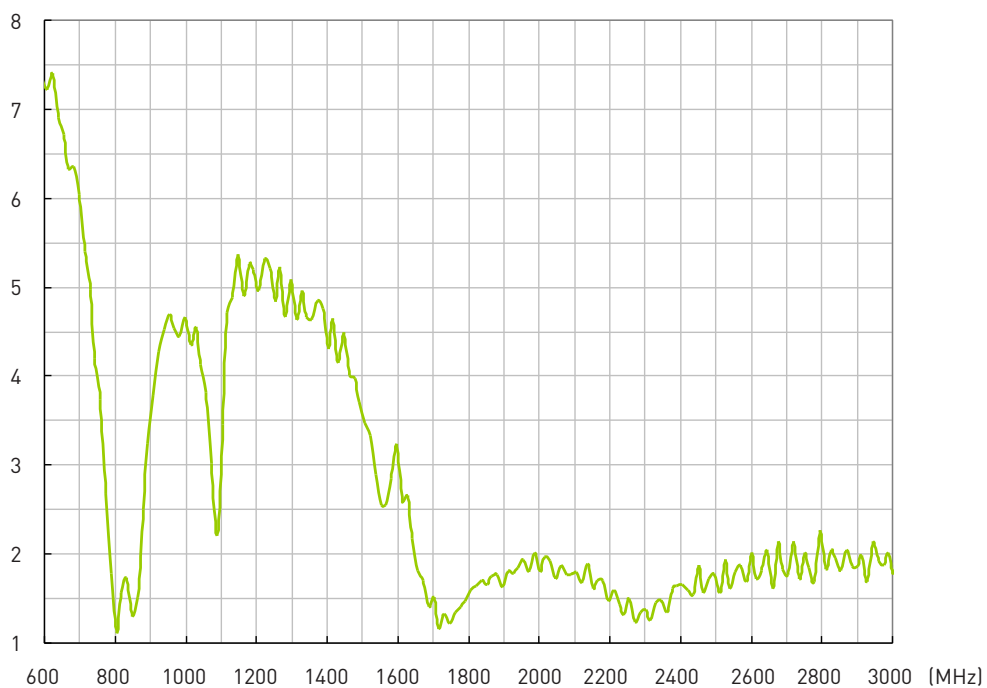

## 4. Cellular Antenna Characteristics

### 4.3 Cellular Antenna Efficiency

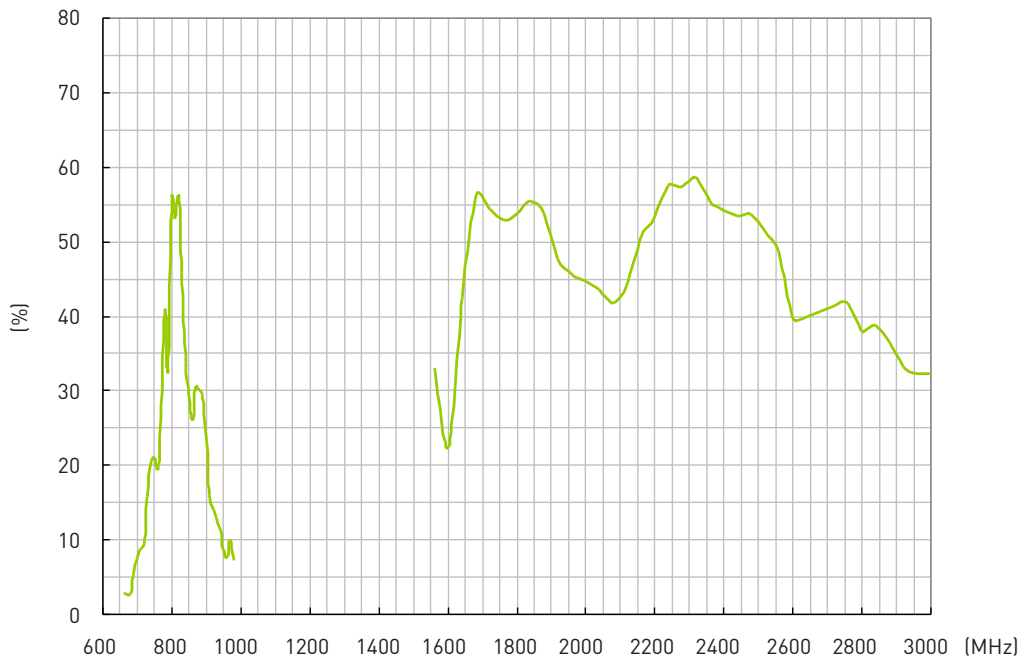

### 4.4 Cellular Antenna Peak Gain

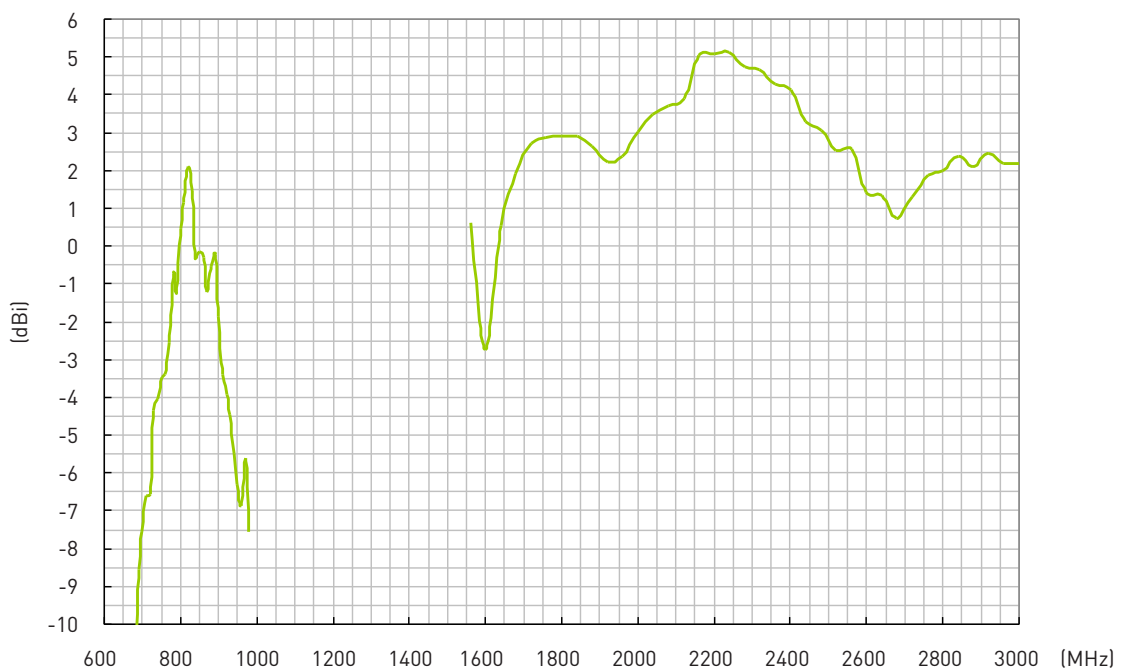

## 4.5 Cellular Antenna 3D Average Gain

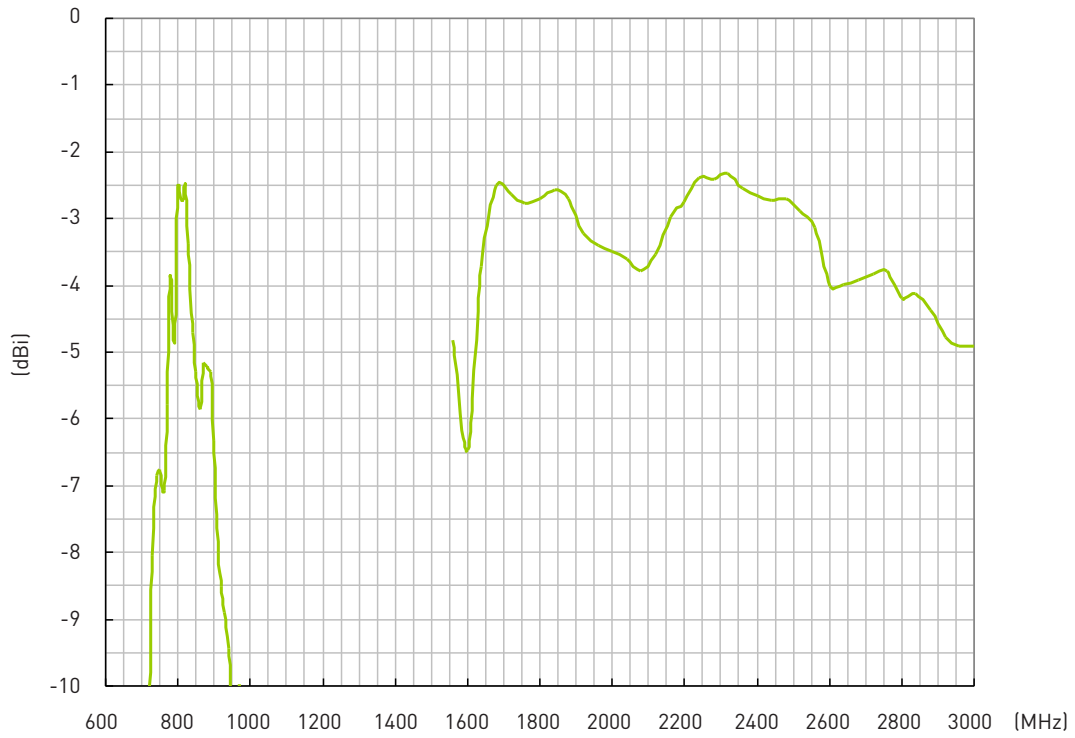

## 5. Cellular Antenna Radiation Pattern

### 5.1 XY-Plane

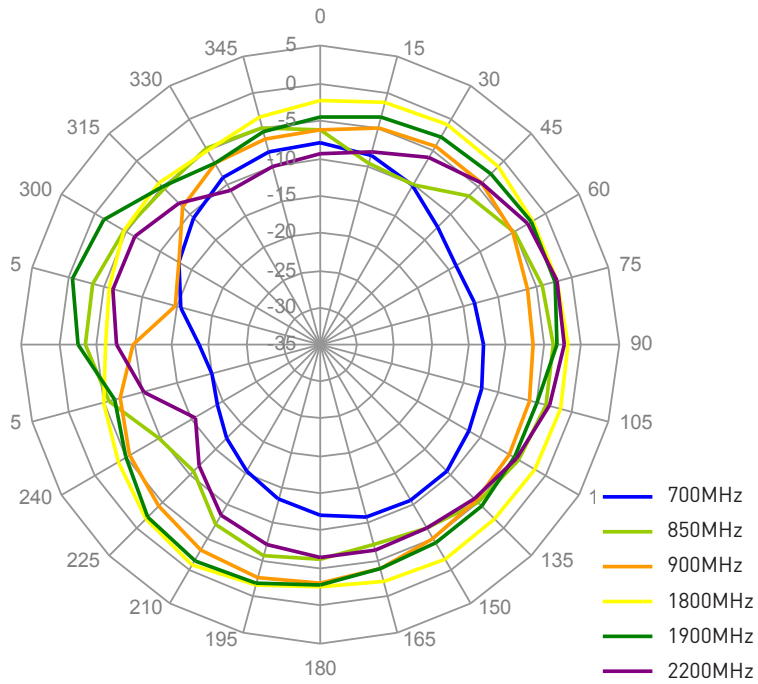

### 5.2 XZ-Plane

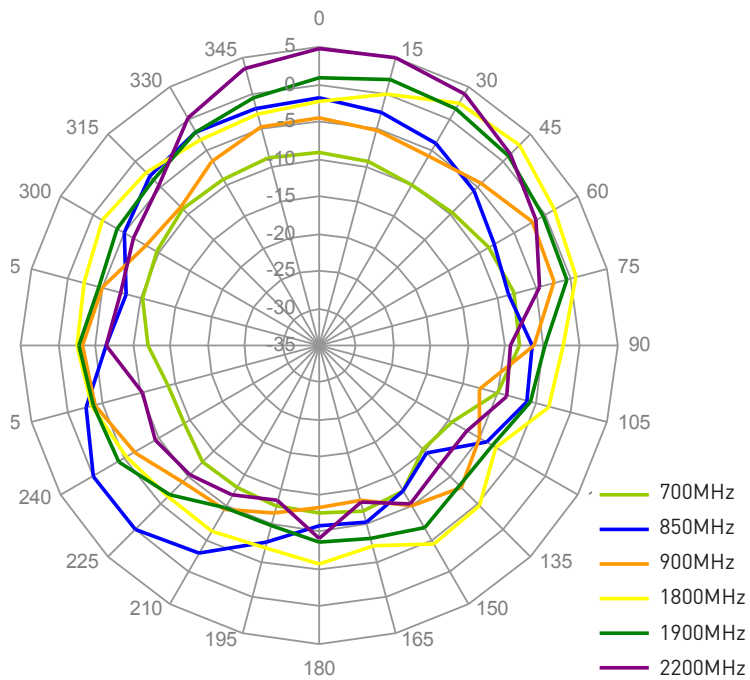

## 6. 915MHz Antenna

### 6.1 Return Loss

1 Active Ch/Trace 2 Response 3 Stimulus 4 Mkr/Analysis 5 Instr State

▶ Tr1 S11 Log Mag 10.00dB/ Ref -10.00dB [F2]

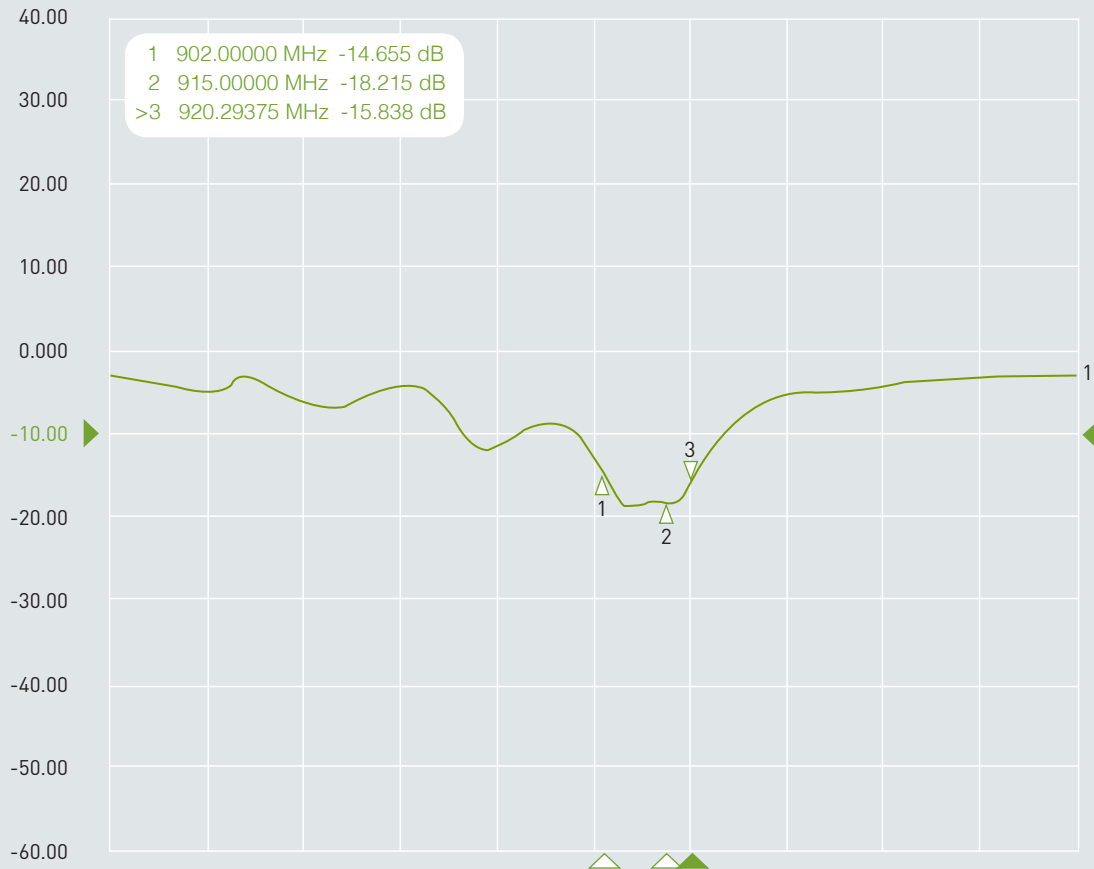

1 Start 800 MHz

IFBW 70 kHz

Stop 1 GHz C? !

## 6. 915MHz Antenna

### 6.2 Antenna Radiation Patterns - Freespace

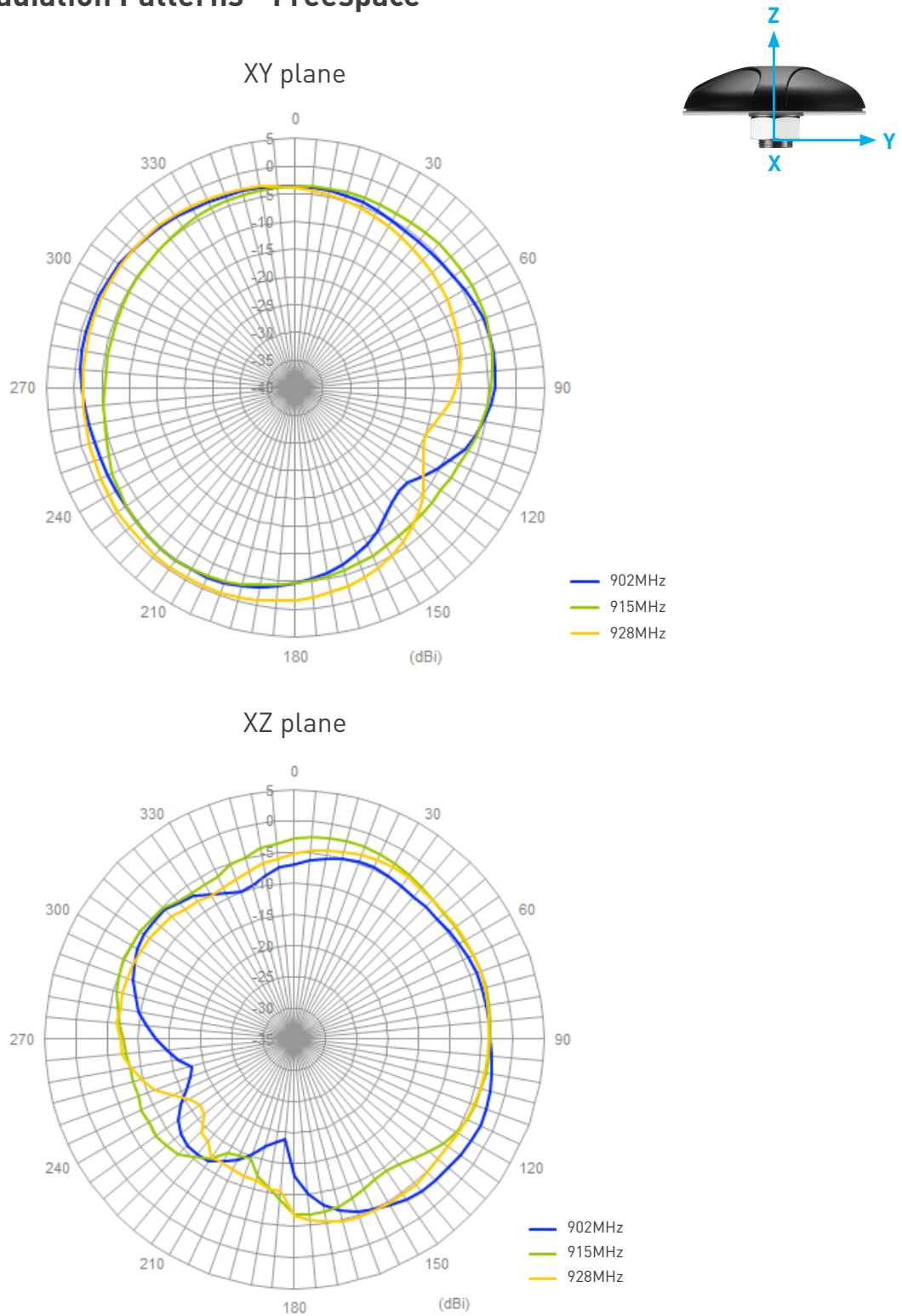

## 6. 915MHz Antenna

### 6.3 915MHz Antenna – on metal ground plane

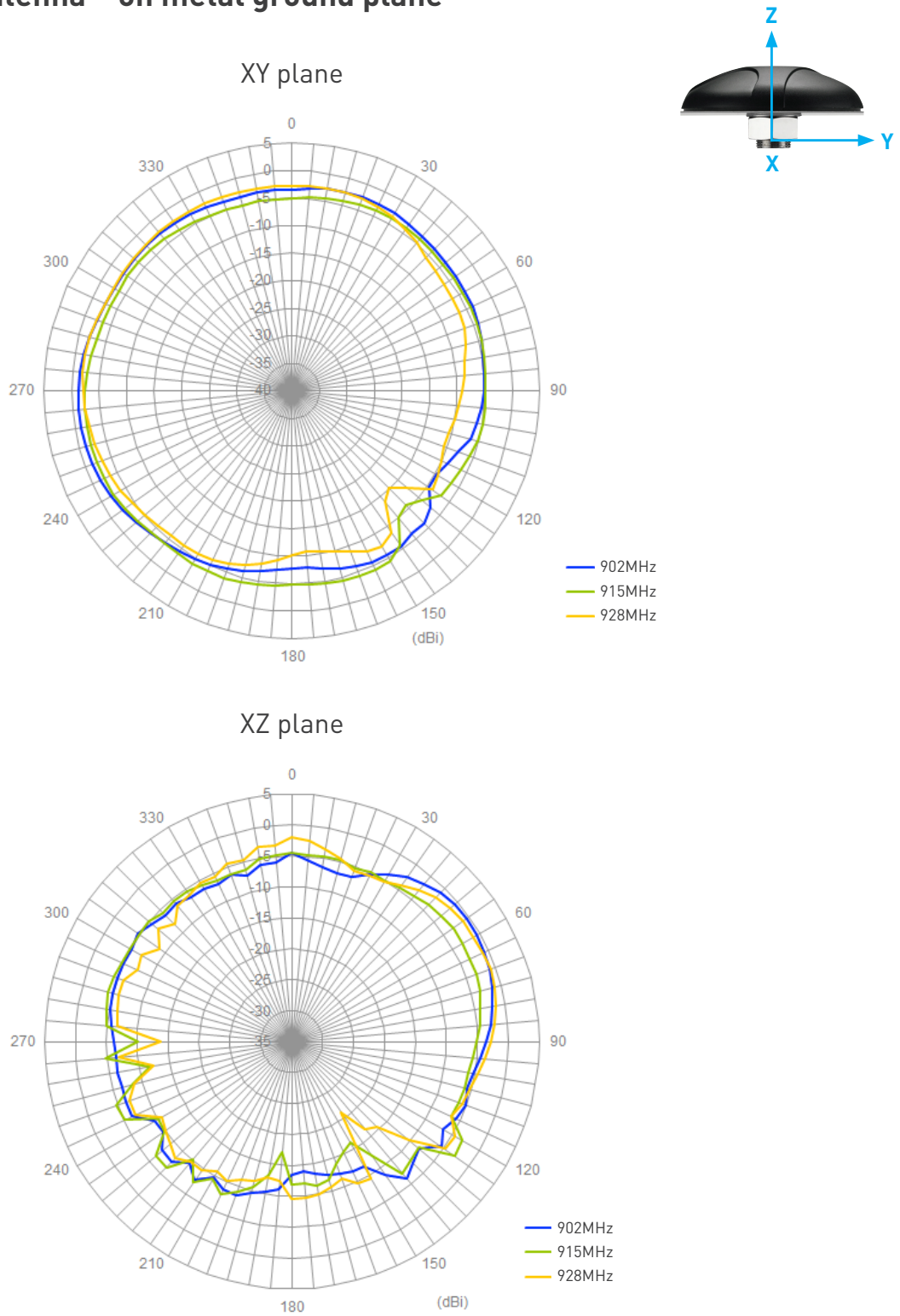

## 7. Mechanical Drawing

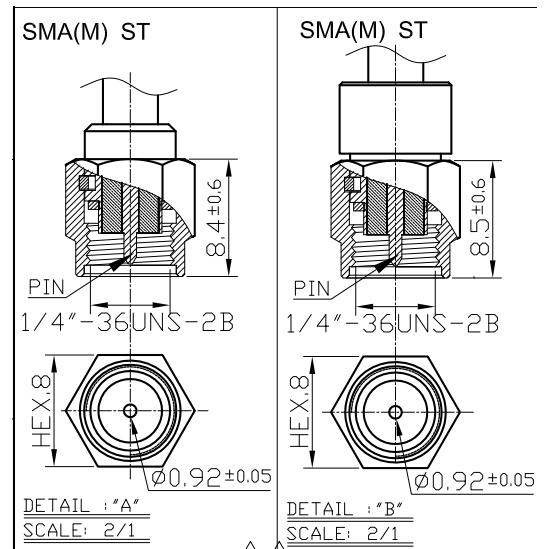
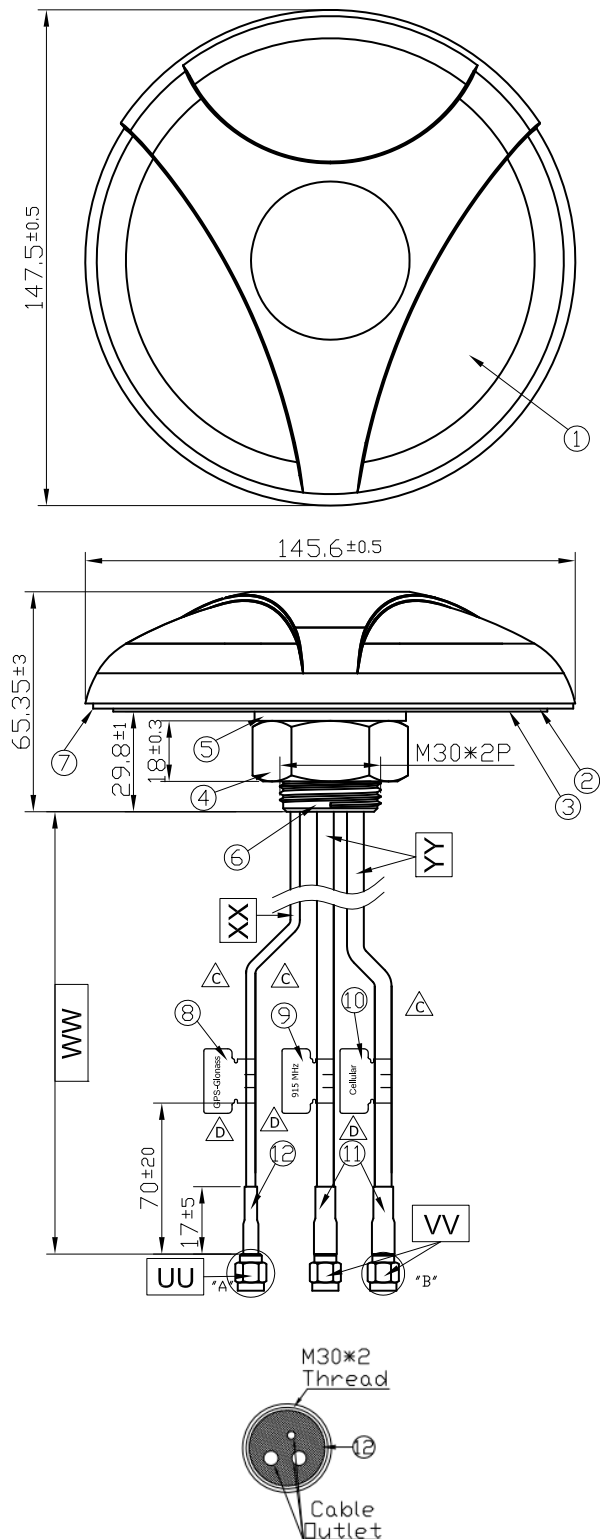

Name	Material	Finish	QTY
1 Housing	PC 540	Black	1
2 Closed Cell Foam	CR 4305	Black	1
3 3M Double Adhesive	3M 9448 HK	White Liner	1
4 M30 Nut	Steel AISI 1215	Ni Plated	1
5 Washer	Steel AISI 1215	Ni Plated	1
6 M30 x 2 Thread 32L	Zinc Alloy	Ni Plated	1
7 Waterproof Rubber	Silicon	Black	1
8 GPS-Glonass Label	Gloss Silver PET	Orange	1
9 915 MHz Label	Gloss Silver PET	Olive Drab	1
10 Cellular Label	Gloss Silver PET	Blue	1
11 Heat Shrink Tube (CFD200)	PE	Black	2
12 Heat Shrink Tube (RG174)	PE	Black	1

Name	Spec	Finish	QTY
UU Connector Type	SMA(M) ST	Gold	1
VV Connector Type	SMA(M) ST	Gold	2
WW Cable Length	3000±120mm		1
XX Cable Type	RG174	Black	1
YY Cable Type	CFD 200	Black	2



## 8. Packaging

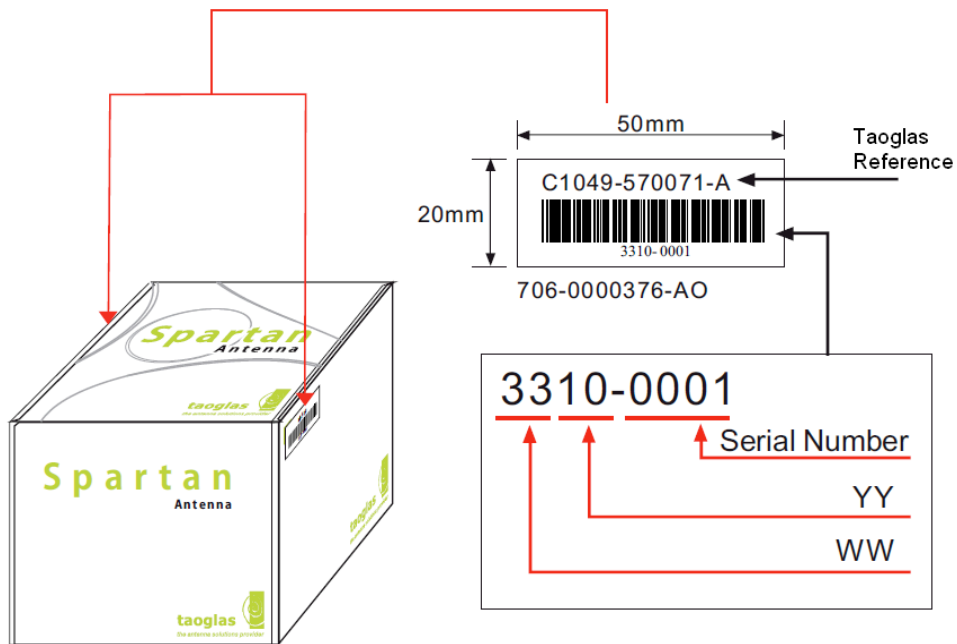
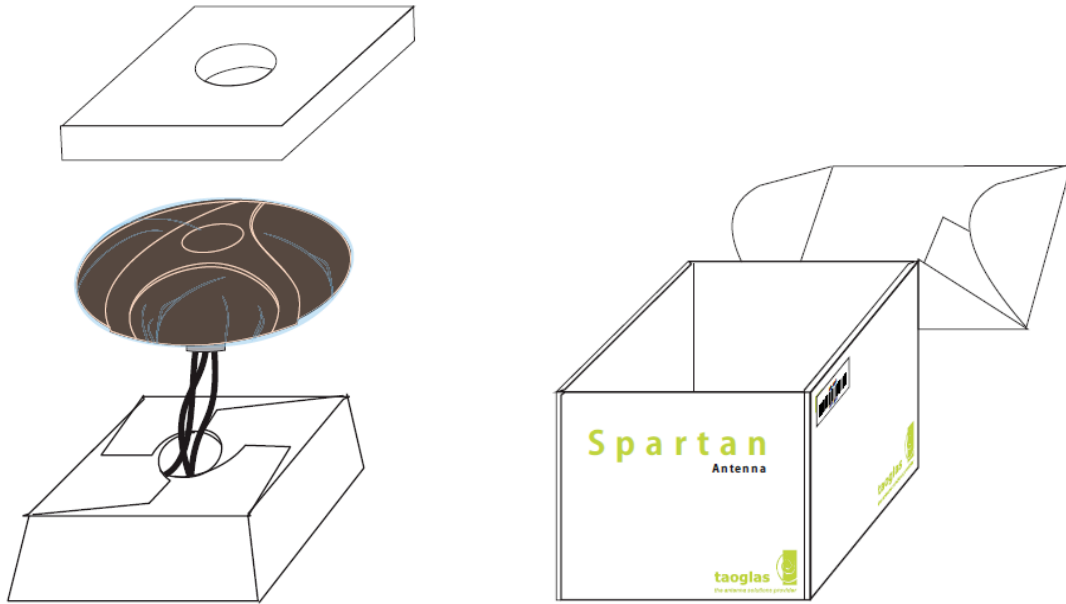

## 8. Packaging

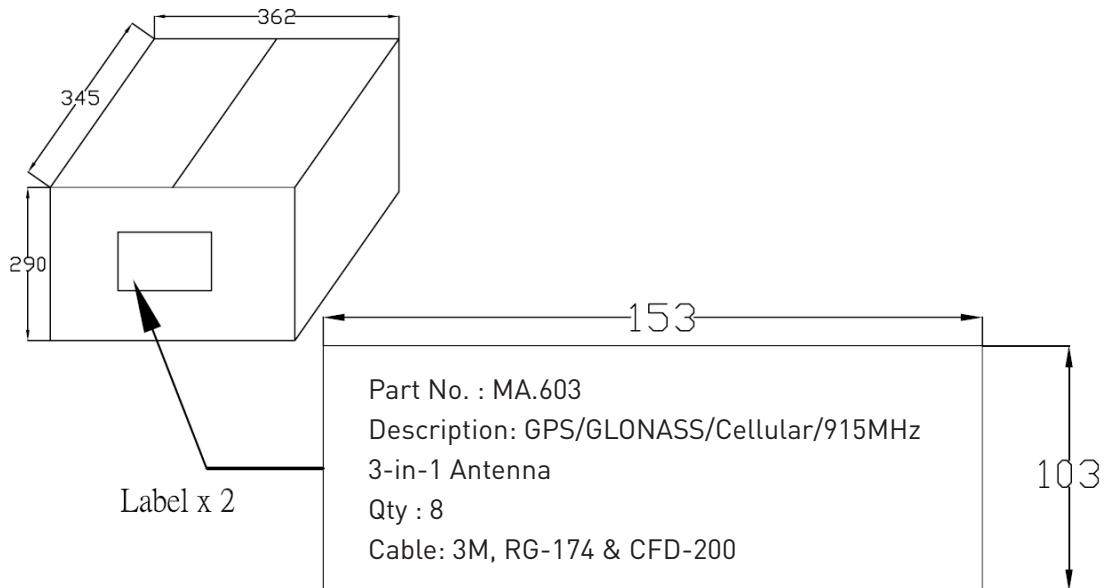

Taoglas makes no warranties based on the accuracy or completeness of the contents of this document and reserves the right to make changes to specifications and

product descriptions at any time without notice. Taoglas reserves all rights to this document and the information contained herein.

Reproduction, use or disclosure to third parties without express permission is strictly prohibited.  
Copyright © Taoglas Ltd.