

# Synchronous 600 mA Step-Down DC/DC Converter

## FEATURES

- Built-in transistors
- Operating Input Voltage Range: 2.0 V ~ 6.0 V (A/B/C types) or 1.8 V ~ 6.0 V (D/E/F/G types)
- Output Voltage Range Externally Set: 0.8 V ~ 4.0 V (internally set) or 0.9 ~ 6.0 V (externally set)
- Output Current: 600 mA
- High Efficiency: 92%
- Oscillation Frequency: 1.2 MHz, 3 MHz
- Maximum Duty Cycle: 100%
- Operating Modes: PWM, PWM/PFM auto select or PWM/PFM manual select
- Functions: Build-in Current Limit, Load Capacitor Discharge, High Speed Soft start
- Operating Ambient temperature: -40 ~ +85°C
- Packages: SOT-25, USP-6C, USP-6EL, WLP-5-03
- EU RoHS Compliant, Pb Free

## APPLICATION

- Mobile Phones
- Bluetooth headsets
- Digital home appliances
- Office automation equipment
- Various portable equipment

## DESCRIPTION

The IXD3235/36/37 series is a group of synchronous-rectification type DC/DC converters with a built-in 0.52  $\Omega$  N-channel synchronous rectification transistor and 0.42  $\Omega$  P-channel switching transistor providing up to 600 mA output current.

## TYPICAL APPLICATION CIRCUITS

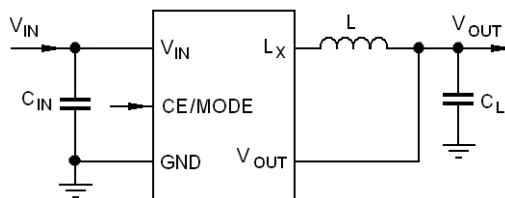

IXD3235/36/37 A, B, C, E, and G types

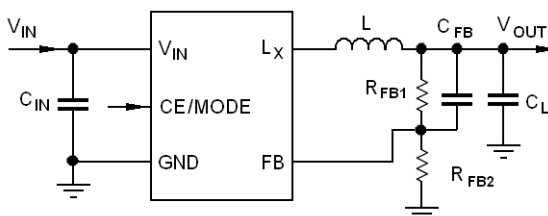

IXD3235/36/37 D and F types

Operating voltage range is from 2.0 V to 6.0 V (A ~ C types) or 1.8 V to 6.0 V (D ~ G types). For the D/F types, which have a reference voltage of 0.8 V with  $\pm 2.0\%$  accuracy, the output voltage can be set from 0.9 V by using two external resistors.

The A/B/C/E/G types have a fixed output voltage from 0.8 V to 4.0 V in increments of 0.05 V with  $\pm 2.0\%$  accuracy. The device requires only an inductor and two externally connected ceramic capacitors. The built-in oscillator, either 1.2 MHz or 3.0 MHz, can be selected.

The IXD3235 operates in PWM mode, the IXD3236 automatically switches between PWM/PFM modes, and the IXD3237 allows switch manually between the PWM and the automatic PWM/PFM switching control modes. This allows fast response, low ripple, and high efficiency over the full range of loads from light to heavy.

The soft start and current control functions are internally optimized. All circuits are disabled in a standby mode to reduce current consumption to less than 1.0  $\mu$ A.

The B/F/G types have a 0.25 ms high-speed soft-start for quick turn-on. The built-in Under Voltage Lockout (UVLO) function forces the internal P-channel transistor OFF, when input voltage becomes 1.4 V or lower.

The B to G types have the output capacitor  $C_L$  discharge circuitry, which allows fast  $C_L$  discharge when IC goes into standby mode.

Device is available in four types of packages: SOT-25, USP-6C, USP-6EL, and WLP-5-03.

## TYPICAL PERFORMANCE CHARACTERISTIC

Efficiency vs. Output Current ( $f_{osc} = 1.2$  MHz,  $V_{OUT} = 1.8$  V)  
PWM/PFM Automatic Switching mode

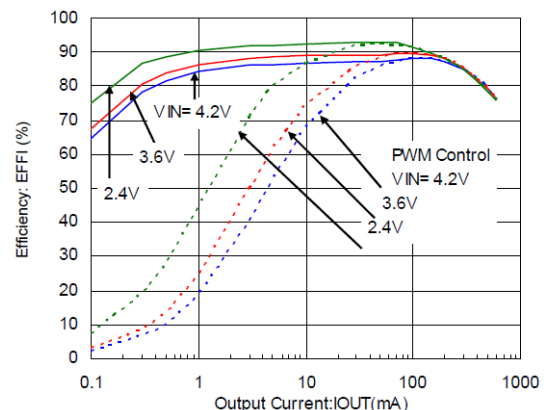

## ABSOLUTE MAXIMUM RATINGS

PARAMETER		SYMBOL	RATINGS	UNITS
V <sub>IN</sub> Pin Voltage		V <sub>IN</sub>	- 0.3 ~ 6.5	V
L <sub>X</sub> Pin Voltage		V <sub>LX</sub>	- 0.3 ~ V <sub>IN</sub> + 0.3 <sup>1</sup>	V
V <sub>OUT</sub> Pin Voltage		V <sub>OUT</sub>	- 0.3 ~ 6.5	V
FB Pin Voltage		V <sub>FB</sub>	- 0.3 ~ 6.5	V
CE/MODE Pin Voltage		V <sub>CE</sub>	- 0.3 ~ 6.5	V
Lx Pin Current		I <sub>LX</sub>	±1500	mA
Power Dissipation	SOT-25	P <sub>D</sub>	250	mW
	USP-6C		120	
	USP-6EL		120	
	WLP-5-03		750	
Operating Temperature Range		T <sub>OPR</sub>	- 40 ~ + 85	°C
Storage Temperature Range		T <sub>STG</sub>	- 50 ~ +125	°C

## ELECTRICAL OPERATING CHARACTERISTICS

IXD3235/36/37 A series, V<sub>OUT</sub> = 1.8 V, T<sub>a</sub> = 25°C

PARAMETER		SYMBOL	CONDITIONS	MIN.	TYP.	MAX.	UNIT	CIRCUIT
Operating Voltage Range		V <sub>IN</sub>		2.0	-	6.0	V	①
Output Voltage		V <sub>OUT</sub>	V <sub>IN</sub> = V <sub>CE</sub> = 5.0 V, I <sub>OUT</sub> = 30 mA	1.764	1.800	1.836	V	
Maximum Output Current		I <sub>OUT_MAX</sub>	V <sub>IN</sub> = V <sub>OUT(E)</sub> + 2.0 V, V <sub>CE</sub> = 1.0 V <sup>9</sup>	600			mA	①
UVLO Voltage		V <sub>UVLO</sub>	V <sub>CE</sub> = V <sub>IN</sub> , V <sub>OUT</sub> = 0 <sup>1), 11)</sup>	1.00	1.40	1.78	V	④
Supply Current	IXD323xA18Cxx	I <sub>Q</sub>	V <sub>IN</sub> = V <sub>CE</sub> = 5.0 V, V <sub>OUT</sub> = V <sub>OUT(E)</sub> x 1.1 V		15	33	μA	①
	IXD323xA18Dxx				21	35		
Standby Current		I <sub>STB</sub>	V <sub>IN</sub> = 5.0 V, V <sub>CE</sub> = 0 V, V <sub>OUT</sub> = V <sub>OUT(E)</sub> x 1.1 V		0	1.0	μA	③
Oscillation Frequency	IXD323xA18Cxx	f <sub>OSC</sub>	V <sub>IN</sub> = V <sub>OUT(E)</sub> + 2 V, V <sub>CE</sub> = 1.0 V, I <sub>OUT</sub> = 100 mA	1020	1220	1380	kHz	②
	IXD323xA18Dxx			2550	3000	3460		
PFM Switching Current	IXD323xA18Cxx	I <sub>PFM</sub> <sup>12)</sup>	V <sub>IN</sub> = V <sub>CE</sub> = V <sub>OUT(E)</sub> + 2 V, I <sub>OUT</sub> = 1 mA (see table A)	120	160	200	mA	
	IXD323xA18Dxx			170	220	270		
P-channel ON time maximum		t <sub>PON_MAX</sub> <sup>12)</sup>	V <sub>IN</sub> = V <sub>CE</sub> = (see table B), I <sub>OUT</sub> = 1 mA		2D <sub>max</sub>	3D <sub>MAX</sub>		
Maximum Duty Cycle Ratio		D <sub>MAX</sub>	V <sub>IN</sub> = V <sub>CE</sub> = 5.0 V, V <sub>OUT</sub> = V <sub>OUT(E)</sub> x 0.9 V	100			%	②
Minimum Duty Cycle Ratio		D <sub>MIN</sub>	V <sub>IN</sub> = V <sub>CE</sub> = 5.0 V, V <sub>OUT</sub> = V <sub>OUT(E)</sub> x 1.1 V			0	%	②
Efficiency <sup>2)</sup>	IXD323xA18Cxx	EFFI	V <sub>IN</sub> = V <sub>CE</sub> = V <sub>OUT(E)</sub> + 1.2 V, I <sub>OUT</sub> = 100 mA		92		%	⑧
	IXD323xA18Dxx				86			
L <sub>X</sub> "H" ON Resistance <sup>13)</sup>		R <sub>LXH1</sub>	V <sub>IN</sub> = V <sub>CE</sub> = 5.0 V, V <sub>OUT</sub> = 0 V, I <sub>LX</sub> = 100 mA		0.35	0.55	Ω	④
L <sub>X</sub> "H" ON Resistance <sup>23)</sup>		R <sub>LXH2</sub>	V <sub>IN</sub> = V <sub>CE</sub> = 3.6 V, V <sub>OUT</sub> = 0 V, I <sub>LX</sub> = 100 mA		0.42	0.67	Ω	④
L <sub>X</sub> "L" ON Resistance <sup>14)</sup>		R <sub>LXL1</sub>	V <sub>IN</sub> = V <sub>CE</sub> = 5.0 V		0.45	0.65	Ω	④
L <sub>X</sub> "L" ON Resistance <sup>24)</sup>		R <sub>LXL2</sub>	V <sub>IN</sub> = V <sub>CE</sub> = 3.6 V		0.52	0.77	Ω	④
L <sub>X</sub> "H" Leakage Current <sup>5)</sup>		I <sub>LXH</sub>	V <sub>IN</sub> = V <sub>CE</sub> = 5.0 V, V <sub>OUT</sub> = 0 V, V <sub>LX</sub> = 5.0 V		0.01	1.0	μA	⑥
L <sub>X</sub> "L" Leakage Current <sup>5)</sup>		I <sub>LXH</sub>	V <sub>IN</sub> = V <sub>CE</sub> = 5.0 V, V <sub>OUT</sub> = 0 V, V <sub>LX</sub> = 5.0 V		0.01	1.0	μA	⑥
Current Limit <sup>10)</sup>		I <sub>LIM</sub>	V <sub>IN</sub> = V <sub>CE</sub> = 5.0 V, V <sub>OUT</sub> = V <sub>OUT(E)</sub> x 0.9 V <sup>8)</sup>	900	1050	1350	mA	
Output Voltage Temperature Characteristics		$\frac{\Delta V_{OUT}}{V_{OUT} * \Delta T_{OPR}}$	-40°C ≤ T <sub>OPR</sub> ≤ 85°C, I <sub>OUT</sub> = 30 mA		±100		ppm/°C	②
CE "H" Voltage <sup>14)</sup>		V <sub>CEH</sub>	V <sub>OUT</sub> = 0 V	0.65		6.0	V	④
CE "L" Voltage <sup>15)</sup>		V <sub>CEL</sub>	V <sub>OUT</sub> = 0 V	0		0.25	V	④
PWM mode Start Voltage <sup>6), 13)</sup>		V <sub>PWM</sub>	I <sub>OUT</sub> = 1 mA			V <sub>IN</sub> - 1.0		
PWM/PFM mode Start Voltage <sup>6), 13)</sup>		V <sub>PFM</sub>	I <sub>OUT</sub> = 1 mA	V <sub>IN</sub> - 0.25				
CE "H" Current		I <sub>ENH</sub>	V <sub>IN</sub> = V <sub>CE</sub> = 5.0 V, V <sub>OUT</sub> = 0 V	-0.1		0.1	μA	⑥

CE "L" Current		$I_{ENL}$	$V_{IN} = 5.0\text{ V}, V_{CE} = 0\text{ V}, V_{OUT} = 0\text{ V}$	-0.1		0.1	$\mu\text{A}$	⊙
Soft-Start Time	IXD323xA18Cxx	$t_{SS}$	$I_{OUT} = 1\text{ mA}$ (see table C)	0.5	1.0	2.5	ms	⊙
	IXD323xA18Dxx			0.5	0.9	2.5		
Latch Time <sup>7)</sup>		$t_{LAT}$	$V_{IN} = V_{CE} = 5.0\text{ V}, V_{OUT} = 0.8 \times V_{OUT(E)}, L_X$ short with 1 $\Omega$ resistor to ground	1.0		20.0	ms	
Short Protection Threshold Voltage		$V_{SHORT}$	$V_{IN} = V_{CE} = 5.0\text{ V}, L_X$ short with 1 $\Omega$ resistor to ground	0.675	0.900	1.150	V	

NOTE:

Test conditions: Unless otherwise stated,  $V_{IN} = 5.0\text{ V}, V_{OUT(E)} = \text{Nominal Voltage}$

- 1) Including hysteresis operating voltage range
- 2)  $EFFI = \{(\text{output voltage} \times \text{output current}) / (\text{input voltage} \times \text{input current})\} \times 100\%$
- 3)  $ON\text{ resistance } (\Omega) = (V_{IN} - L_X\text{ pin measurement voltage}) / 100\text{mA}$
- 4) Design target value
- 5) A 10 $\mu\text{A}$  (maximum) current may leak at high temperature
- 6) The CE/MODE pin of the IXD3237A series functions also as an external switching pin between PWM and PWM/PFM control. Control is switched to the automatic PWM/PFM switching mode when the CE/MODE pin voltage is equal to or greater than  $V_{IN}$  minus 0.3 V, and to the PWM mode when the CE/MODE pin voltage is equal to or lower than  $V_{IN}$  minus 1.0V. However, it should be equal to or greater than  $V_{CEH}$
- 7) Time from moment when  $V_{OUT}$  is shorted to GND via 1  $\Omega$  resistor to the moment, when Current Limit generates pulse stopping  $L_X$  oscillations
- 8) When  $V_{IN}$  is less than 2.4 V, current limit may not be reached because of voltage drop across ON resistance
- 9) When the difference between input and output voltage is small, some cycles may be skipped completely before current maximizes. If load current increases in this state, output voltage will decrease because of the voltage drop across P-channel transistor
- 10) Current limit denotes the level of an inductor peak current
- 11) Voltage, when  $L_X$  pin voltage is "L" = +0.1 V ~ -0.1 V
- 12) Not for IXD3235 series, because they have PWM mode only
- 13) The IXD3237 series only
- 14) Voltage at which  $L_X$  pin state changes from "L" to "H" =  $V_{IN} \sim V_{IN} - 1.2\text{ V}$
- 15) Voltage at which  $L_X$  pin state changes from "H" to "L" = +0.1 V ~ -0.1 V

## ELECTRICAL OPERATING CHARACTERISTICS (CONTINUED)

IXD3235/36/37 B/C/E/G series,  $V_{OUT} = 1.8\text{ V}$ ,  $T_a = 25^\circ\text{C}$

PARAMETER		SYMBOL	CONDITIONS	MIN.	TYP.	MAX.	UNIT	CIRCUIT	
Operating Voltage Range	B/C series	$V_{IN}$		2.0	-	6.0	V	①	
	E/G series			1.8		6.0			
Output Voltage		$V_{OUT}$	$V_{IN} = V_{CE} = 5.0\text{ V}$ , $I_{OUT} = 30\text{ mA}$	1.764	1.800	1.836	V		
Maximum Output Current		$I_{OUT\_MAX}$	$V_{IN} = V_{OUT(E)} + 2.0\text{ V}$ , $V_{CE} = 1.0\text{ V}^{(9)}$	600			mA	①	
UVLO Voltage		$V_{UVLO}$	$V_{CE} = V_{IN}$ , $V_{OUT} = V_{OUT(E)} \times 0.5\text{ V}^{(1), (11), (16)}$	1.00	1.40	1.78	V	④	
Supply Current	IXD323xx18Cxx	$I_Q$	$V_{IN} = V_{CE} = 5.0\text{ V}$ , $V_{OUT} = V_{OUT(E)} \times 1.1\text{ V}$		15	33	$\mu\text{A}$	①	
	IXD323xx18Dxx				21	35			
Standby Current		$I_{STB}$	$V_{IN} = 5.0\text{ V}$ , $V_{CE} = 0\text{ V}$ , $V_{OUT} = V_{OUT(E)} \times 1.1\text{ V}$		0	1.0	$\mu\text{A}$	③	
Oscillation Frequency	IXD323xx18Cxx	$f_{OSC}$	$V_{IN} = V_{OUT(E)} + 2\text{ V}$ , $V_{CE} = 1.0\text{ V}$ , $I_{OUT} = 100\text{ mA}$	1020	1220	1380	kHz	②	
	IXD323xx18Dxx			2550	3000	3460			
PFM Switching Current	IXD323xx18Cxx	$I_{PFM}^{(12)}$	$V_{IN} = V_{CE} = V_{OUT(E)} + 2\text{ V}$ , $I_{OUT} = 1\text{ mA}$ (see table A)	120	160	200	mA		
	IXD323xx18Dxx			170	220	270			
P-channel ON time maximum		$t_{PON\_MAX}^{(12)}$	$V_{IN} = V_{CE} =$ (see table B), $I_{OUT} = 1\text{ mA}$		$2D_{max}$	$3D_{MAX}$			
Maximum Duty Cycle Ratio		$D_{MAX}$	$V_{IN} = V_{CE} = 5.0\text{ V}$ , $V_{OUT} = V_{OUT(E)} \times 0.9\text{ V}$	100			%	②	
Minimum Duty Cycle Ratio		$D_{MIN}$	$V_{IN} = V_{CE} = 5.0\text{ V}$ , $V_{OUT} = V_{OUT(E)} \times 1.1\text{ V}$			0	%	②	
Efficiency <sup>2)</sup>	IXD323xx18Cxx	EFFI	$V_{IN} = V_{CE} = V_{OUT(E)} + 1.2\text{ V}$ , $I_{OUT} = 100\text{ mA}$		92		%	⑧	
	IXD323xx18Dxx				86				
L <sub>x</sub> "H" ON Resistance 1 <sup>3)</sup>		$R_{LXH1}$	$V_{IN} = V_{CE} = 5.0\text{ V}$ , $V_{OUT} = 0\text{ V}$ , $I_{LX} = 100\text{ mA}$		0.35	0.55	$\Omega$	④	
L <sub>x</sub> "H" ON Resistance 2 <sup>3)</sup>		$R_{LXH2}$	$V_{IN} = V_{CE} = 3.6\text{ V}$ , $V_{OUT} = 0\text{ V}$ , $I_{LX} = 100\text{ mA}$		0.42	0.67	$\Omega$	④	
L <sub>x</sub> "L" ON Resistance 1 <sup>4)</sup>		$R_{LXL1}$	$V_{IN} = V_{CE} = 5.0\text{ V}$		0.45	0.65	$\Omega$	④	
L <sub>x</sub> "L" ON Resistance 2 <sup>4)</sup>		$R_{LXL2}$	$V_{IN} = V_{CE} = 3.6\text{ V}$		0.52	0.77	$\Omega$	④	
L <sub>x</sub> "H" Leakage Current <sup>5)</sup>		$I_{LXH}$	$V_{IN} = V_{CE} = 5.0\text{ V}$ , $V_{OUT} = 0\text{ V}$ , $V_{LX} = 5.0\text{ V}$		0.01	1.0	$\mu\text{A}$	⑥	
L <sub>x</sub> "L" Leakage Current <sup>5)</sup>		$I_{LXL}$	$V_{IN} = V_{CE} = 5.0\text{ V}$ , $V_{OUT} = 0\text{ V}$ , $V_{LX} = 5.0\text{ V}$		0.01	1.0	$\mu\text{A}$	⑥	
Current Limit <sup>10)</sup>		$I_{LIM}$	$V_{IN} = V_{CE} = 5.0\text{ V}$ , $V_{OUT} = V_{OUT(E)} \times 0.9\text{ V}^{(8)}$	900	1050	1350	mA		
Output Voltage Temperature Characteristics		$\frac{\Delta V_{OUT}}{V_{OUT} * \Delta T_{OPR}}$	$-40^\circ\text{C} \leq T_{OPR} \leq 85^\circ\text{C}$ , $I_{OUT} = 30\text{ mA}$		$\pm 100$		ppm/ $^\circ\text{C}$	②	
CE "H" Voltage <sup>14)</sup>		$V_{CEH}$	$V_{OUT} = 0\text{ V}$	0.65		6.0	V	④	
CE "L" Voltage <sup>15)</sup>		$V_{CEL}$	$V_{OUT} = 0\text{ V}$	0		0.25	V	④	
PWM mode Start Voltage <sup>6), (13)</sup>		$V_{PWM}$	$I_{OUT} = 1\text{ mA}$			$V_{IN} - 1.0$			
PWM/PFM mode Start Voltage <sup>6), (13)</sup>		$V_{PFM}$	$I_{OUT} = 1\text{ mA}$	$V_{IN} - 0.25$					
CE "H" Current		$I_{ENH}$	$V_{IN} = V_{CE} = 5.0\text{ V}$ , $V_{OUT} = 0\text{ V}$	-0.1		0.1	$\mu\text{A}$	⑥	
CE "L" Current		$I_{ENL}$	$V_{IN} = 5.0\text{ V}$ , $V_{CE} = 0\text{ V}$ , $V_{OUT} = 0\text{ V}$	-0.1		0.1	$\mu\text{A}$	⑥	
Soft-Start Time	IXD323xB(G)18Cxx	$t_{SS}$	$I_{OUT} = 1\text{ mA}$ (see table C)		0.25	0.4	ms	②	
	IXD323xC(E)18Cxx				0.5	1.0			2.5
	IXD323xB(G)18Dxx					0.32			0.50
	IXD323xC(E)18Dxx				0.5	0.9			2.5
Latch Time <sup>7)</sup>		$t_{LAT}$	$V_{IN} = V_{CE} = 5.0\text{ V}$ , $V_{OUT} = 0.8 \times V_{OUT(E)}$ , L <sub>x</sub> short with 1 $\Omega$ resistor to ground	1.0		20.0	ms		
Short Protection Threshold Voltage	B/C series	$V_{SHORT}$	$V_{IN} = V_{CE} = 5.0\text{ V}$ , L <sub>x</sub> short with 1 $\Omega$ resistor to ground	0.675	0.900	1.150	V		
	E/G series			0.338	0.450	0.563			
C <sub>L</sub> Discharge Resistance		$R_{DCL}$	$V_{IN} = V_{LX} = 5.0\text{ V}$ , $V_{CE} = 0\text{ V}$ , $V_{OUT} - \text{open}$	200	300	450	$\Omega$		

**NOTE:**

Test conditions: Unless otherwise stated,  $V_{IN} = 5.0\text{ V}$ ,  $V_{OUT(E)} = \text{Nominal Voltage}$

- Including hysteresis operating voltage range
- $EFFI = \{(\text{output voltage} \times \text{output current}) / (\text{input voltage} \times \text{input current})\} \times 100\%$
- ON resistance ( $\Omega$ ) =  $(V_{IN} - L_x \text{ pin measurement voltage}) / 100\text{mA}$
- Design target value

- 5) A 10 $\mu$ A (maximum) current may leak at high temperature
- 6) The CE/MODE pin of the IXD3237A series functions also as an external switching pin between PWM and PWM/PFM control. Control is switched to the automatic PWM/PFM switching mode when the CE/MODE pin voltage is equal to or greater than  $V_{IN}$  minus 0.3 V, and to the PWM mode when the CE/MODE pin voltage is equal to or lower than  $V_{IN}$  minus 1.0V. However, it should be equal to or greater than  $V_{CEH}$
- 7) Time from moment when  $V_{OUT}$  is shorted to GND via 1  $\Omega$  resistor to the moment, when Current Limit generates pulse stopping  $L_x$  oscillations
- 8) When  $V_{IN}$  is less than 2.4 V, current limit may not be reached because of voltage drop across ON resistance
- 9) When the difference between input and output voltage is small, some cycles may be skipped completely before current maximizes. If load current increases in this state, output voltage will decrease because of the voltage drop across P-channel transistor
- 10) Current limit denotes the level of an inductor peak current
- 11) Voltage, when  $L_x$  pin voltage is "L" = +0.1 V ~ -0.1 V
- 12) Not for IXD3235 series, because they have PWM mode only
- 13) The IXD3237 series only
- 14) Voltage at which  $L_x$  pin state changes from "L" to "H" =  $V_{IN} - V_{IN} - 1.2$  V"
- 15) Voltage at which  $L_x$  pin state changes from "H" to "L" = +0.1 V ~ -0.1 V
- 16) Voltage at which  $V_{OUT}$  becomes more than  $V_{IN}$ , while  $V_{IN}$  is rising from 0 V to  $V_{OUT(E)} \times 0.5$  V

## ELECTRICAL OPERATING CHARACTERISTICS (CONTINUED)

IXD3235/36/37 D/F series,  $V_{OUT} = 1.8\text{ V}$ ,  $T_a = 25^\circ\text{C}$

PARAMETER		SYMBOL	CONDITIONS	MIN.	TYP.	MAX.	UNIT	CIRCUIT
Operating Voltage Range		$V_{IN}$		1.8	-	6.0	V	①
FB Voltage		$V_{FB}$	$V_{IN} = V_{CE} = 5.0\text{ V}$ , $I_{OUT} = 30\text{ mA}$	1.784	1.800	1.816	V	
Maximum Output Current		$I_{OUT\_MAX}$	$V_{IN} = V_{OUT(E)} + 2.0\text{ V}$ , $V_{CE} = 1.0\text{ V}^{(9)}$	600			mA	①
UVLO Voltage		$V_{UVLO}$	$V_{CE} = V_{IN}$ , $V_{OUT} = 0^{(1), (11)}$	1.00	1.40	1.78	V	④
Supply Current	IXD323xx18Cxx	$I_Q$	$V_{IN} = V_{CE} = 5.0\text{ V}$ , $V_{OUT} = V_{OUT(E)} \times 1.1\text{ V}$		15		$\mu\text{A}$	①
	IXD323xx18Dxx				21	35		
Standby Current		$I_{STB}$	$V_{IN} = 5.0\text{ V}$ , $V_{CE} = 0\text{ V}$ , $V_{OUT} = V_{OUT(E)} \times 1.1\text{ V}$		0	1.0	$\mu\text{A}$	③
Oscillation Frequency	IXD323xx18Cxx	$f_{OSC}$	$V_{IN} = V_{OUT(E)} + 2\text{ V}$ , $V_{CE} = 1.0\text{ V}$ , $I_{OUT} = 100\text{ mA}$	1020	1220	1380	kHz	②
	IXD323xx18Dxx			2550	3000	3460		
PFM Switching Current	IXD323xx18Cxx	$I_{PFM}^{(12)}$	$V_{IN} = V_{CE} = V_{OUT(E)} + 2\text{ V}$ , $I_{OUT} = 1\text{ mA}$ (see table A)	120	160	200	mA	
	IXD323xx18Dxx			170	220	270		
P-channel ON time maximum		$t_{PON\_MAX}^{(12)}$	$V_{IN} = V_{CE} =$ (see table B), $I_{OUT} = 1\text{ mA}$		$2D_{max}$	$3D_{MAX}$		
Maximum Duty Cycle Ratio		$D_{MAX}$	$V_{IN} = V_{CE} = 5.0\text{ V}$ , $V_{OUT} = V_{OUT(E)} \times 0.9\text{ V}$	100			%	②
Minimum Duty Cycle Ratio		$D_{MIN}$	$V_{IN} = V_{CE} = 5.0\text{ V}$ , $V_{OUT} = V_{OUT(E)} \times 1.1\text{ V}$			0	%	②
Efficiency <sup>2)</sup>	IXD323xx18Cxx	EFFI	$V_{IN} = V_{CE} = V_{OUT(E)} + 1.2\text{ V}$ , $I_{OUT} = 100\text{ mA}$		92		%	⑧
	IXD323xx18Dxx				86			
$L_X$ "H" ON Resistance 1 <sup>3)</sup>		$R_{LXH1}$	$V_{IN} = V_{CE} = 5.0\text{ V}$ , $V_{OUT} = 0\text{ V}$ , $I_{LX} = 100\text{ mA}$		0.35	0.55	$\Omega$	④
$L_X$ "H" ON Resistance 2 <sup>3)</sup>		$R_{LXH2}$	$V_{IN} = V_{CE} = 3.6\text{ V}$ , $V_{OUT} = 0\text{ V}$ , $I_{LX} = 100\text{ mA}$		0.42	0.67	$\Omega$	④
$L_X$ "L" ON Resistance 1 <sup>4)</sup>		$R_{LXL1}$	$V_{IN} = V_{CE} = 5.0\text{ V}$		0.45	0.65	$\Omega$	④
$L_X$ "L" ON Resistance 2 <sup>4)</sup>		$R_{LXL2}$	$V_{IN} = V_{CE} = 3.6\text{ V}$		0.52	0.77	$\Omega$	④
$L_X$ "H" Leakage Current <sup>5)</sup>		$I_{LXH}$	$V_{IN} = V_{CE} = 5.0\text{ V}$ , $V_{OUT} = 0\text{ V}$ , $V_{LX} = 5.0\text{ V}$		0.01	1.0	$\mu\text{A}$	⑥
$L_X$ "L" Leakage Current <sup>5)</sup>		$I_{LXH}$	$V_{IN} = V_{CE} = 5.0\text{ V}$ , $V_{OUT} = 0\text{ V}$ , $V_{LX} = 5.0\text{ V}$		0.01	1.0	$\mu\text{A}$	⑥
Current Limit <sup>10)</sup>		$I_{LIM}$	$V_{IN} = V_{CE} = 5.0\text{ V}$ , $V_{OUT} = V_{OUT(E)} \times 0.9\text{ V}^{(8)}$	900	1050	1350	mA	
Output Voltage Temperature Characteristics		$\frac{\Delta V_{OUT}}{V_{OUT} * \Delta T_{OPR}}$	$-40^\circ\text{C} \leq T_{OPR} \leq 85^\circ\text{C}$ , $I_{OUT} = 30\text{ mA}$		$\pm 100$		ppm/ $^\circ\text{C}$	②
CE "H" Voltage <sup>14)</sup>		$V_{CEH}$	$V_{OUT} = 0\text{ V}$	0.65		6.0	V	④
CE "L" Voltage <sup>15)</sup>		$V_{CEL}$	$V_{OUT} = 0\text{ V}$	0		0.25	V	④
PWM mode Start Voltage <sup>6), (13)</sup>		$V_{PWM}$	$I_{OUT} = 1\text{ mA}$			$V_{IN} - 1.0$		
PWM/PFM mode Start Voltage <sup>6), (13)</sup>		$V_{PFM}$	$I_{OUT} = 1\text{ mA}$		$V_{IN} - 0.25$			
CE "H" Current		$I_{ENH}$	$V_{IN} = V_{CE} = 5.0\text{ V}$ , $V_{OUT} = 0\text{ V}$	-0.1		0.1	$\mu\text{A}$	⑥
CE "L" Current		$I_{ENL}$	$V_{IN} = 5.0\text{ V}$ , $V_{CE} = 0\text{ V}$ , $V_{OUT} = 0\text{ V}$	-0.1		0.1	$\mu\text{A}$	⑥
Soft-Start Time	IXD323xD18Cxx	$t_{SS}$	$I_{OUT} = 1\text{ mA}$ (see table C)	0.5	1.0	2.5	ms	②
	IXD323xF18Cxx				0.25	0.40		
	IXD323xD18Dxx			0.5	1.0	2.5		
	IXD323xF18Dxx				0.25	0.40		
Latch Time <sup>7)</sup>		$t_{LAT}$	$V_{IN} = V_{CE} = 5.0\text{ V}$ , $V_{OUT} = 0.8 \times V_{OUT(E)}$ , $L_X$ short with $1\ \Omega$ resistor to ground	1.0		20.0	ms	
Short Protection Threshold Voltage		$V_{SHORT}$	$V_{IN} = V_{CE} = 5.0\text{ V}$ , $L_X$ short with $1\ \Omega$ resistor to ground	0.675	0.900	1.150	V	
$C_L$ Discharge Resistance		$R_{DCL}$	$V_{IN} = V_{LX} = 5.0\text{ V}$ , $V_{CE} = 0\text{ V}$ , $V_{OUT} - \text{open}$	200	300	450	$\Omega$	

**NOTE:**

Test conditions: Unless otherwise stated,  $V_{IN} = 5.0\text{ V}$ ,  $V_{OUT(E)} = \text{Nominal Voltage}$

- 1) Including hysteresis operating voltage range
- 2)  $EFFI = \{(\text{output voltage} \times \text{output current}) / (\text{input voltage} \times \text{input current})\} \times 100\%$
- 3) ON resistance ( $\Omega$ ) =  $(V_{IN} - L_X \text{ pin measurement voltage}) / 100\text{mA}$
- 4) Design target value
- 5) A  $10\ \mu\text{A}$  (maximum) current may leak at high temperature

- 6) The CE/MODE pin of the IXD3237A series functions also as an external switching pin between PWM and PWM/PFM control. Control is switched to the automatic PWM/PFM switching mode when the CE/MODE pin voltage is equal to or greater than  $V_{IN}$  minus 0.3 V, and to the PWM mode when the CE/MODE pin voltage is equal to or lower than  $V_{IN}$  minus 1.0V. However, it should be equal to or greater than  $V_{CEH}$
- 7) Time from moment when  $V_{OUT}$  is shorted to GND via 1  $\Omega$  resistor to the moment, when Current Limit generates pulse stopping  $L_x$  oscillations
- 8) When  $V_{IN}$  is less than 2.4 V, current limit may not be reached because of voltage drop across ON resistance
- 9) When the difference between input and output voltage is small, some cycles may be skipped completely before current maximizes. If load current increases in this state, output voltage will decrease because of the voltage drop across P-channel transistor
- 10) Current limit denotes the level of an inductor peak current
- 11) Voltage, when  $L_x$  pin voltage is "L" = +0.1 V ~ -0.1 V
- 12) Not for IXD3235 series, because they have PWM mode only
- 13) The IXD3237 series only
- 14) Voltage at which  $L_x$  pin state changes from "L" to "H" =  $V_{IN} \sim V_{IN} - 1.2$  V"
- 15) Voltage at which  $L_x$  pin state changes from "H" to "L" = +0.1 V ~ -0.1 V

**TABLE A**

PFM Switching Current ( $I_{PFM}$ ) vs. Oscillation Frequency and Setting Voltage

SETTING VOLTAGE	$f_{osc} = 1.2$ MHz			$f_{osc} = 3.0$ MHz		
	MIN	TYP	MAX	MIN	TYP	MAX
$V_{OUT(E)} \leq 1.2$ V	140	180	240	190	260	350
$1.2$ V < $V_{OUT(E)} \leq 1.75$ V	130	170	220	180	240	300
$V_{OUT(E)} \geq 1.8$ V	120	160	200	170	220	270

**TABLE B**

Input Voltage ( $V_{IN}$ ) for Measuring P-channel ON time maximum  $t_{PON\_MAX}$

$f_{osc}$	1,2 MHz	3 MHz
$V_{IN}$	$V_{OUT(E)} + 0.5$ V	$V_{OUT(E)} + 1.0$ V

**NOTE:**

Example:

When  $V_{OUT(E)} = 1.2$ V and  $f_{osc} = 1.2$  MHz,  $V_{IN}$  should be 1.7 V, however,  $V_{IN}$  should be at least 2.0 V if the minimum operating voltage is 2.0 V

**TABLE C**

Soft-Start Time vs. Setting Voltage and Oscillation Frequency (IXD3235/36/37 B and G Series only)

SERIES	$f_{osc}$	SETTING VOLTAGE, V	SOFT START TIME, $\mu$ S		
			MIN	TYP	MAX
IXD3235B/G IXD3237B/G	1.2 MHz	$0.8 \leq V_{OUT(E)} < 1.75$		250	400
		$1.5 \leq V_{OUT(E)} < 1.8$		320	500
		$1.8 \leq V_{OUT(E)} < 2.5$		250	400
		$2.5 \leq V_{OUT(E)} < 4.0$		320	500
IXD3236B/G		$0.8 \leq V_{OUT(E)} < 2.5$		250	400
		$2.5 \leq V_{OUT(E)} < 4.0$		320	500
IXD3235/36/37 B/G	3.0 MHz	$0.8 \leq V_{OUT(E)} < 1.8$		250	400
		$1.8 \leq V_{OUT(E)} < 4.0$		320	500

## PIN CONFIGURATION

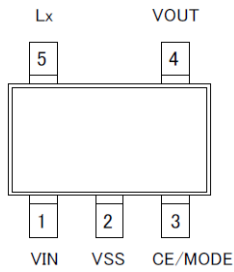

SOT-25 (Top View)

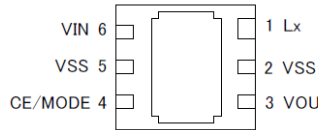

USP-6C (Bottom View)

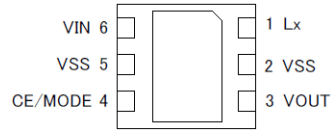

USP-6EL (Bottom View)

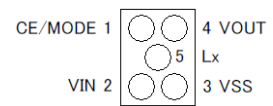

WLP-5-03 (Bottom View)

### NOTE:

The dissipation pad for the USP-6C and USP-6EL packages should be soldered in recommended mount pattern and metal masking to enhance mounting strength and heat release. If the pad needs to be connected to other pins, it should be connected to the  $V_{SS}$  (No 2 and No 5) pins.  $V_{SS}$  pins (No. 2 and 5) should be tied together.

## PIN ASSIGNMENT

PIN NUMBER			PIN NAME	FUNCTIONS
SOT-25	USP-6C/USP-6EL	WLP-5-03		
1	6	2	$V_{IN}$	Power Input
2	2, 5	3	$V_{SS}$	Ground
3	4	1	CE/MODE	Enable (Active HIGH), Mode Selection Pin
4	3	4	$V_{OUT}$ (FB)	Fixed Output Voltage - A/B/C/E/G series (Output Voltage Sense Pin - D/F series)
5	1	5	$L_X$	Switching Node



**BLOCK DIAGRAMS**

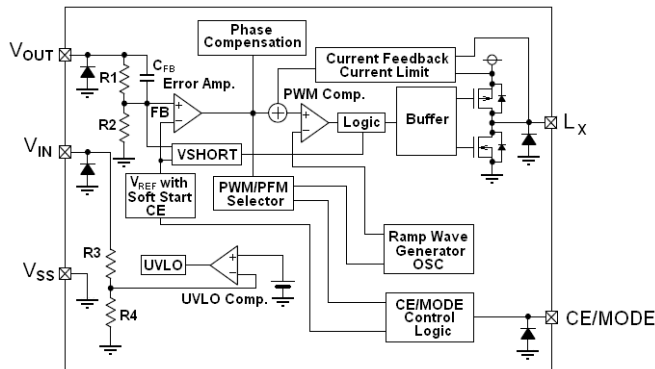

IXD3235/36/37 A Series

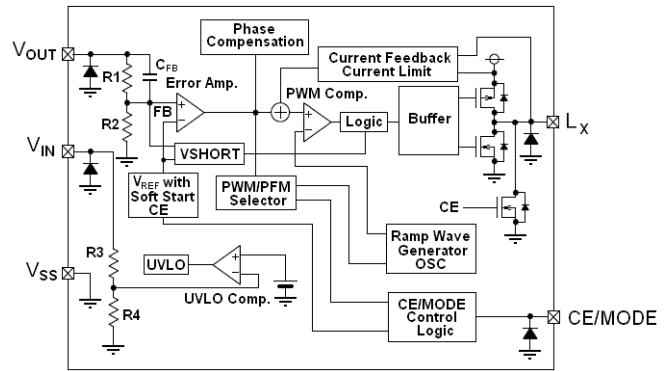

IXD3235/36/37 B/C/E/G Series

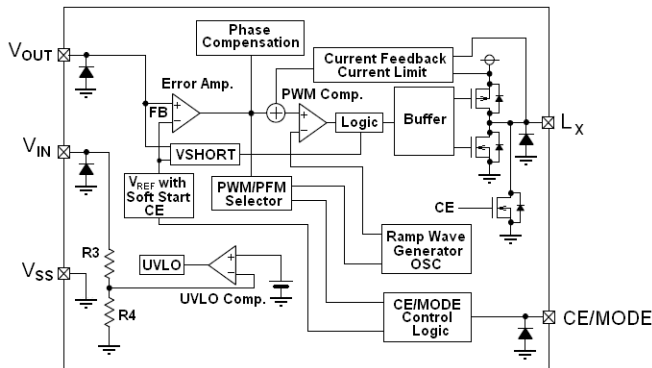

IXD3235/36/37 D/F Series

Internal diodes include an ESD protection and a parasitic diode

**BASIC OPERATION**

The IXD3235/36/37 series consists of a Reference Voltage source, Ramp Wave Generator, Error Amplifier, PWM Comparator, Phase Compensation circuit, output voltage resistive divider, P-channel switching transistor, N-channel transistor for the synchronous switch, Current Limiter circuit, UVLO circuit, and others. (See the block diagram above.)

The Error Amplifier compares output voltage divided by internal (external for D/F versions) resistors  $R_{FB1}/R_{FB2}$  with the internal reference voltage. Amplified difference between these two signals applies to the one input of the PWM Comparator, while ramp voltage from the Ramp Wave Generator applies to the second input. Resulting PWM pulse determines switching transistor ON time. It goes through the Buffer and it appears at the gate of the internal P-channel switching transistor. This continuous process stabilizes output voltage.

The Current Feedback circuit monitors current of the P-channel transistor at each switching cycle, and modulates output signal from the Error Amplifier to provide additional feedback. This guarantees a stable converter operation even with low ESR ceramic load capacitor.

**Reference Voltage Source**

The Reference Voltage Source provides the reference voltage to ensure stable output voltage of the DC/DC converter.

**Ramp Wave Generator**

The Ramp Wave Generator produces ramp waveform signal needed for PWM operation, and signals to synchronize all the internal circuits. It operates at internally fixed 1.2 MHz or 3.0 MHz frequency.

## Error Amplifier

The Error Amplifier monitors output voltage through resistive divider connected to  $V_{OUT}$  (FB) pin. If output voltage falls below preset value and Error Amplifier's input signal becomes less than internal reference voltage, the Error Amplifier's output signal increases. That results in wider PWM pulse and respectively longer ON time for switching transistor to increase output voltage. The gain and frequency characteristics of the error amplifier output are fixed internally to optimize IC performance.

## Current Limiter

The Current Limiter circuit monitors current flowing through the P-channel transistor connected to the Lx pin, and combines function of the current limit and operation suspension.

When transistor's current is greater than a specified level, the Current Limiter turns off P-channel transistor immediately. After that, the Current Limiter turns off too, returning to monitoring mode.

The driver transistor turns on at the next cycle, but the Current Limiter will turn it off immediately if an over current exists. When the over current state is eliminated, the IC resumes its normal operation.

The IC waits for end of the over current state repeating above steps ( $t_1$  on figure below). If an over-current state continues for a few ms with IC repeatedly performing above steps, the Current Limiter latches the P-channel transistor in OFF state, and IC suspends operations ( $t_2$  on figure below). To restart IC operation after this condition, either EN pin should be toggled H – L – H, or  $V_{IN}$  pin voltage should be set below UVLO to resume operations from soft start.

The suspension mode is not a standby mode. In the suspension mode, pulse output is suspended; however, internal circuitries remain in operation mode consuming power.

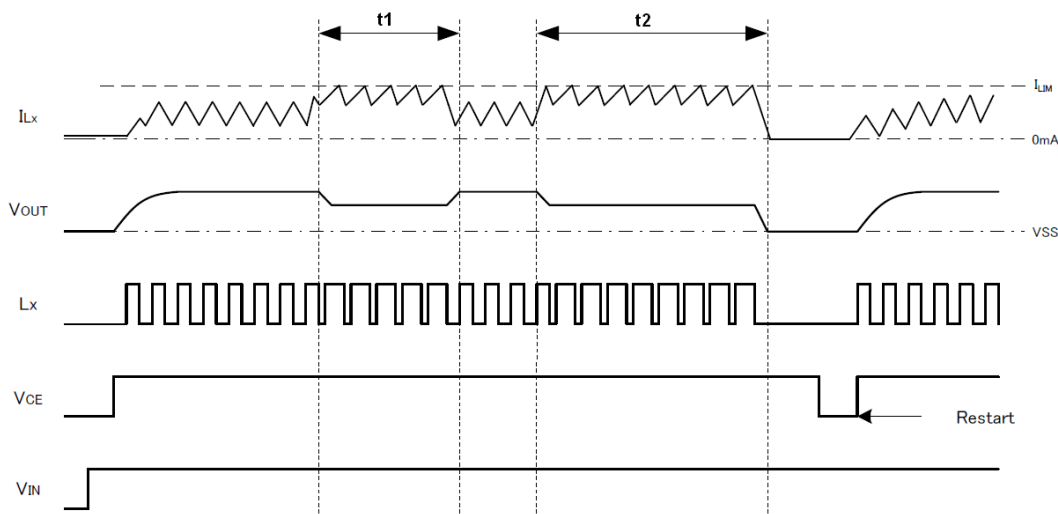

## Short-Circuit Protection

The short-circuit protection monitors the  $R_{FB1}/R_{FB2}$  divider voltage (FB point in the block diagram). If output is accidentally shorted to the ground, FB voltage starts falling. When this voltage becomes less than half of the reference voltage ( $V_{REF}$ ) and P-channel switching transistor's current is more than the  $I_{LIM}$  threshold, the Short-Circuit Protection turns off and latches quickly the P-channel transistor.

At D/E/F/G series, Short Circuit Protection starts once FB voltage becomes less than 0.25 of reference voltage ( $V_{REF}$ ), disregard to transistor's current.

To restart IC operation after this condition, either EN pin should be toggled H – L – H, or  $V_{IN}$  pin voltage should be set below UVLO to resume operations from soft start.

The sharp load transients creating a voltage drop at the  $V_{OUT}$ , propagate to the FB point through  $C_{FB}$ , that may result in Short Circuit protection operating at voltages higher than  $1/2 V_{REF}$  voltage.

## UVLO Circuit

When the  $V_{IN}$  pin voltage becomes 1.4V or lower, the P-channel transistor is forced OFF to prevent false pulse output caused by unstable operation of the internal circuitry. When the  $V_{IN}$  pin voltage becomes 1.8 V or higher, switching operations resume with the soft start. The soft start function operates even when the  $V_{IN}$  voltage falls

below the UVLO threshold for a very short time. The UVLO circuit does not cause a complete shutdown of the IC, but causes pulse output to be suspended; therefore, the internal circuitry remains in operation.

**PFM Switch Current**

In PFM mode, the IC keeps the P-channel transistor on until inductor current reaches a specified level ( $I_{PFM}$ ). P-channel transistor's ON time is equal

$$t_{ON} = L \times I_{PFM} / (V_{IN} - V_{OUT}), \mu S,$$

where L is an inductance in  $\mu H$ , and  $I_{PFM}$  is a current limit in A.

**PFM Duty Limit**

In PFM mode, P-channel ON time maximum ( $t_{PON\_MAX}$ ) is set to  $2D_{MAX}$ , i.e. two periods of the switching frequency. Therefore, under conditions, when the ON time increases (i.e. step-down ratio is small), it is possible that P-channel transistor to be turned off, even when inductor current does not reach to  $I_{PFM}$ . (See Figures 1 and 2 below)

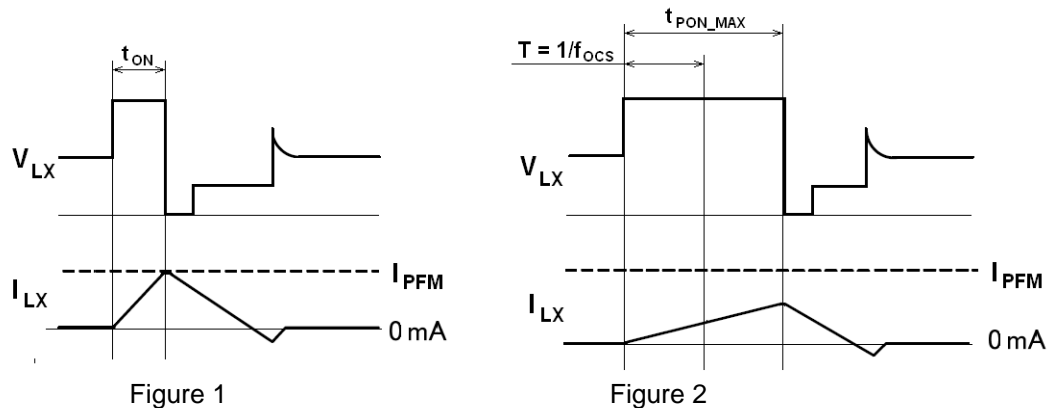

**C<sub>L</sub> High Speed Discharge**

The IXD3235/36/37 B, C, D, E, F, and G series can quickly discharge the output capacitor ( $C_L$ ) to avoid application malfunction, when CE pin set logic LOW to disable IC.

$C_L$  Discharge Time is proportional to the resistance (R) of the N-channel transistor located between the  $L_X$  pin and ground and the output  $C_L$  capacitance as shown below.

$$t_{DSH} = RC_L \times \ln (V_{OUT(E)} / V), \text{ where}$$

V - Output voltage after discharge

$V_{OUT(E)}$  - Output voltage

R = 300  $\Omega$  (Typical value)

**Output Voltage Discharge Characteristics**

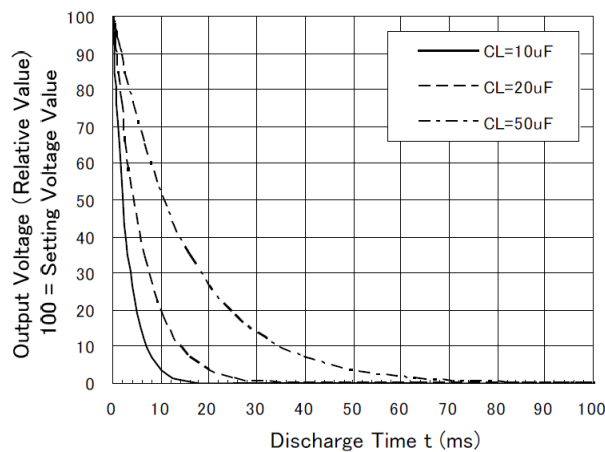

### CE/MODE Pin Function

The IXD3235/36/37 series enter the shut down mode, when a LOW logic-level signal applies to the CE/MODE pin. In the shutdown mode, IC current consumption is  $\sim 0 \mu\text{A}$  (Typical value), with the Lx and  $V_{\text{OUT}}$  pins at high impedance state. The IC starts its operation when a HIGH logic-level signal applies to the CE/MODE pin.

Intermediate voltage, generated by external resistive divider can be used to select PWM/PFM auto or PWM only switching modes in respect with the table below.

CE/MODE VOLTAGE LEVEL	OPERATION MODE		
	IXD3235	IXD3236	IXD3537
$0.65 \text{ V} \leq V_{\text{CE/MODE}} \leq 6.0 \text{ V}$	Synchronous Fixed PWM mode	Synchronous PWM/PFM auto switching mode	-
$V_{\text{IN}} - 0.25 \text{ V} \leq V_{\text{CE/MODE}} \leq V_{\text{IN}}$	-	-	Synchronous PWM/PFM auto switching mode
$0.65 \text{ V} \leq V_{\text{CE/MODE}} \leq V_{\text{IN}} - 1.0 \text{ V}$	-	-	Synchronous Fixed PWM mode
$0 \text{ V} \leq V_{\text{CE/MODE}} \leq 0.25 \text{ V}$	Standby mode	Standby mode	Standby mode

Examples of CE/MODE pin use are shown below. Please set the value of each resistor from few hundreds k $\Omega$  to few hundred M $\Omega$ . For switches, CPU open-drain I/O port and transistor can be used.

The CE/MODE pin is a CMOS input with a sink current  $\sim 0 \mu\text{A}$ .

### IXD3235/36 series - Examples of how to use CE/MODE pin

SW-CE POSITION	IC STATUS	
	SCHEMATIC A	SCHEMATIC B
ON	Standby	Active
OFF	Active	Standby

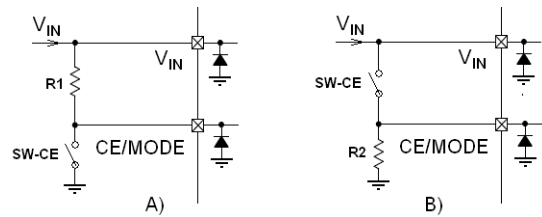

### IXD3237 series - Examples of how to use CE/MODE pin

SW-CE POSITION	SW-PWM/PFM POSITION	IC STATUS	
		SCHEMATIC A	SCHEMATIC B
ON	X	Standby	PWM/PFM Auto Switching Mode
OFF	ON	PWM Mode	PWM Mode
OFF	OFF	PWM/PFM Auto Switching Mode	Standby

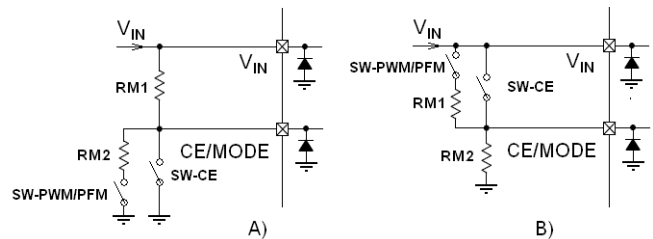

### Soft Start

Soft start time is available in two options via product selection.

The soft-start time of IXD3235/36/37 series is optimized by using internal circuits and it is 1.0 ms (Typically.) for A/C/D/E series and 0.25 ms for B/F/G series. D and F series require external resistors and a capacitor to set the output voltage, so the soft-start time might vary based on value of those external components. The definition of the soft-start time is the time when the output voltage goes up to the 90% of nominal output voltage after the IC is enabled by CE "H" signal.

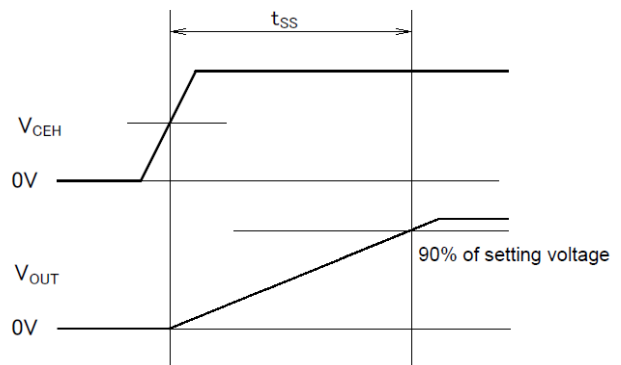

## TYPICAL APPLICATION CIRCUITS

IXD3235/36/37 A, B, C, E, G

Series (Fixed Output Voltage)

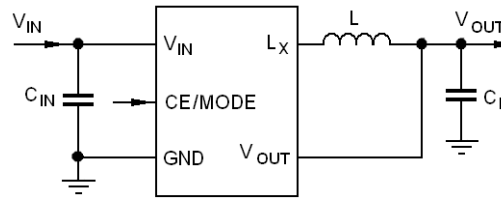

IXD3235/36/37 D, F Series (Adjustable Output Voltage)

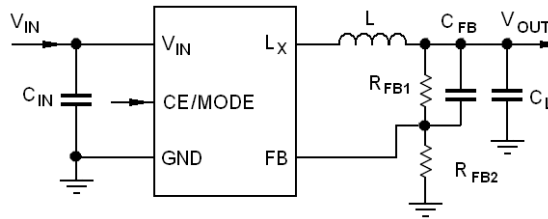

## EXTERNAL COMPONENTS

$f_{osc}$	1.2 MHz	3.0 MHz
L, $\mu H$	4.7	1.5
$C_{IN}$ , $\mu F$	4.7	4.7
$C_L$ , $\mu F$	10	10

### Setting Output Voltage

The IXD3235/36/37 D, F Series allows set output voltage externally by two resistors  $R_{FB1}$  and  $R_{FB2}$  as shown on schematic diagram above.

Output voltage can be set starting from 0.9V. However, when input voltage ( $V_{IN}$ ) is lower than the set output voltage, output voltage ( $V_{OUT}$ ) cannot be higher than the input voltage.

$$V_{OUT} = 0.8 \times (R_{FB1} + R_{FB2}) / R_{FB2}$$

$$R_{FB1} + R_{FB2} < 1 \text{ M}\Omega.$$

The value of the phase compensation capacitor  $C_{FB}$  is calculated by the follow equation

$$f_{ZFB} = 1 / (2 \times \pi \times C_{FB} \times R_{FB1}),$$

where  $f_{ZFB} < 10 \text{ kHz}$ . For optimization,  $f_{ZFB}$  can be adjusted in the range of 1 kHz to 20 kHz depending on the inductance L and the load capacitance  $C_L$ .

Example:

When  $R_{FB1} = 470 \text{ k}\Omega$  and  $R_{FB2} = 150 \text{ k}\Omega$ ,  $V_{OUT} = 0.8 \times (470 \text{ k} + 150 \text{ k}) / 150 \text{ k} = 3.3 \text{ V}$

$V_{OUT}$ , V	$R_{FB1}$ , k $\Omega$	$R_{FB2}$ , k $\Omega$	$C_{FB}$ , pF
0.9	100	820	150
1.2	150	300	100
1.5	130	150	220
1.8	300	240	150

$V_{OUT}$ , V	$R_{FB1}$ , k $\Omega$	$R_{FB2}$ , k $\Omega$	$C_{FB}$ , pF
2.5	510	240	100
3.0	330	120	150
3.3	470	150	100
4.0	120	30	470

## LAYOUT AND USE CONSIDERATIONS

1. Wire external components as close to the IC as possible and use thick, short connecting traces to reduce the circuit impedance. Please, pay special attention to the  $V_{IN}$  and GND wiring. Switching noise, which occurs from the GND, may cause the instability of the IC, so, position  $V_{IN}$  and  $V_{CL}$  capacitors as close to IC as possible.
2. Transitional voltage drops or voltage rising phenomenon could make the IC unstable if ratings are exceeded.
3. The IXD3235/36/37 series are designed to work with ceramic output capacitors. However, if the difference between input and output voltages is too high, a ceramic capacitor may fail to absorb the resulting high switching energy and oscillation could occur. In this case, connect an electrolytic capacitor in parallel to ceramic one to compensate for insufficient capacitance.
4. In PWM mode, IC generates very narrow pulses, and there is a possibility that some cycles will be skipped completely, if the difference between  $V_{IN}$  and  $V_{OUT}$  is high.
5. If the difference between  $V_{IN}$  and  $V_{OUT}$  is small, IC generates very wide pulses, and there is a possibility that some cycles will be skipped completely at the heavy load current.
6. When dropout voltage or load current is high, Current Limit may activate prematurely that will lead to IC instability. To avoid this condition, choose inductor's value to set peak current below Current Limit threshold. Calculate the peak current according to the following formula:

$$I_{PK} = (V_{IN} - V_{OUT}) \times D / (2 \times L \times f_{OSC}) + I_{OUT}, \text{ where}$$

L - Inductance

$f_{OSC}$  -- Oscillation Frequency

D – Duty cycle

7. Inductor's rated current should exceed Current Limit threshold to avoid damage, which may occur until

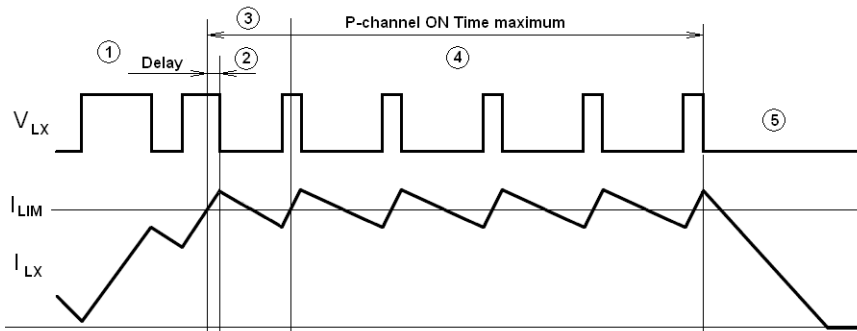

P-channel transistor turns off after Current Limiter activates (see figure below).

- ① Current flows into P-channel transistor reaches the current limit ( $I_{LIM}$ ).
- ② Current is more than  $I_{LIM}$  due the circuit's delay time from the current limit detection to the P-channel transistor OFF.
- ③ The inductor's current time rate becomes quite small.
- ④ IC generates very narrow pulses for several milliseconds.
- ⑤ The circuit latches, stopping operation.

8. If  $V_{IN}$  voltage is less than 2.4 V, current limit threshold may be not reached due voltage drop caused by switching transistor's ON resistance
9. Latch time may become longer or latch may not work due electrical noise. To avoid this effect, the board should be laid out so that input capacitors are placed as close to the IC as possible.
10. Use of the IC at voltages below recommended voltage range may lead to instability.
11. At high temperature, output voltage may increase up to input voltage level at no load, because of the leakage current of the driver transistor.
12. High step-down ratio and very light load may be cause of intermittent oscillations.
13. In PWM/PFM automatic switching mode, IC may become unstable during transition to continuous mode. Please verify with actual components.

$V_{OUT} = 3.3\text{ V}$ ,  $f_{OSC} = 1.2\text{ MHz}$ ,  $V_{IN} = 3.7\text{ V}$ ,  $I_{OUT} = 100\text{ mA}$   
Ch 1 –  $V_{LX} - 5\text{ V/div}$ ; Ch 2 –  $V_{OUT} - 2.0\text{ mV/div}$

External components:  
L =  $4.7\text{ }\mu\text{H}$  (NP4018)  
CIN =  $4.7\text{ }\mu\text{F}$  (ceramic)  
CL =  $10\text{ }\mu\text{F}$  (ceramic)

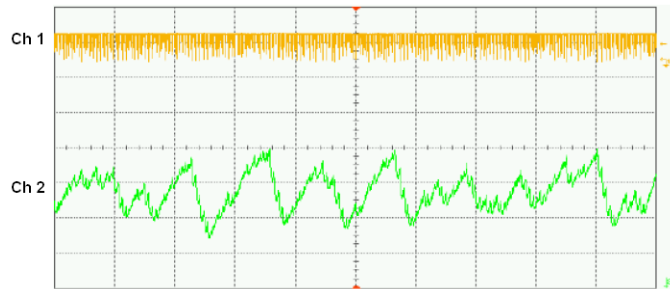

14. The IC may enter unstable operation if the combination of ambient temperature, setting voltage, oscillation frequency, and inductor's value are not adequate. If IC operates close to the maximum duty cycle, it may become unstable, even if inductor values listed below are used.

$V_{OUT} = 3.3\text{ V}$ ,  $f_{OSC} = 1.2\text{ MHz}$ ,  
 $V_{IN} = 4.0\text{ V}$ ,  $I_{OUT} = 150\text{ mA}$   
Ch 1 –  $V_{LX} - 2.0\text{ V/div}$ ;  
Ch 2 –  $V_{OUT} - 20\text{ mV/div}$

External components:  
L =  $1.5\text{ }\mu\text{H}$  (NP3015)  
CIN =  $4.7\text{ }\mu\text{F}$  (ceramic)  
CL =  $10\text{ }\mu\text{F}$  (ceramic)

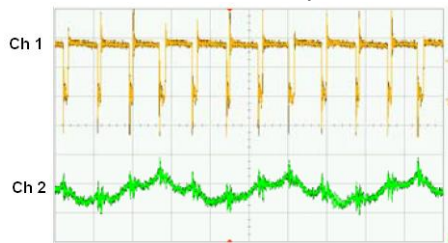

$f_{OSC}$ , MHz	$V_{OUT}$ , V	L, $\mu\text{H}$
3.0	$0.8\text{ V} < V_{OUT} < 4.0\text{ V}$	1.0 – 2.2
1.2	$V_{OUT} \leq 2.5\text{ V}$	3.3 – 6.8
	$V_{OUT} > 2.5\text{ V}$	4.7 – 6.8

If an inductor less than  $4.7\mu\text{H}$  is used at  $f_{OSC} = 1.2\text{ MHz}$ , or inductor less than  $1.5\text{ }\mu\text{H}$  is used at  $f_{OSC} = 3.0\text{ MHz}$ , inductor peak current may easily reach the current limit threshold  $I_{LIM}$ . In this case, the IC may be not able to provide  $600\text{ mA}$  output current.

15. The IC may become unstable, when it goes into continuous operation mode, and difference between  $V_{IN}$  and  $V_{OUT}$  is high.

$V_{OUT} = 1.8\text{ V}$ ,  $f_{OSC} = 1.2\text{ MHz}$ ,  
 $V_{IN} = 6.0\text{ V}$ ,  $I_{OUT} = 100\text{ mA}$   
Ch 1 –  $V_{OUT} - 10\text{ mV/div}$   
Ch 2 –  $V_{LX} - 5.0\text{ V/div}$ ;

External components:  
L =  $4.7\text{ }\mu\text{H}$  (NP4018)  
CIN =  $4.7\text{ }\mu\text{F}$  (ceramic)  
CL =  $10\text{ }\mu\text{F}$  (ceramic)

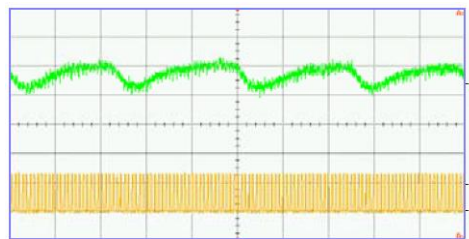

16. Note on mounting (WLP-5-03)

- Mounting pad design should be optimized for user's conditions.
- Do not use eutectics solder paste. Sn-AG-Cu solder is used for the package terminals. If eutectic solder is used, mounting reliability decreases.
- When under fill agent is used to increase interfacial bonding strength, please take enough evaluation for selection. Some under fill materials and application conditions may decrease bonding reliability.
- The IC has exposed surface of silicon material in the top marking face and sides, so it is weak against mechanical damages and external short circuit conditions. Please, take care of handling to avoid cracks and breaks and keep the circuit open to avoid short-circuit from the outside.
- Semi-transparent resin is coated on the circuit face of the package. Please be noted that the usage under strong lights may affects device's performance.

**TEST CIRCUITS**

Circuit ①

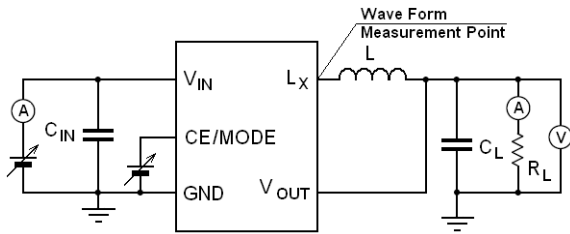

A/B/C/E/G series  
D/F series

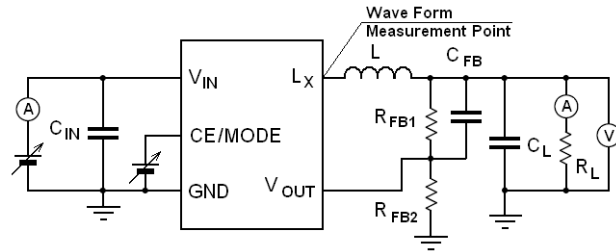

External Components  
L = 1.5  $\mu$ H (NR3015) at 3.0 MHz  
L = 4.7  $\mu$ H (NR4018) at 1.2MHz  
 $C_{IN}$  = 4.7  $\mu$ F (ceramic),  $C_L$  = 10  $\mu$ F (ceramic)

External Components  
L = 1.5  $\mu$ H (NR3015) at 3.0 MHz  
L = 4.7  $\mu$ H (NR4018) at 1.2MHz  
 $C_{IN}$  = 4.7  $\mu$ F (ceramic),  $C_L$  = 10  $\mu$ F (ceramic)

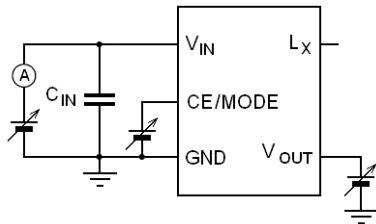

300 k $\Omega$ ,  $C_{FB}$  = 120 pF

Circuit ②

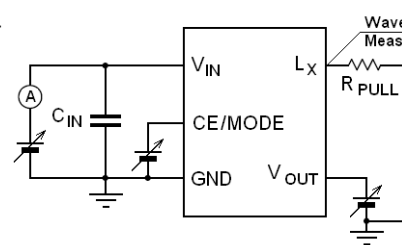

$R_{FB1}$  = 150 k $\Omega$ ,  $R_{FB2}$  =

Circuit ③

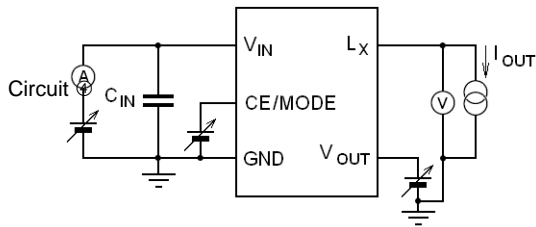

Circuit ④

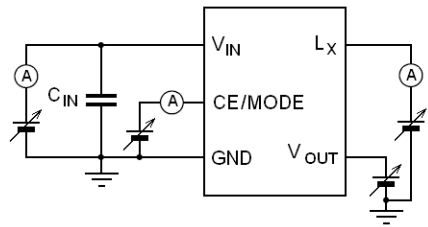

$R_{PULL}$  = 200  $\Omega$   
Circuit ⑤

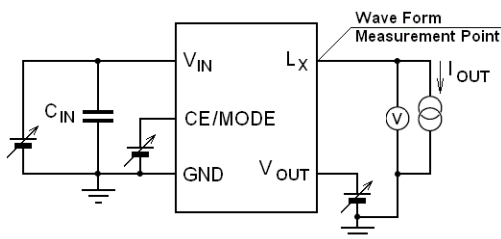

Circuit ⑥

b

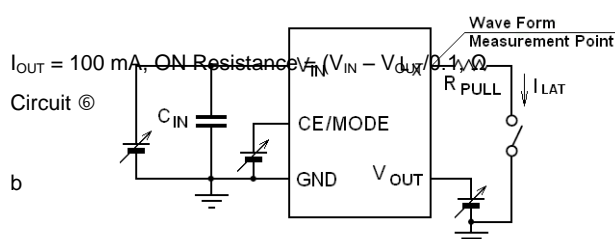

Circuit ⑦

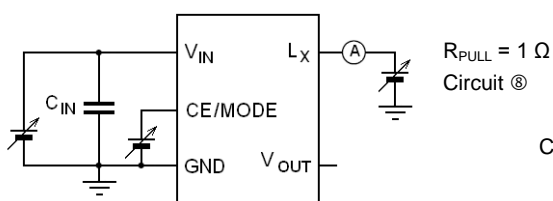

$R_{PULL}$  = 1  $\Omega$   
Circuit ⑧

Circuit ⑨

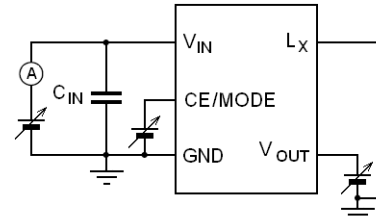



## TYPICAL PERFORMANCE CHARACTERISTICS

### (1) Efficiency vs. Output Current

Topr = 25 °C

IXD3237A18C

L = 4.7 μH (NR4018), C<sub>IN</sub> = 4.7 μF, C<sub>L</sub> = 10 μF

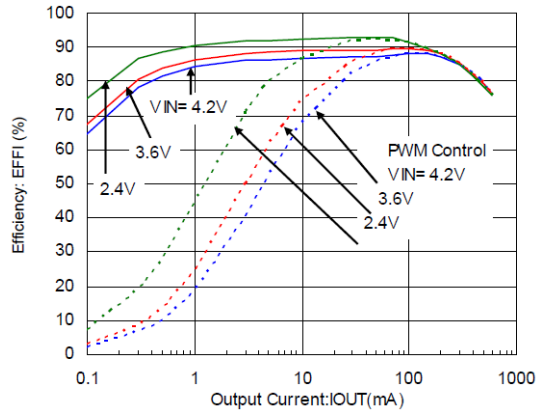

IXD3237A18D

L = 1.5 μH (NR3015), C<sub>IN</sub> = 4.7 μF, C<sub>L</sub> = 10 μF

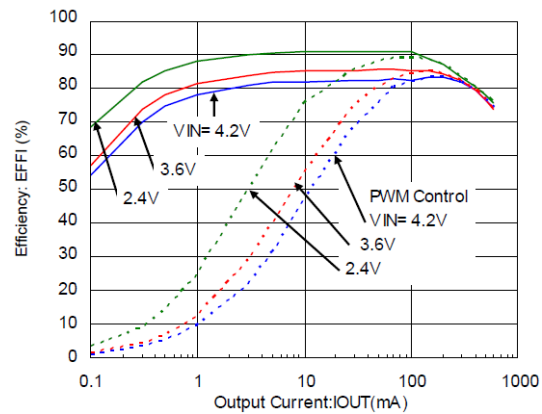

### (2) Output Voltage vs. Output Current

IXD3237A18C

L = 4.7 μH (NR4018), C<sub>IN</sub> = 4.7 μF, C<sub>L</sub> = 10 μF

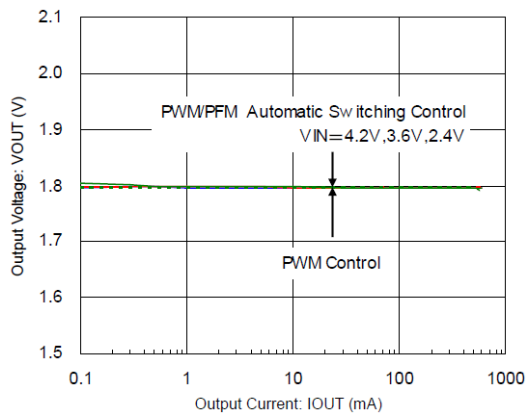

IXD3237A18D

L = 1.5 μH (NR3015), C<sub>IN</sub> = 4.7 μF, C<sub>L</sub> = 10 μF

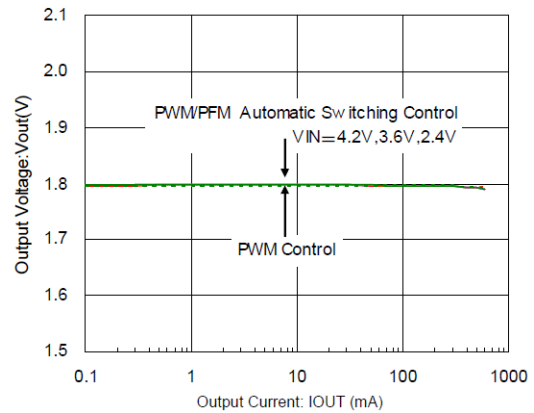

### (3) Ripple Voltage vs. Output Current

IXD3237A18C

L = 4.7 μH (NR4018), C<sub>IN</sub> = 4.7 μF, C<sub>L</sub> = 10 μF

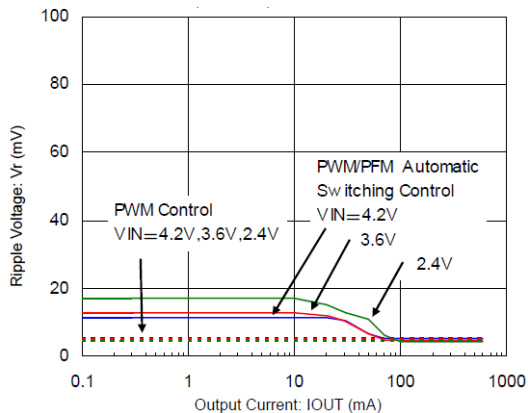

IXD3237A18D

L = 1.5 μH (NR3015), C<sub>IN</sub> = 4.7 μF, C<sub>L</sub> = 10 μF

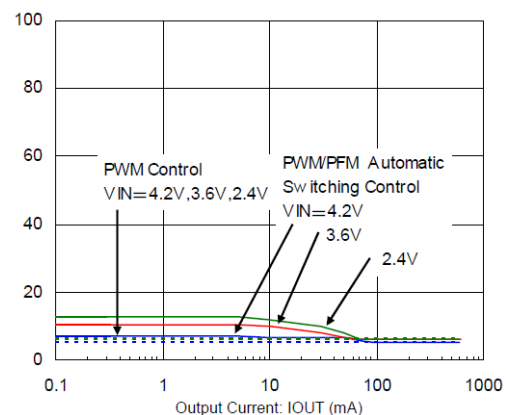

**TYPICAL PERFORMANCE CHARACTERISTICS (Continued)**

**(4) Oscillation Frequency vs. Ambient Temperature**

IXD3237A18C

L = 4.7  $\mu$ H (NR4018), C<sub>IN</sub> = 4.7  $\mu$ F, C<sub>L</sub> = 10  $\mu$ F

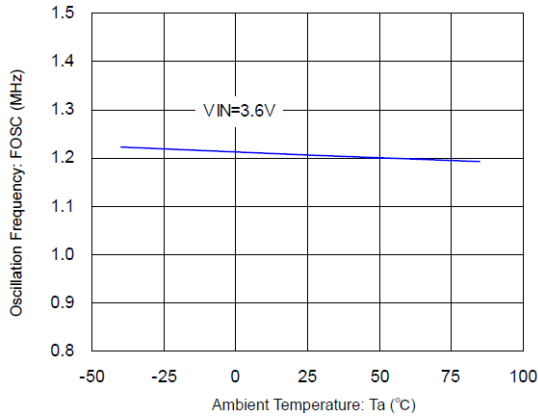

IXD3237A18D

L = 1.5  $\mu$ H (NR3015), C<sub>IN</sub> = 4.7  $\mu$ F, C<sub>L</sub> = 10  $\mu$ F

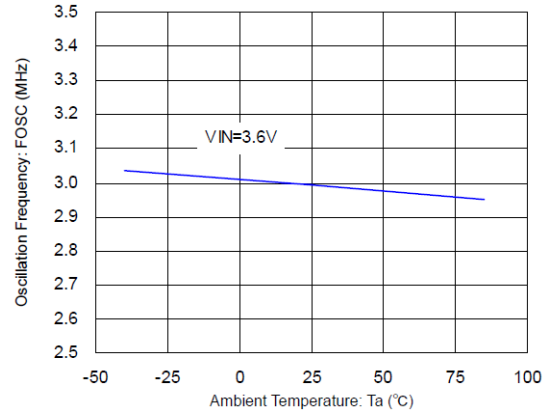

**(5) Supply Current vs. Ambient Temperature**

IXD3237A18C

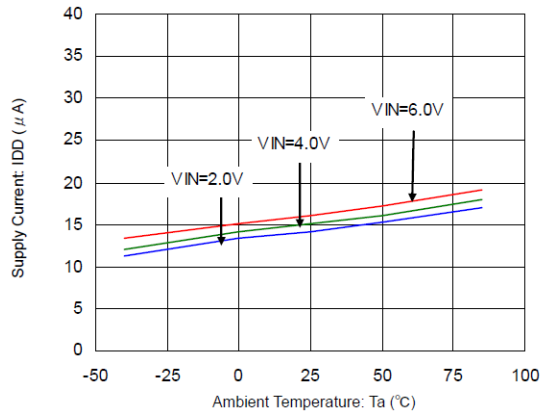

IXD3237A18D

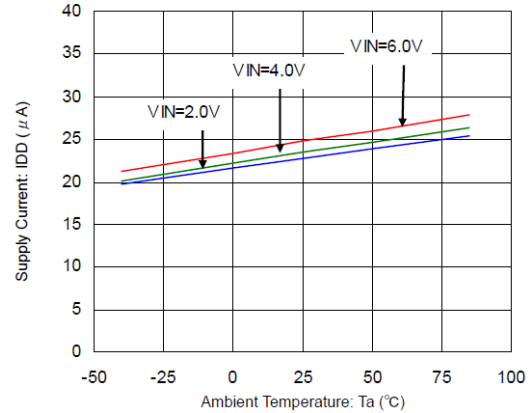

**(6) Output Voltage vs. Ambient Temperature**

IXD3237A18D

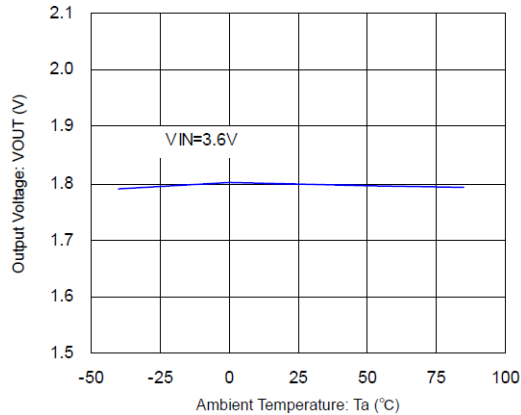

**(7) UVLO Voltage vs. Ambient Temperature**

IXD3237A18D

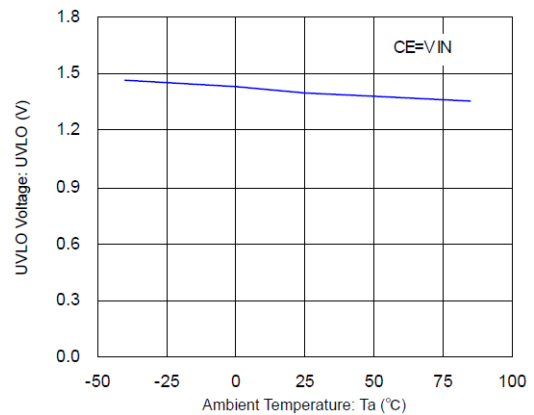

**TYPICAL PERFORMANCE CHARACTERISTICS (Continued)**

(8) CE "H" Voltage vs. Ambient Temperature

IXD3237A18D

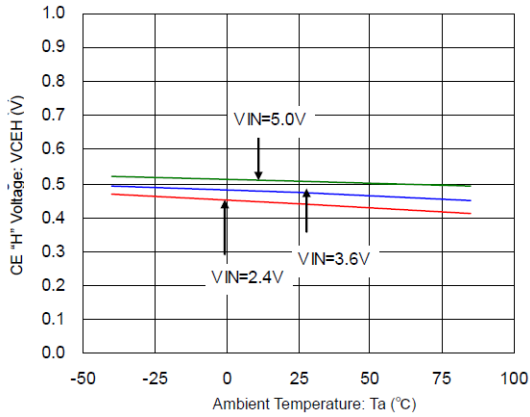

(9) CE "L" Voltage vs. Ambient Temperature

IXD3237A18D

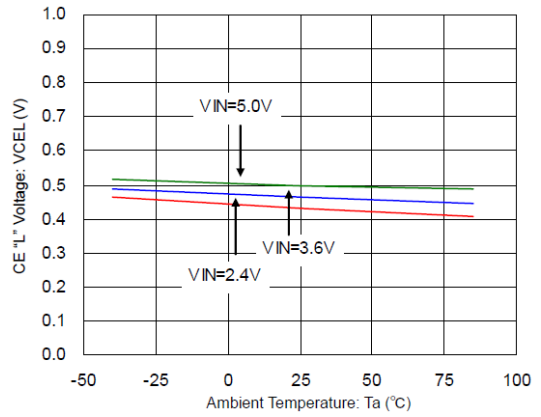

(10) Soft Start Time vs. Ambient Temperature

IXD3237A18C

L = 4.7 μH (NR4018), C<sub>IN</sub> = 4.7 μF, C<sub>L</sub> = 10 μF

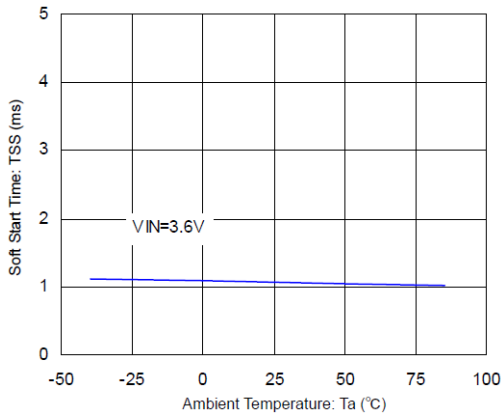

IXD3237A18D

L = 1.5 μH (NR3015), C<sub>IN</sub> = 4.7 μF, C<sub>L</sub> = 10 μF

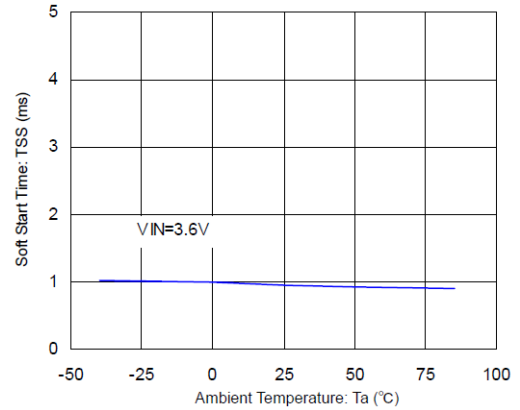

(11) ON Resistance vs. Ambient Temperature

IXD3237A18D

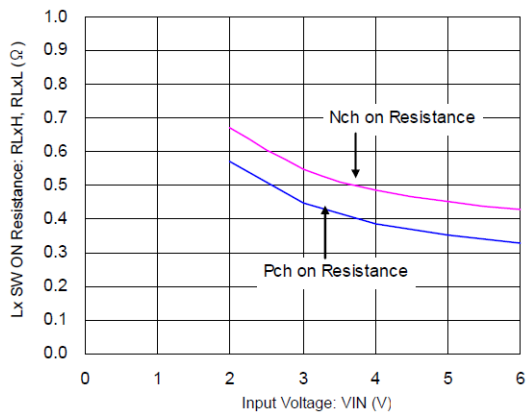

(12) IXD3235/36/37 B version Start Wave Form

IXD3237B12C

L = 4.7  $\mu$ H (NR4018), C<sub>IN</sub> = 4.7  $\mu$ F, C<sub>L</sub> = 10  $\mu$ F

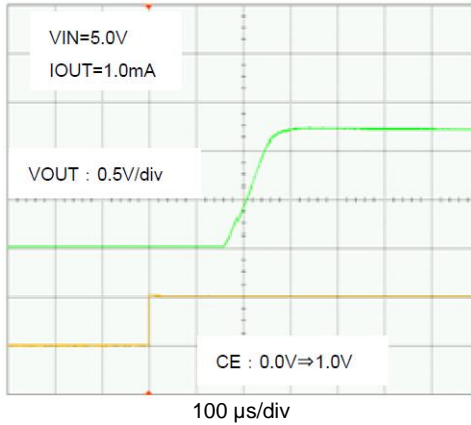

IXD3237B33D

L = 1.5  $\mu$ H (NR3015), C<sub>IN</sub> = 4.7  $\mu$ F, C<sub>L</sub> = 10  $\mu$ F

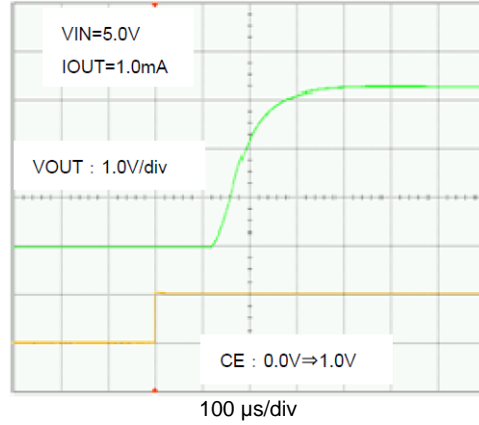

(13) IXD3235/36/37 B version Soft Start Time vs. Ambient Temperature

IXD3237B12C

L = 4.7  $\mu$ H (NR4018), C<sub>IN</sub> = 4.7  $\mu$ F, C<sub>L</sub> = 10  $\mu$ F

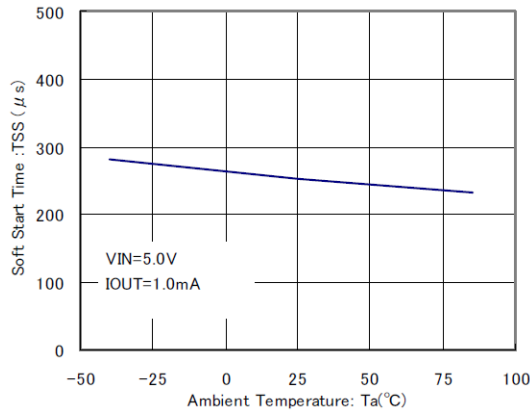

IXD3237B33D

L = 1.5  $\mu$ H (NR3015), C<sub>IN</sub> = 4.7  $\mu$ F, C<sub>L</sub> = 10  $\mu$ F

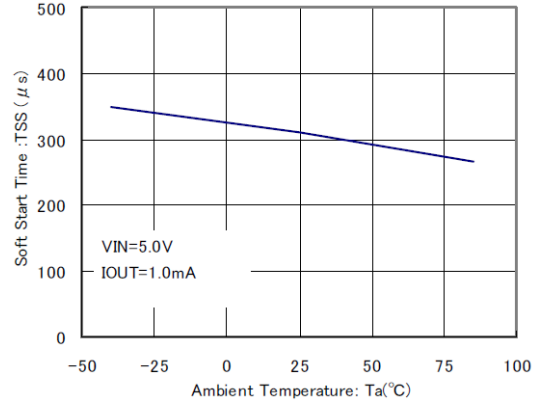

(14) IXD3235/36/37 B version C<sub>L</sub> Discharge Time vs. Ambient Temperature

IXD3237B33D

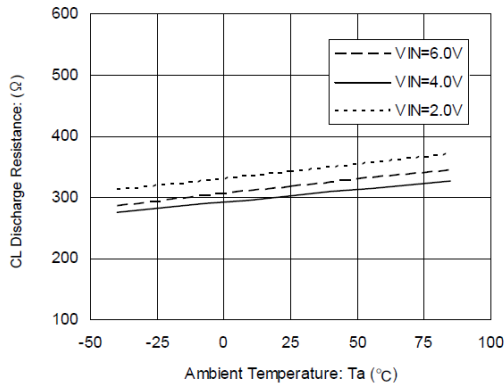

## TYPICAL PERFORMANCE CHARACTERISTICS (Continued)

### (15) Load Transient Response

IXD3237A18C

$L = 4.7 \mu\text{H}$  (NR4018),  $C_{\text{IN}} = 4.7 \mu\text{F}$ ,  $C_{\text{L}} = 10 \mu\text{F}$ ,  $V_{\text{IN}} = V_{\text{CE}} = 3.6 \text{ V}$ , (PWM/PFM Auto Switching mode)  
 $I_{\text{OUT}} = 1 \text{ mA} \rightarrow 100 \text{ mA}$

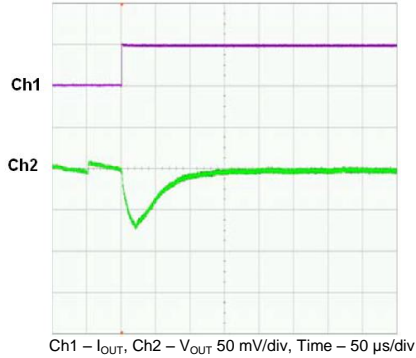

$I_{\text{OUT}} = 100 \text{ mA} \rightarrow 1 \text{ mA}$

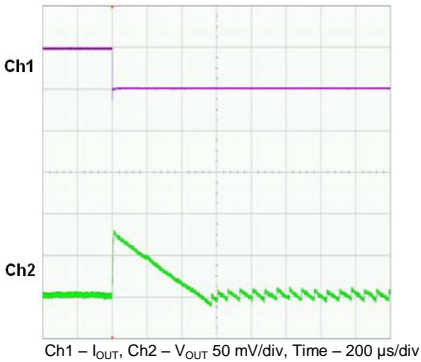

$I_{\text{OUT}} = 1 \text{ mA} \rightarrow 300 \text{ mA}$

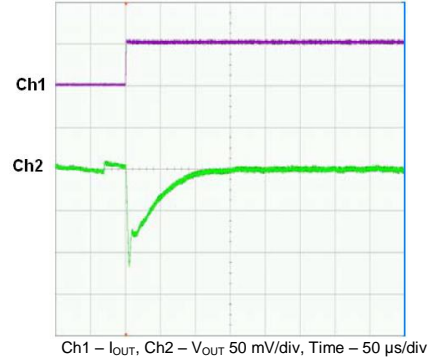

$I_{\text{OUT}} = 300 \text{ mA} \rightarrow 1 \text{ mA}$

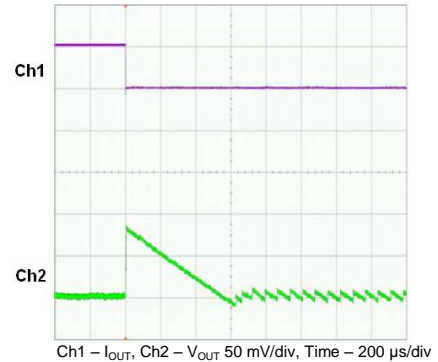

IXD3237A18C

$L = 4.7 \mu\text{H}$  (NR4018),  $C_{\text{IN}} = 4.7 \mu\text{F}$ ,  $C_{\text{L}} = 10 \mu\text{F}$ ,  $V_{\text{IN}} = 3.6 \text{ V}$ ,  $V_{\text{CE}} = 1.8 \text{ V}$  (PWM mode)  
 $I_{\text{OUT}} = 1 \text{ mA} \rightarrow 100 \text{ mA}$

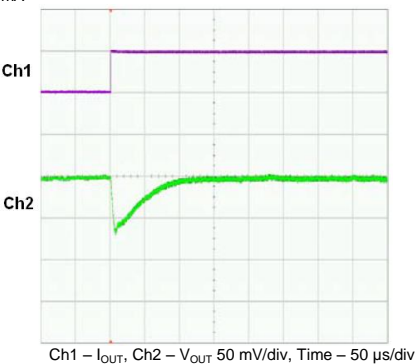

$I_{\text{OUT}} = 100 \text{ mA} \rightarrow 1 \text{ mA}$

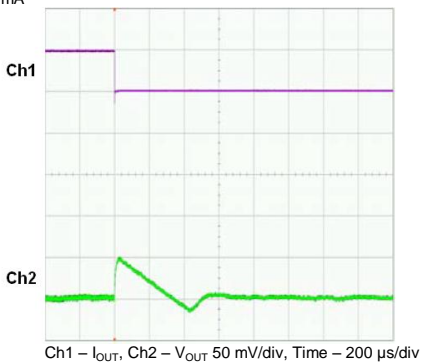

$I_{\text{OUT}} = 1 \text{ mA} \rightarrow 300 \text{ mA}$

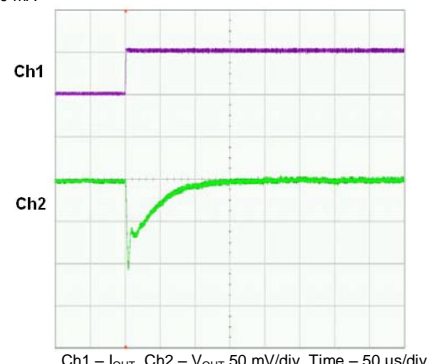

$I_{\text{OUT}} = 300 \text{ mA} \rightarrow 1 \text{ mA}$

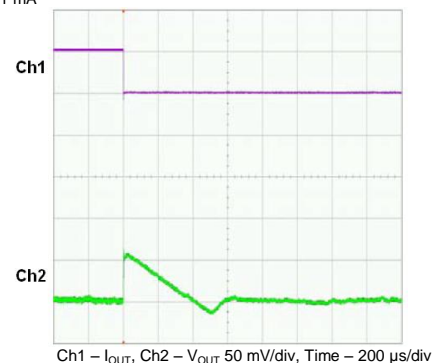

**TYPICAL PERFORMANCE CHARACTERISTICS (Continued)**

**(15) Load Transient Response (Continued)**

IXD3237A18D

$L = 1.5 \mu\text{H}$  (NR3015),  $C_{IN} = 4.7 \mu\text{F}$ ,  $C_L = 10 \mu\text{F}$ ,  $V_{IN} = V_{CE} = 3.6 \text{ V}$ , (PWM/PFM Auto Switching mode)

$I_{OUT} = 1 \text{ mA} \rightarrow 100 \text{ mA}$

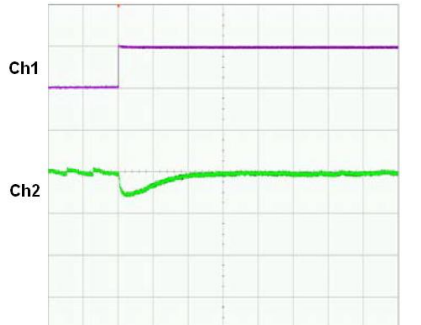

Ch1 –  $I_{OUT}$ , Ch2 –  $V_{OUT}$  50 mV/div, Time – 50  $\mu\text{s}$ /div

$I_{OUT} = 100 \text{ mA} \rightarrow 1 \text{ mA}$

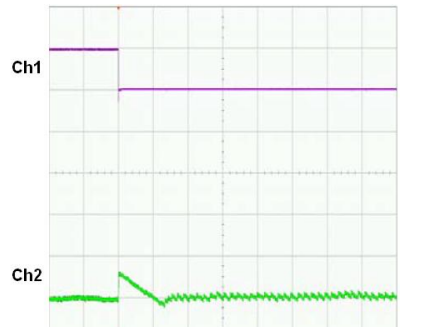

Ch1 –  $I_{OUT}$ , Ch2 –  $V_{OUT}$  50 mV/div, Time – 200  $\mu\text{s}$ /div

IXD3237A18D

$L = 1.5 \mu\text{H}$  (NR3015),  $C_{IN} = 4.7 \mu\text{F}$ ,  $C_L = 10 \mu\text{F}$ ,  $V_{IN} = 3.6 \text{ V}$ ,  $V_{CE} = 1.8 \text{ V}$  (PWM mode)

$I_{OUT} = 1 \text{ mA} \rightarrow 100 \text{ mA}$

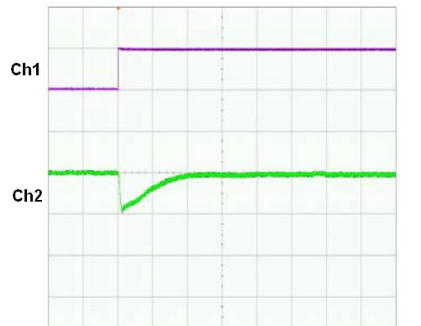

Ch1 –  $I_{OUT}$ , Ch2 –  $V_{OUT}$  50 mV/div, Time – 50  $\mu\text{s}$ /div

$I_{OUT} = 100 \text{ mA} \rightarrow 1 \text{ mA}$

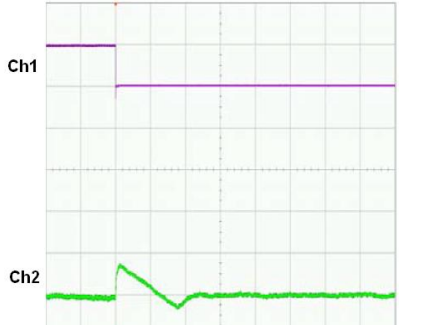

Ch1 –  $I_{OUT}$ , Ch2 –  $V_{OUT}$  50 mV/div, Time – 200  $\mu\text{s}$ /div

$I_{OUT} = 1 \text{ mA} \rightarrow 300 \text{ mA}$

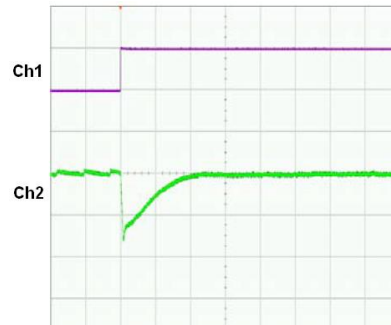

Ch1 –  $I_{OUT}$ , Ch2 –  $V_{OUT}$  50 mV/div, Time – 50  $\mu\text{s}$ /div

$I_{OUT} = 300 \text{ mA} \rightarrow 1 \text{ mA}$

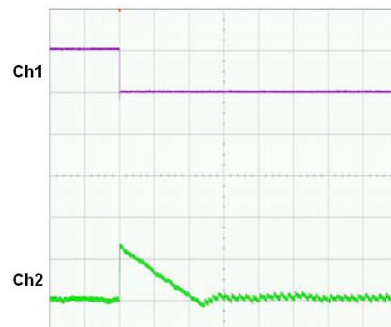

Ch1 –  $I_{OUT}$ , Ch2 –  $V_{OUT}$  50 mV/div, Time – 200  $\mu\text{s}$ /div

$I_{OUT} = 1 \text{ mA} \rightarrow 300 \text{ mA}$

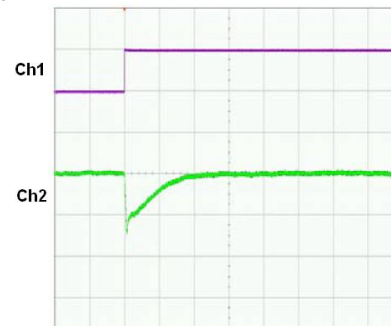

Ch1 –  $I_{OUT}$ , Ch2 –  $V_{OUT}$  50 mV/div, Time – 50  $\mu\text{s}$ /div

$I_{OUT} = 300 \text{ mA} \rightarrow 1 \text{ mA}$

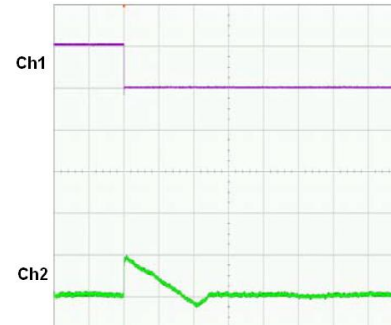

Ch1 –  $I_{OUT}$ , Ch2 –  $V_{OUT}$  50 mV/div, Time – 200  $\mu\text{s}$ /div

## ORDERING INFORMATION

IXD3235①②③④⑤⑥-⑦

IXD3236①②③④⑤⑥-⑦

IXD3237①②③④⑤⑥-⑦

DESIGNATOR	DESCRIPTION	SYMBOL	DESCRIPTION
①	Type of DC/DC Controller	A	Refer to Product Classification
		B	
		C	
		E	
		G	
		D	
②③	Fixed Output Voltage, V	08 - 40	② - integer part, ③ - decimal part, i.e. $V_{OUT} = 2.8\text{ V} - \textcircled{2} = 2, \textcircled{3} = 8$ $V_{OUT} = 2.85\text{ V} - \textcircled{2} = 2, \textcircled{3} = L$ 0.05 V increments: 0.05 = A, 0.15 = B, 0.25 = C, 0.35 = D, 0.45 = E, 0.55 = F, 0.65 = H, 0.75 = K, 0.85 = L, 0.95 = M
	Reference Voltage	08	Reference Voltage (Fixed) $0.8\text{ V} - \textcircled{2} = 0, \textcircled{3} = 8$
④	Oscillation Frequency	C	1.2 MHz
		D	3.0 MHz
⑤⑥-⑦*	Packages (Order Limit)	MR	SOT-25 (3000/reel)
		MR-G	SOT-25 (3000/reel)
		ER	USP-6C (3000/reel)
		ER-G	USP-6C (3000/reel)
		4R-G	USP-6EL (3000/reel)
		0R-G	WLP-5-03 (3000/reel)

NOTE:

- 1) The "-G" suffix denotes halogen and antimony free, as well as being fully RoHS compliant.
- 2) SOT-25, USP-6EL package are available for the A/B/C series only.
- 3) WLP-5-03 package is available for the A/B series only.

## PRODUCT CLASSIFICATION

Type	VOUT		VIN		C <sub>L</sub> Auto discharge	Soft Start	
	Fixed	Adjustable	≥ 1.8 V	≥ 2 V		High Speed	Low Speed
A	Yes	No	No	Yes	No	No	Yes
B	Yes	No	No	Yes	Yes	Yes	No
C	Yes	No	No	Yes	Yes	No	Yes
D	No	Yes	Yes	No	Yes	No	Yes
E	Yes	No	Yes	No	Yes	No	Yes
F	No	Yes	Yes	No	Yes	Yes	No
G	Yes	No	Yes	No	Yes	Yes	No

**PACKAGE DRAWING AND DIMENSIONS**

(Units: mm)

**SOT-25**

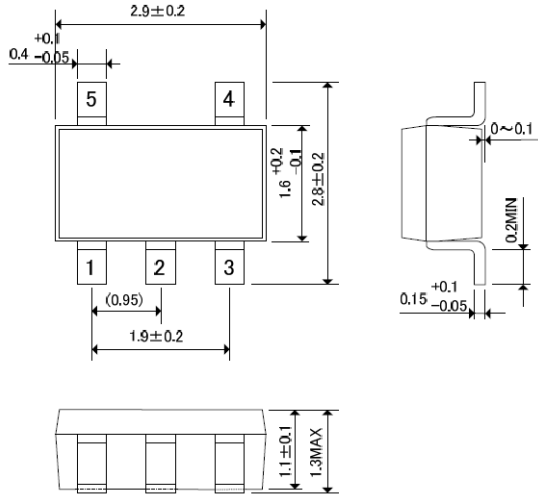

**USP-6C**

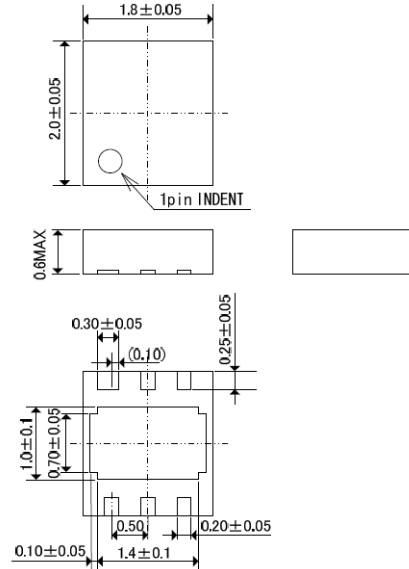

**USP-6C Reference Pattern Layout**

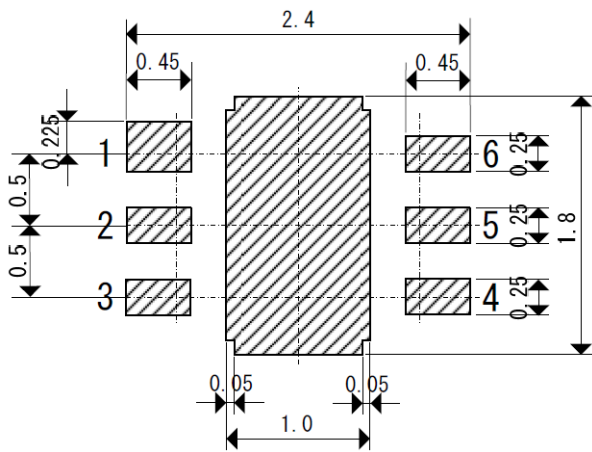

**USP-6C Reference Metal Mask Design**

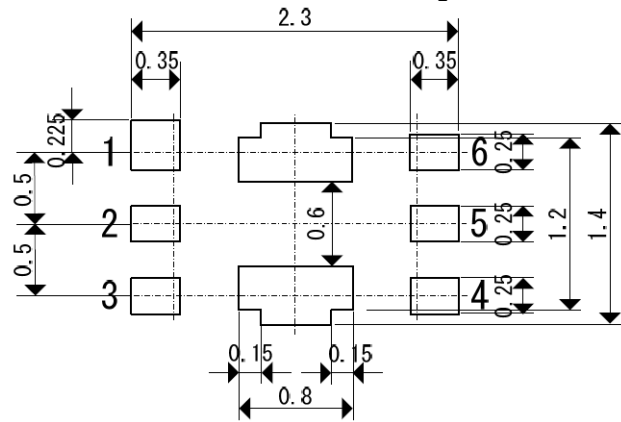





## MARKING

### SOT-25

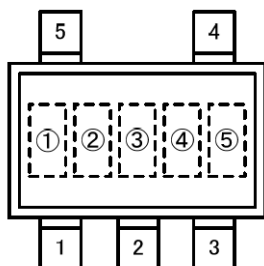

(TOP VIEW)

① Represents product series

PRODUCT SERIES	MARK		
	IXD3235	IXD3236	IXD3237
A	4	5	6
B	C	D	E
C	K	L	M
D	K	L	M
E	4	5	6
F	2	7	B
G	C	D	E

USP-6C/USP-6EL  
oscillation frequency

② Represents integer number of the output voltage and

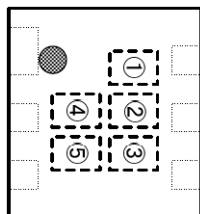

(TOP VIEW)

A/B/C/F series

V <sub>OUT</sub> , V	MARK	
	f <sub>OSC</sub> = 1.2 MHz	f <sub>OSC</sub> = 3.0 MHz
0.x	A	F
1.x	B	H
2.x	C	K
3.x	D	L
4.x	E	M

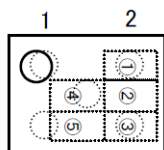

(TOP VIEW)

WLP-5-03

E/G/D Series

V <sub>OUT</sub> , V	MARK	
	f <sub>OSC</sub> = 1.2 MHz	f <sub>OSC</sub> = 3.0 MHz
0.x	A	F
1.x	B	H
2.x	C	K
3.x	D	L
4.x	E	M

③ Represents decimal value of the output voltage

V <sub>OUT</sub> , V	MARK	V <sub>OUT</sub> , V	MARK
x.00	0	x.05	A
x.10	1	x.15	B
x.20	2	x.25	C
x.30	3	x.35	D
x.40	4	x.45	E
x.50	5	x.55	F
x.60	6	x.65	H
x.70	7	x.75	K
x.80	8	x.85	L
x.90	9	X.95	M

④⑤ represents production lot number

01~09, 0A~0Z, 11~9Z, A1~A9, AA~AZ, B1~ZZ in order  
(G, I, J, O, Q, and W excluded)

## Customer Support

To share comments, get your technical questions answered, or report issues you may be experiencing with our products, please visit Zilog's Technical Support page at <http://support.zilog.com>. To learn more about this product, find additional documentation, or to discover other facets about Zilog product offerings, please visit the Zilog Knowledge Base at <http://zilog.com/kb> or consider participating in the Zilog Forum at <http://zilog.com/forum>. This publication is subject to replacement by a later edition. To determine whether a later edition exists, please visit the Zilog website at <http://www.zilog.com>.

---

**Warning:** DO NOT USE THIS PRODUCT IN LIFE SUPPORT SYSTEMS.

---

**LIFE SUPPORT POLICY** ZILOG'S PRODUCTS ARE NOT AUTHORIZED FOR USE AS CRITICAL COMPONENTS IN LIFE SUPPORT DEVICES OR SYSTEMS WITHOUT THE EXPRESS PRIOR WRITTEN APPROVAL OF THE PRESIDENT AND GENERAL COUNSEL OF ZILOG CORPORATION.

**As used herein** Life support devices or systems are devices which (a) are intended for surgical implant into the body, or (b) support or sustain life and whose failure to perform when properly used in accordance with instructions for use provided in the labeling can be reasonably expected to result in a significant injury to the user. A critical component is any component in a life support device or system whose failure to perform can be reasonably expected to cause the failure of the life support device or system or to affect its safety or effectiveness.

**Document Disclaimer** ©2015 Zilog, Inc. All rights reserved. Information in this publication concerning the devices, applications, or technology described is intended to suggest possible uses and may be superseded. ZILOG, INC. DOES NOT ASSUME LIABILITY FOR OR PROVIDE A REPRESENTATION OF ACCURACY OF THE INFORMATION, DEVICES, OR TECHNOLOGY DESCRIBED IN THIS DOCUMENT. ZILOG ALSO DOES NOT ASSUME LIABILITY FOR INTELLECTUAL PROPERTY INFRINGEMENT RELATED IN ANY MANNER TO USE OF INFORMATION, DEVICES, OR TECHNOLOGY DESCRIBED HEREIN OR OTHERWISE. The information contained within this document has been verified according to the general principles of electrical and mechanical engineering.