

EProClock[®] Programmable PCIe Gen 2 Clock Generator

Features

- Compliant to PCI-Express Gen 1 and Gen 2
- Low power push-pull type differential output buffers
- Integrated resistors on differential clocks
- Wireless friendly 3-bits slew rate control on single-ended clocks.
- 100MHz Differential SRC clocks
- Two Programmable Single Ended clocks
- Buffered Reference Clock 25MHz
- 25MHz Crystal Input or Clock input
- EProClock[®] Programmable Technology
- I²C support with readback capabilities
- Triangular Spread Spectrum profile for maximum electromagnetic interference (EMI) reduction
- Industrial Temperature -40°C to 85°C
- 3.3V Power supply
- 32-pin QFN package

SRC	25M	Prog_SE
x6	x1	x2

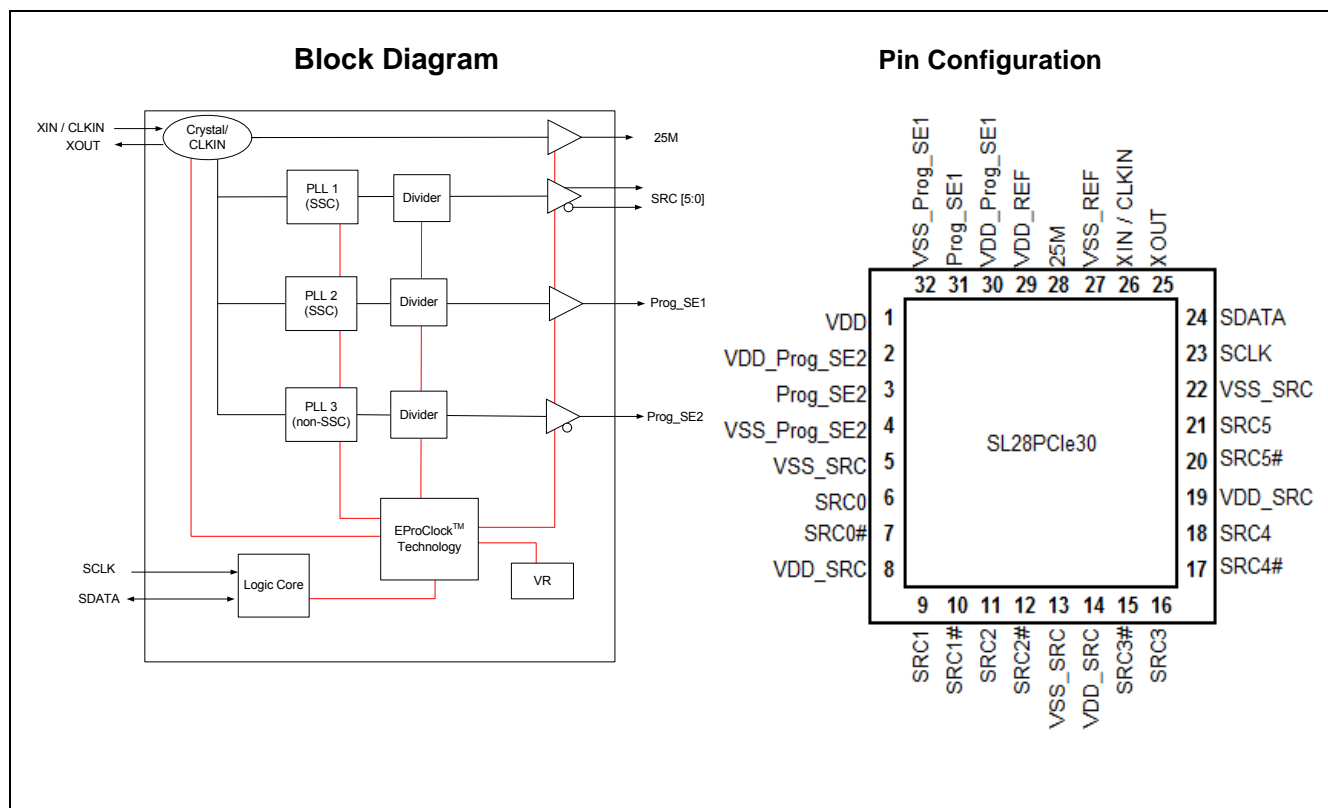

32-QFN Pin Definitions

Pin No.	Name	Type	Description
1	VDD	PWR	3.3V Power Supply
2	VDD_Prog_SE2	PWR	3.3V Power Supply for Prog_SE2 clock
3	Prog_SE2	O, SE	Programmable Single ended output with OTP programmable (EProClock™) custom frequency
4	VSS_Prog_SE2	GND	Ground for Prog_SE2 clock
5	VSS_SRC	GND	Ground for SRC clocks
6	SRC0	O, DIF	100MHz True differential serial reference clock
7	SRC0#	O, DIF	100MHz Complementary differential serial reference clock
8	VDD_SRC	PWR	3.3V Power Supply for SRC clocks
9	SRC1	O, DIF	100MHz True differential serial reference clock
10	SRC1#	O, DIF	100MHz Complementary differential serial reference clock
11	SRC2	O, DIF	100MHz True differential serial reference clock
12	SRC2#	O, DIF	100MHz Complementary differential serial reference clock
13	VSS_SRC	GND	Ground for SRC clocks
14	VDD_SRC	PWR	3.3V Power Supply for SRC clocks
15	SRC3#	O, DIF	100MHz Complementary differential serial reference clock
16	SRC3	O, DIF	100MHz True differential serial reference clock
17	SRC4#	O, DIF	100MHz Complementary differential serial reference clock
18	SRC4	O, DIF	100MHz True differential serial reference clock
19	VDD_SRC	PWR	3.3V Power Supply for SRC clocks
20	SRC5#	O, DIF	100MHz Complementary differential serial reference clock
21	SRC5	O, DIF	100MHz True differential serial reference clock
22	VSS_SRC	GND	Ground for SRC clocks
23	SCLK	I	SMBus compatible SCLOCK
24	SDATA	I/O	SMBus compatible SDATA
25	XOUT	O	25.00MHz clock output. Float XOUT if using only CLKIN (Clock input)
26	XIN/ CLKIN	I	25.00MHz Crystal input or 3.3V, 25MHz Clock input
27	VSS_REF	GND	Ground for 25M clock
28	25M	O	25MHz reference output clock
29	VDD_REF	PWR	3.3V Power Supply for 25M clock
30	VDD_Prog_SE1	PWR	3.3V Power Supply for Prog_SE1 clock
31	Prog_SE1	O, SE	Programmable Single ended output with OTP programmable (EProClock™) custom frequency
32	VSS_Prog_SE1	GND	Ground for Prog_SE1 clock

EProClock® Programmable Technology

EProClock® is the world's first non-volatile programmable clock. The EProClock® technology allows board designer to promptly achieve optimum compliance and clock signal integrity; historically, attainable typically through device and/or board redesigns.

EProClock® technology can be configured through SMBus or hard coded.

Features:

- > 4000 bits of configurations

- Can be configured through SMBus or hard coded
- Custom frequency sets
- Differential skew control on true or compliment or both
- Differential duty cycle control on true or compliment or both
- Differential amplitude control
- Differential and single-ended slew rate control
- Program Internal or External series resistor on single-ended clocks

- Program different spread profiles
- Program different spread modulation rate

Serial Data Interface

To enhance the flexibility and function of the clock synthesizer, a two-signal serial interface is provided. Through the Serial Data Interface, various device functions, such as individual clock output buffers are individually enabled or disabled. The registers associated with the Serial Data Interface initialize to their default setting at power-up. The use of this interface is optional. Clock device register changes are normally made at system initialization, if any are required. The interface cannot be used during system operation for power management functions.

Data Protocol

The clock driver serial protocol accepts byte write, byte read, block write, and block read operations from the controller. For block write/read operation, access the bytes in sequential order from lowest to highest (most significant bit first) with the ability to stop after any complete byte is transferred. For byte write and byte read operations, the system controller can access individually indexed bytes. The offset of the indexed byte is encoded in the command code described in *Table 1*.

The block write and block read protocol is outlined in *Table 2* while *Table 3* outlines byte write and byte read protocol. The slave receiver address is 11010010 (D2h).

Table 1. Command Code Definition

Bit	Description
7	0 = Block read or block write operation, 1 = Byte read or byte write operation
(6:0)	Byte offset for byte read or byte write operation. For block read or block write operations, these bits should be '0000000'

Table 2. Block Read and Block Write Protocol

Block Write Protocol		Block Read Protocol	
Bit	Description	Bit	Description
1	Start	1	Start
8:2	Slave address–7 bits	8:2	Slave address–7 bits
9	Write	9	Write
10	Acknowledge from slave	10	Acknowledge from slave
18:11	Command Code–8 bits	18:11	Command Code–8 bits
19	Acknowledge from slave	19	Acknowledge from slave
27:20	Byte Count–8 bits	20	Repeat start
28	Acknowledge from slave	27:21	Slave address–7 bits
36:29	Data byte 1–8 bits	28	Read = 1
37	Acknowledge from slave	29	Acknowledge from slave
45:38	Data byte 2–8 bits	37:30	Byte Count from slave–8 bits
46	Acknowledge from slave	38	Acknowledge
....	Data Byte /Slave Acknowledges	46:39	Data byte 1 from slave–8 bits
....	Data Byte N–8 bits	47	Acknowledge
....	Acknowledge from slave	55:48	Data byte 2 from slave–8 bits
....	Stop	56	Acknowledge
		Data bytes from slave / Acknowledge
		Data Byte N from slave–8 bits
		NOT Acknowledge
		Stop

Table 3. Byte Read and Byte Write Protocol

Byte Write Protocol		Byte Read Protocol	
Bit	Description	Bit	Description
1	Start	1	Start

Table 3. Byte Read and Byte Write Protocol

8:2	Slave address–7 bits	8:2	Slave address–7 bits
9	Write	9	Write
10	Acknowledge from slave	10	Acknowledge from slave
18:11	Command Code–8 bits	18:11	Command Code–8 bits
19	Acknowledge from slave	19	Acknowledge from slave
27:20	Data byte–8 bits	20	Repeated start
28	Acknowledge from slave	27:21	Slave address–7 bits
29	Stop	28	Read
		29	Acknowledge from slave
		37:30	Data from slave–8 bits
		38	NOT Acknowledge
		39	Stop

Control Registers

Byte 0: Control Register 0

Bit	@Pup	Name	Description
7	0	RESERVED	RESERVED
6	0	RESERVED	RESERVED
5	0	Spread Enable	Enable spread for SRC[1:5] outputs 0=Disable, 1= -0.5%
4	0	RESERVED	RESERVED
3	0	RESERVED	RESERVED
2	0	RESERVED	RESERVED
1	0	RESERVED	RESERVED
0	0	RESERVED	RESERVED

Byte 1: Control Register 1

Bit	@Pup	Name	Description
7	0	RESERVED	RESERVED
6	1	SRC0_OE	Output enable for SRC0 0 = Output Disabled, 1 = Output Enabled
5	0	RESERVED	RESERVED
4	0	RESERVED	RESERVED
3	1	SRC1_OE	Output enable for SRC1 0 = Output Disabled, 1 = Output Enabled
2	1	RESERVED	RESERVED
1	0	RESERVED	RESERVED
0	0	RESERVED	RESERVED

Byte 2: Control Register 2

Bit	@Pup	Name	Description
7	1	Prog_SE2_OE	Output enable for Prog_SE2 0 = Output Disabled, 1 = Output Enabled
6	0	RESERVED	RESERVED

Byte 2: Control Register 2 (continued)

Bit	@Pup	Name	Description
5	1	Prog_SE1_OE	Output enable for Prog_SE1 0 = Output Disabled, 1 = Output Enabled
4	1	25M_OE	Output enable for 25M 0 = Output Disabled, 1 = Output Enabled
3	0	RESERVED	RESERVED
2	0	RESERVED	RESERVED
1	0	RESERVED	RESERVED
0	0	RESERVED	RESERVED

Byte 3: Control Register 3

Bit	@Pup	Name	Description
7	1	SRC4_OE	Output enable for SRC4 0 = Output Disabled, 1 = Output Enabled
6	1	SRC5_OE	Output enable for SRC5 0 = Output Disabled, 1 = Output Enabled
5	0	RESERVED	RESERVED
4	0	RESERVED	RESERVED
3	0	RESERVED	RESERVED
2	0	RESERVED	RESERVED
1	0	RESERVED	RESERVED
0	0	RESERVED	RESERVED

Byte 4: Control Register 4

Bit	@Pup	Name	Description
7	0	RESERVED	RESERVED
6	0	RESERVED	RESERVED
5	0	RESERVED	RESERVED
4	0	RESERVED	RESERVED
3	0	RESERVED	RESERVED
2	0	RESERVED	RESERVED
1	0	RESERVED	RESERVED
0	0	RESERVED	RESERVED

Byte 5: Control Register 5

Bit	@Pup	Name	Description
7	0	RESERVED	RESERVED
6	0	RESERVED	RESERVED
5	0	RESERVED	RESERVED
4	0	RESERVED	RESERVED
3	0	RESERVED	RESERVED
2	0	RESERVED	RESERVED
1	0	RESERVED	RESERVED
0	0	RESERVED	RESERVED

Byte 6: Control Register 6

Bit	@Pup	Name	Description
7	0	SRC[4:5]_AMP	SRC[4:5] amplitude adjustment 00= 700mV, 01=800mV, 10=900mV, 11= 1000mV
6	1	SRC[4:5]_AMP	
5	0	SRC[1:3]_AMP	SRC[1:3] amplitude adjustment 00= 700mV, 01=800mV, 10=900mV, 11= 1000mV
4	1	SRC[1:3]_AMP	
3	0	RESERVED	RESERVED
2	1	RESERVED	RESERVED
1	0	SRC0_AMP	SRC0 amplitude adjustment 00= 700mV, 01=800mV, 10=900mV, 11= 1000mV
0	1	SRC0_AMP	

Byte 7: Vendor ID

Bit	@Pup	Name	Description
7	0	Rev Code Bit 3	Revision Code Bit 3
6	0	Rev Code Bit 2	Revision Code Bit 2
5	0	Rev Code Bit 1	Revision Code Bit 1
4	1	Rev Code Bit 0	Revision Code Bit 0
3	1	Vendor ID bit 3	Vendor ID Bit 3
2	0	Vendor ID bit 2	Vendor ID Bit 2
1	0	Vendor ID bit 1	Vendor ID Bit 1
0	0	Vendor ID bit 0	Vendor ID Bit 0

Byte 8: Control Register 8

Bit	@Pup	Name	Description
7	0	BC7	Byte count register for block read operation. The default value for Byte count is 15 In order to read beyond Byte 15, the user should change the byte count limit to or beyond the byte that is desired to be read.
6	0	BC6	
5	0	BC5	
4	0	BC4	
3	1	BC3	
2	1	BC2	
1	1	BC1	
0	1	BC0	

Byte 9: Control Register 9

Bit	@Pup	Name	Description
7	0	RESERVED	RESERVED
6	1	SRC3_OE	Output enable for SRC3 0 = Output Disabled, 1 = Output Enabled
5	1	SRC2_OE	Output enable for SRC2 0 = Output Disabled, 1 = Output Enabled
4	0	RESERVED	RESERVED
3	0	RESERVED	RESERVED
2	0	RESERVED	RESERVED
1	0	RESERVED	RESERVED
0	1	RESERVED	RESERVED

Byte 10: Control Register 10

Bit	@Pup	Name	Description
7	0	RESERVED	RESERVED
6	0	RESERVED	RESERVED
5	0	RESERVED	RESERVED
4	0	RESERVED	RESERVED
3	0	RESERVED	RESERVED
2	0	RESERVED	RESERVED
1	0	RESERVED	RESERVED
0	0	RESERVED	RESERVED

Byte 11: Control Register 11

Bit	@Pup	Name	Description																																													
7	1	Prog_SE2_Bit2	Drive Strength Control - Bit[2:0] Normal mode default '101' Wireless Friendly Mode default to '111'																																													
6	0	Prog_SE2_Bit1																																														
5	1	Prog_SE2_Bit0	<table border="1"> <thead> <tr> <th>Mode</th> <th>Bit2</th> <th>Bit1</th> <th>Bit0</th> <th>Buffer Strength</th> </tr> </thead> <tbody> <tr> <td></td> <td>0</td> <td>0</td> <td>0</td> <td rowspan="6"> <div style="text-align: center;">Strong</div> <div style="text-align: center;">↓</div> </td> </tr> <tr> <td></td> <td>0</td> <td>0</td> <td>1</td> </tr> <tr> <td></td> <td>0</td> <td>1</td> <td>0</td> </tr> <tr> <td></td> <td>0</td> <td>1</td> <td>1</td> </tr> <tr> <td></td> <td>1</td> <td>0</td> <td>0</td> </tr> <tr> <td></td> <td>1</td> <td>0</td> <td>1</td> </tr> <tr> <td>Default</td> <td>1</td> <td>0</td> <td>1</td> <td></td> </tr> <tr> <td></td> <td>1</td> <td>1</td> <td>0</td> <td></td> </tr> <tr> <td>Wireless Friendly</td> <td>1</td> <td>1</td> <td>1</td> <td>Weak</td> </tr> </tbody> </table>	Mode	Bit2	Bit1	Bit0	Buffer Strength		0	0	0	<div style="text-align: center;">Strong</div> <div style="text-align: center;">↓</div>		0	0	1		0	1	0		0	1	1		1	0	0		1	0	1	Default	1	0	1			1	1	0		Wireless Friendly	1	1	1	Weak
Mode	Bit2	Bit1		Bit0	Buffer Strength																																											
	0	0		0	<div style="text-align: center;">Strong</div> <div style="text-align: center;">↓</div>																																											
	0	0		1																																												
	0	1		0																																												
	0	1		1																																												
	1	0		0																																												
	1	0		1																																												
Default	1	0	1																																													
	1	1	0																																													
Wireless Friendly	1	1	1	Weak																																												
4	1	25M_Bit2																																														
3	0	25M_Bit1																																														
2	1	25M_Bit0																																														
1	1	RESERVED																																														
0	1	RESERVED																																														

Byte 12: Byte Count

Bit	@Pup	Name	Description																																													
7	1	Prog_SE1_Bit2	Drive Strength Control - Bit[2:0] Normal mode default '101' Wireless Friendly Mode default to '111'																																													
6	0	Prog_SE1_Bit1																																														
5	1	Prog_SE1_Bit0	<table border="1"> <thead> <tr> <th>Mode</th> <th>Bit2</th> <th>Bit1</th> <th>Bit0</th> <th>Buffer Strength</th> </tr> </thead> <tbody> <tr> <td></td> <td>0</td> <td>0</td> <td>0</td> <td rowspan="6"> <div style="text-align: center;">Strong</div> <div style="text-align: center;">↓</div> </td> </tr> <tr> <td></td> <td>0</td> <td>0</td> <td>1</td> </tr> <tr> <td></td> <td>0</td> <td>1</td> <td>0</td> </tr> <tr> <td></td> <td>0</td> <td>1</td> <td>1</td> </tr> <tr> <td></td> <td>1</td> <td>0</td> <td>0</td> </tr> <tr> <td></td> <td>1</td> <td>0</td> <td>1</td> </tr> <tr> <td>Default</td> <td>1</td> <td>0</td> <td>1</td> <td></td> </tr> <tr> <td></td> <td>1</td> <td>1</td> <td>0</td> <td></td> </tr> <tr> <td>Wireless Friendly</td> <td>1</td> <td>1</td> <td>1</td> <td>Weak</td> </tr> </tbody> </table>	Mode	Bit2	Bit1	Bit0	Buffer Strength		0	0	0	<div style="text-align: center;">Strong</div> <div style="text-align: center;">↓</div>		0	0	1		0	1	0		0	1	1		1	0	0		1	0	1	Default	1	0	1			1	1	0		Wireless Friendly	1	1	1	Weak
Mode	Bit2	Bit1		Bit0	Buffer Strength																																											
	0	0		0	<div style="text-align: center;">Strong</div> <div style="text-align: center;">↓</div>																																											
	0	0		1																																												
	0	1		0																																												
	0	1		1																																												
	1	0		0																																												
	1	0		1																																												
Default	1	0	1																																													
	1	1	0																																													
Wireless Friendly	1	1	1	Weak																																												
4	1	RESERVED																																														
3	0	RESERVED																																														
2	1	RESERVED																																														
1	0	RESERVED																																														
0	0	RESERVED																																														

Byte 13: Control Register 13

Bit	@Pup	Name	Description
7	1	RESERVED	RESERVED
6	0	RESERVED	RESERVED
5	1	RESERVED	RESERVED
4	0	RESERVED	RESERVED
3	0	RESERVED	RESERVED
2	0	RESERVED	RESERVED
1	0	RESERVED	RESERVED

0	0	Wireless Friendly mode	Wireless Friendly Mode 0 = Disabled, Default all single-ended clocks slew rate config bits to '101' 1 = Enabled, Default all single-ended clocks slew rate config bits to '111'
---	---	------------------------	---

Byte 14: Control Register 14

Bit	@Pup	Name	Description
7	1	RESERVED	RESERVED
6	0	RESERVED	RESERVED
5	1	RESERVED	RESERVED
4	0	OTP_4	OTP_ID Identification for programmed device
3	0	OTP_3	
2	0	OTP_2	
1	0	OTP_1	
0	0	OTP_0	

Programmable frequency clarification

SL28PCle30 allows flexibility of programming a frequency to two single ended outputs - Prog_SE1 and Prog_SE2 respectively.

Both Prog_SE1 and Prog_SE2 can be factory programmed to any frequency as required by the end user with a 3.3V swing single ended output. Prog_SE1 clock can have a feature of Spread Spectrum to reduce EMI where as Prog_SE2 is a non-spread option.

Absolute Maximum Conditions

Parameter	Description	Condition	Min.	Max.	Unit
V _{DD_3.3V}	Main Supply Voltage	Functional	–	4.6	V
V _{IN}	Input Voltage	Relative to V _{SS}	–0.5	4.6	V _{DC}
T _S	Temperature, Storage	Non-functional	–65	150	°C
T _A	Temperature, Operating Ambient, Commercial	Functional	0	85	°C
T _A	Temperature, Operating Ambient, Industrial	Functional	–40	85	°C
T _J	Temperature, Junction	Functional	–	150	°C
∅ _{JC}	Dissipation, Junction to Case	JEDEC (JESD 51)	–	20	°C/W
∅ _{JA}	Dissipation, Junction to Ambient	JEDEC (JESD 51)	–	60	°C/W
ESD _{HBM}	ESD Protection (Human Body Model)	JEDEC (JESD 22 - A114)	2000	–	V
UL-94	Flammability Rating	UL (Class)	V-0		

Multiple Supplies: The Voltage on any input or I/O pin cannot exceed the power pin during power-up. Power supply sequencing is NOT required.

DC Electrical Specifications

Parameter	Description	Condition	Min.	Max.	Unit
V _{DD core}	3.3V Operating Voltage	3.3 ± 5%	3.135	3.465	V
V _{IH}	3.3V Input High Voltage (SE)		2.0	V _{DD} + 0.3	V
V _{IL}	3.3V Input Low Voltage (SE)		V _{SS} – 0.3	0.8	V
V _{IHI2C}	Input High Voltage	SDATA, SCLK	2.2	–	V
V _{ILI2C}	Input Low Voltage	SDATA, SCLK	–	1.0	V
V _{IH_FS}	FS Input High Voltage		0.7	V _{DD} +0.3	V
V _{IL_FS}	FS Input Low Voltage		V _{SS} –0.3	0.35	V
I _{IH}	Input High Leakage Current	Except internal pull-down resistors, 0 < V _{IN} < V _{DD}	–	5	μA
I _{IL}	Input Low Leakage Current	Except internal pull-up resistors, 0 < V _{IN} < V _{DD}	–5	–	μA
V _{OH}	3.3V Output High Voltage (SE)	I _{OH} = –1 mA	2.4	–	V
V _{OL}	3.3V Output Low Voltage (SE)	I _{OL} = 1 mA	–	0.4	V
I _{OZ}	High-impedance Output Current		–10	10	μA
C _{IN}	Input Pin Capacitance		1.5	5	pF
C _{OUT}	Output Pin Capacitance			6	pF
L _{IN}	Pin Inductance		–	7	nH
I _{DD_3.3V}	Dynamic Supply Current	All outputs enabled. SE clocks with 8" traces. Differential clocks with 7" traces.	–	100	mA



AC Electrical Specifications

Parameter	Description	Condition	Min.	Max.	Unit
Crystal					
L _{ACC}	Long-term Accuracy	Measured at VDD/2 differential	-	250	ppm
Clock Input					
T _{DC}	CLKIN Duty Cycle	Measured at VDD/2	47	53	%
T _R /T _F	CLKIN Rise and Fall Times	Measured between 0.2V _{DD} and 0.8V _{DD}	0.5	4.0	V/ns
T _{CCJ}	CLKIN Cycle to Cycle Jitter	Measured at VDD/2	-	250	ps
T _{LTJ}	CLKIN Long Term Jitter	Measured at VDD/2	-	350	ps
V _{IH}	Input High Voltage	XIN / CLKIN pin	2	VDD+0.3	V
V _{IL}	Input Low Voltage	XIN / CLKIN pin	-	0.8	V
I _{IH}	Input High Current	XIN / CLKIN pin, VIN = VDD	-	35	uA
I _{IL}	Input Low Current	XIN / CLKIN pin, 0 < VIN < 0.8	-35	-	uA
SRC at 0.7V					
T _{DC}	SRC Duty Cycle	Measured at 0V differential	45	55	%
T _{SKEW(window)}	Any SRC Clock Skew from the earliest bank to the latest bank	Measured at 0V differential	-	3.0	ns
T _{CCJ}	SRC Cycle to Cycle Jitter	Measured at 0V differential	-	125	ps
RMS _{GEN1}	Output PCIe* Gen1 REFCLK phase jitter	BER = 1E-12 (including PLL BW 8 - 16 MHz, ζ = 0.54, Td=10 ns, Ftrk=1.5 MHz)	0	108	ps
RMS _{GEN2}	Output PCIe* Gen2 REFCLK phase jitter	Includes PLL BW 8 - 16 MHz, Jitter Peaking = 3dB, ζ = 0.54, Td=10 ns), Low Band, F < 1.5MHz	0	3.0	ps
RMS _{GEN2}	Output PCIe* Gen2 REFCLK phase jitter	Includes PLL BW 8 - 16 MHz, Jitter Peaking = 3dB, ζ = 0.54, Td=10 ns), Low Band, F < 1.5MHz	0	3.1	ps
L _{ACC}	SRC Long Term Accuracy	Measured at 0V differential	-	100	ppm
T _R / T _F	SRC Rising/Falling Slew Rate	Measured differentially from ±150 mV	2.5	8	V/ns
V _{HIGH}	Voltage High			1.15	V
V _{LOW}	Voltage Low		-0.3	-	V
V _{OX}	Crossing Point Voltage at 0.7V Swing		300	550	mV
V _{LOW}	Voltage Low		-0.3	-	V
V _{OX}	Crossing Point Voltage at 0.7V Swing		300	550	mV
Prog_SE1 at 3.3V					
T _{DC}	Duty Cycle	Measurement at 1.5V	45	55	%
T _R / T _F	Rising/Falling Slew Rate	Measured between 0.8V and 2.0V	1.0	4.0	V/ns
T _{CCJ}	Cycle to Cycle Jitter	Measurement at 1.5V	-	300	ps
L _{ACC}	Long Term Accuracy	Measurement at 1.5V	-	100	ppm
Prog_SE2 at 3.3V					
T _{DC}	Duty Cycle	Measurement at 1.5V	45	55	%
T _R / T _F	Rising/Falling Slew Rate	Measured between 0.8V and 2.0V	1.0	4.0	V/ns
T _{CCJ}	Cycle to Cycle Jitter	Measurement at 1.5V	-	300	ps
L _{ACC}	Long Term Accuracy	Measurement at 1.5V	-	100	ppm



AC Electrical Specifications (continued)

Parameter	Description	Condition	Min.	Max.	Unit
25M at 3.3V					
T _{DC}	Duty Cycle	Measurement at 1.5V	45	55	%
T _R / T _F	Rising and Falling Edge Rate	Measured between 0.8V and 2.0V	1.0	4.0	V/ns
T _{CCJ}	Cycle to Cycle Jitter	Measurement at 1.5V	–	350	ps
L _{ACC}	Long Term Accuracy	Measured at 1.5V	–	100	ppm
ENABLE/DISABLE and SET-UP					
T _{STABLE}	Clock Stabilization from Power-up		–	1.8	ms
T _{SS}	Stopclock Set-up Time		10.0	–	ns

Test and Measurement Set-up

For Single Ended Clocks

The following diagram shows the test load configurations for the single-ended output signals.

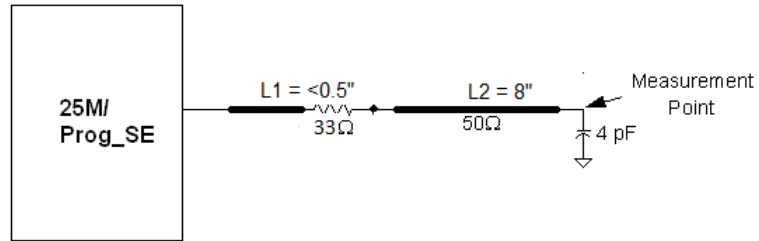

Figure 1. Single-ended clocks Single Load Configuration

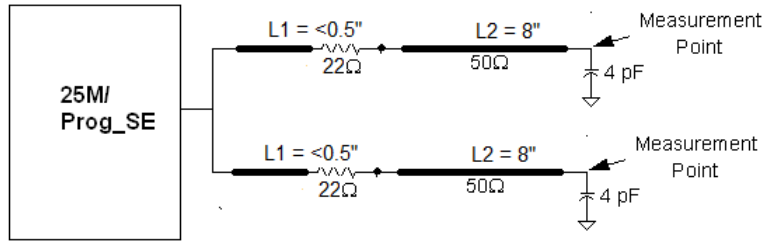

Figure 2. Single-ended clocks Double Load Configuration

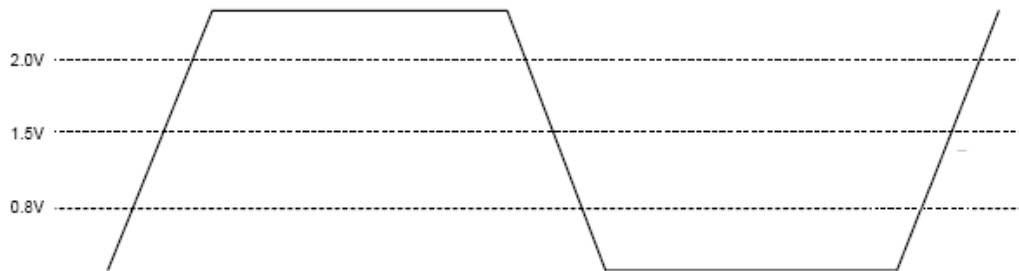

Figure 3. Single-ended Output Signals (for AC Parameters Measurement)

For Differential Clock Signals

This diagram shows the test load configuration for the differential clock signals

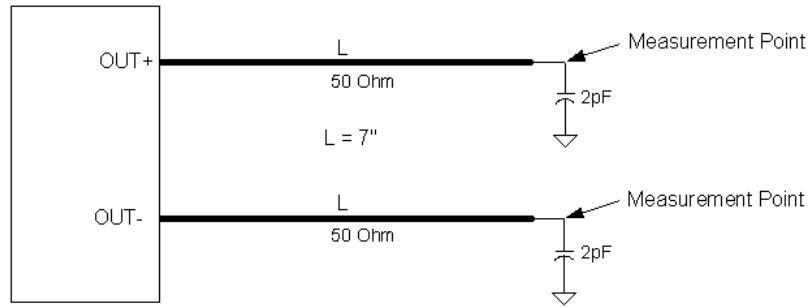

Figure 4. 0.7V Differential Load Configuration

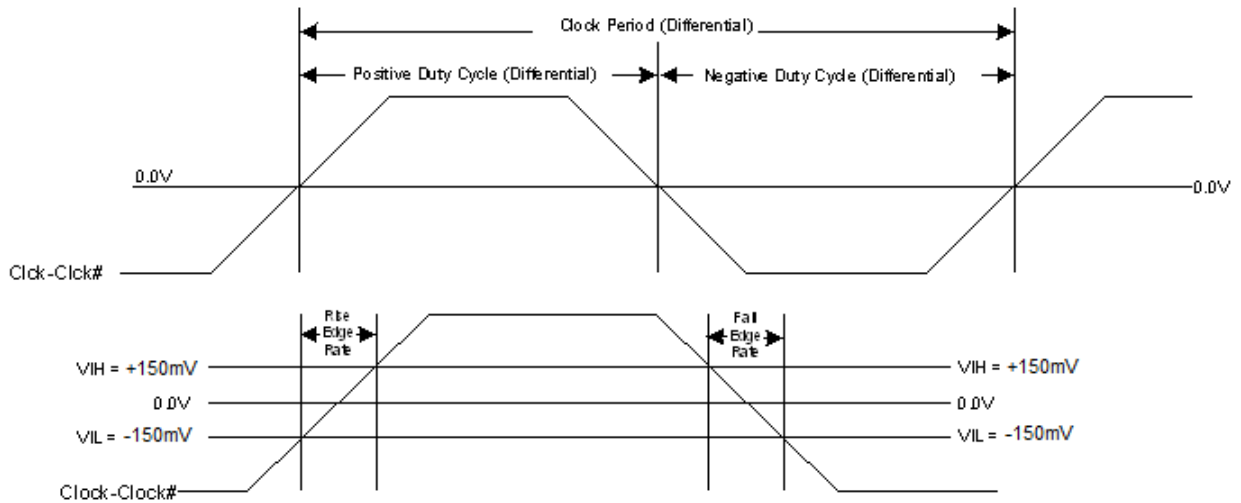

Figure 5. Differential Measurement for Differential Output Signals (for AC Parameters Measurement)

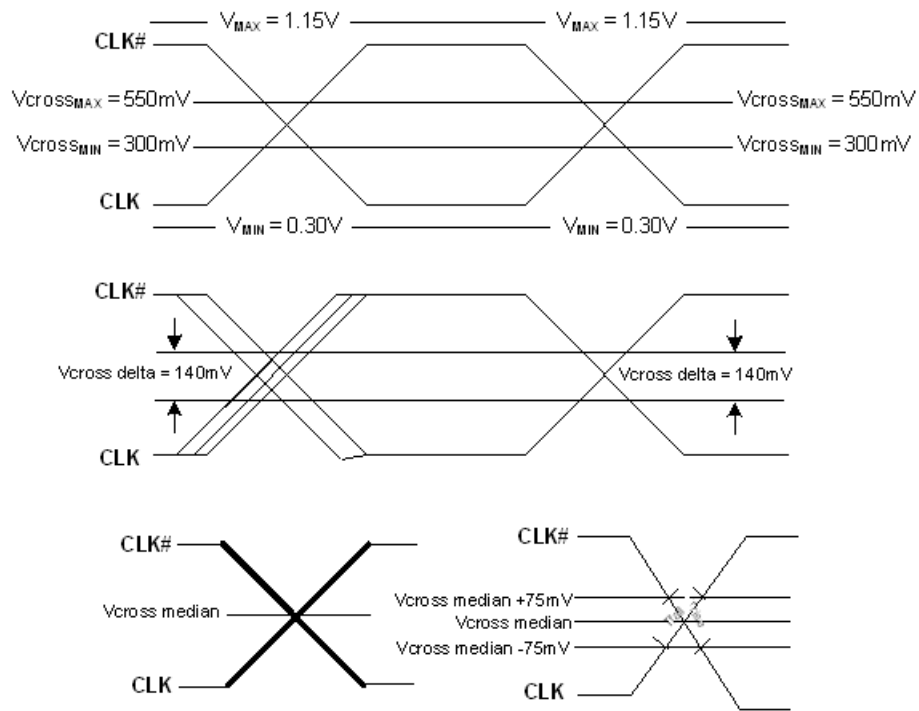

Figure 6. Single-ended Measurement for Differential Output Signals (for AC Parameters Measurement)

Ordering Information

Part Number	Package Type	Product Flow
Lead-free		
SL28PCle30ALC	32-pin QFN	Commercial, 0° to 85°C
SL28PCle30ALCT	32-pin QFN – Tape and Reel	Commercial, 0° to 85°C
SL28PCle30ALI	32-pin QFN	Industrial, -40° to 85°C
SL28PCle30ALIT	32-pin QFN – Tape and Reel	Industrial, -40° to 85°C

Package Diagrams

32-Lead QFN 5x 5mm

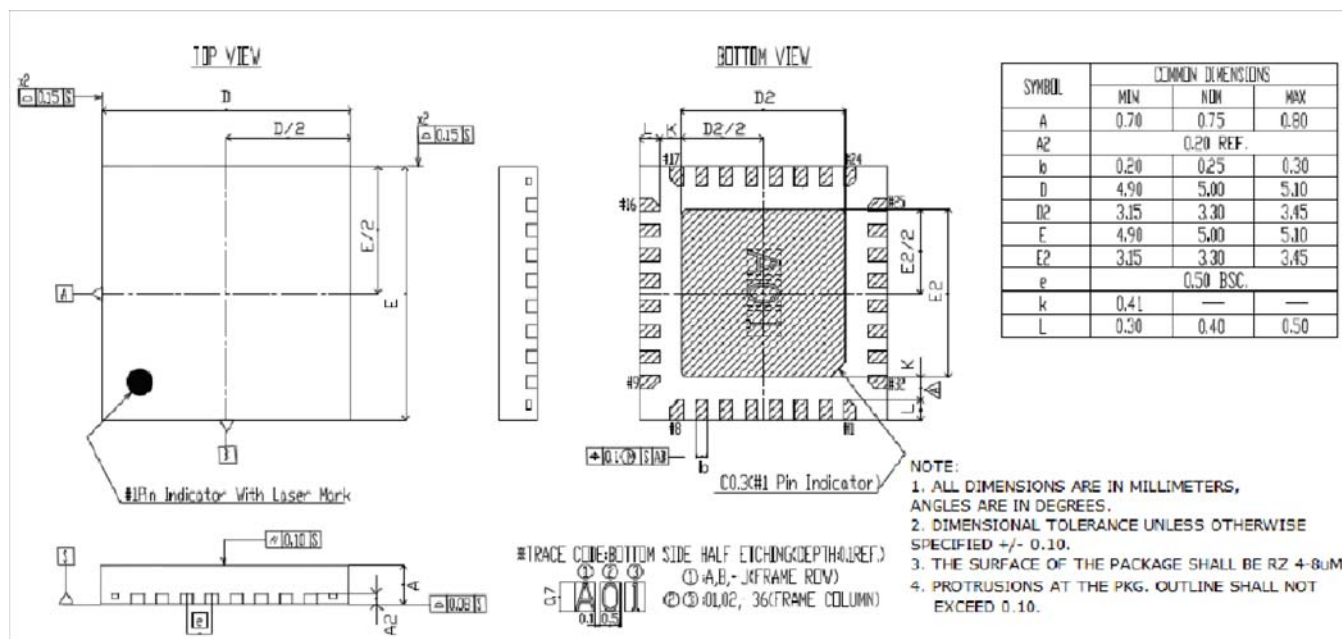

Document History Page

Document Title: SL28PCle30 PC EProClock[®] Programmable PCIe Gen 2 Clock Generator			
DOC#: SP-AP-0775 (Rev. 0.2)			
REV.	Issue Date	Orig. of Change	Description of Change
AA	11/7/10	TRP	Initial Release
AA	12/7/10	TRP	1. Updated datasheet title 2. Added feature of PCIe Gen1 and Gen2 compliance

The information in this document is believed to be accurate in all respects at the time of publication but is subject to change without notice. Silicon Laboratories assumes no responsibility for errors and omissions, and disclaims responsibility for any consequences resulting from the use of information included herein. Additionally, Silicon Laboratories assumes no responsibility for the functioning of undescribed features or parameters. Silicon Laboratories reserves the right to make changes without further notice. Silicon Laboratories makes no warranty, representation or guarantee regarding the suitability of its products for any particular purpose, nor does Silicon Laboratories assume any liability arising out of the application or use of any product or circuit, and specifically disclaims any and all liability, including without limitation consequential or incidental damages. Silicon Laboratories products are not designed, intended, or authorized for use in applications intended to support or sustain life, or for any other application in which the failure of the Silicon Laboratories product could create a situation where personal injury or death may occur. Should Buyer purchase or use Silicon Laboratories products for any such unintended or unauthorized application, Buyer shall indemnify and hold Silicon Laboratories harmless against all claims and damages.