

MAXIM

SC70/SOT23-8, 50mA I_{OUT}, Rail-to-Rail I/O Op Amps with Shutdown/Mute

General Description

The MAX4335–MAX4338 op amps deliver 40mW per channel into 32Ω from ultra-small SC70/SOT23 packages making them ideal for mono/stereo headphone drivers in portable applications. These amplifiers have a 5MHz gain-bandwidth product and are guaranteed to deliver 50mA of output current while operating from a single supply of 2.7V to 5.5V.

The MAX4336 and the MAX4338 have a shutdown/mute mode that reduces the supply current to 0.04μA per amplifier and places the outputs in a high-impedance state.

The MAX4335–MAX4338 have 90dB power-supply rejection ratio (PSRR), eliminating the need for costly pre-regulation in most audio applications. Both the input voltage range and the output voltage swing include both supply rails, maximizing dynamic range.

The MAX4335/MAX4336 single amplifiers are available in ultra-small 6-pin SC70 packages. The MAX4337/MAX4338 dual amplifiers are available in an 8-pin SOT23 and a 10-pin μMAX package, respectively. All devices are specified from -40°C to +85°C.

Applications

32Ω Headphone Drivers
 Portable/Battery-Powered Instruments
 Wireless PA Control
 Hands-Free Car Phones
 Transformer/Line Drivers
 DAC/ADC Buffers

Typical Operating Circuit

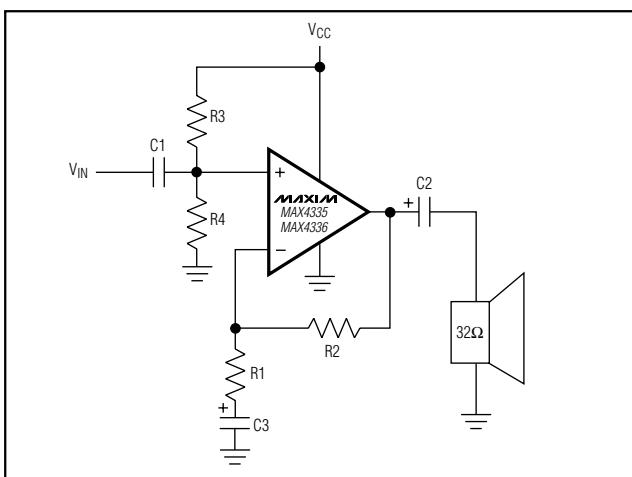

Rail-to-Rail is a registered trademark of Nippon Motorola Ltd.

Features

- ◆ 50mA Output Drive Capability
- ◆ Low 0.003% THD (20kHz into 10kΩ)
- ◆ Rail-to-Rail® Inputs and Outputs
- ◆ 2.7V to 5.5V Single-Supply Operation
- ◆ 5MHz Gain-Bandwidth Product
- ◆ 95dB Large-Signal Voltage Gain
- ◆ 90dB Power-Supply Rejection Ratio
- ◆ No Phase Reversal for Overdrive Inputs
- ◆ Ultra-Low Power Shutdown/Mute Mode
 - Reduces Supply Current to 0.04μA
 - Places Output in High-Impedance State
- ◆ Thermal Overload Protection

Ordering Information

PART	TEMP RANGE	PIN-PACKAGE	TOP MARK
MAX4335EXT-T	-40°C to +85°C	6 SC70-6	AAX
MAX4336EXT-T	-40°C to +85°C	6 SC70-6	AAW
MAX4337EKA-T	-40°C to +85°C	8 SOT23-8	AAIK
MAX4337EUA	-40°C to +85°C	8 μMAX	—
MAX4338EUB	-40°C to +85°C	10 μMAX	—

Pin Configurations appear at end of data sheet.

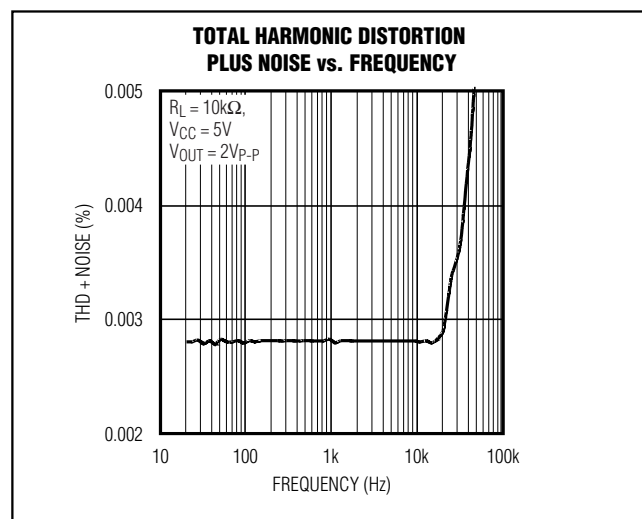
**MAXIM**

Maxim Integrated Products 1

For pricing, delivery, and ordering information, please contact Maxim/Dallas Direct! at 1-888-629-4642, or visit Maxim's website at www.maxim-ic.com.

MAX4335-MAX4338

SC70/SOT23-8, 50mA IOUT, Rail-to-Rail I/O Op Amps with Shutdown/Mute

ABSOLUTE MAXIMUM RATINGS

Supply Voltage (V _{CC} to GND)	-0.3V to +6V	8-Pin μMAX (derate 4.5mW/°C above +70°C)	362mW
All Other Pins to GND	(GND - 0.3V) to (V _{CC} + 0.3V)	10-Pin μMAX (derate 5.6mW/°C above +70°C)	444mW
Output Short-Circuit Duration to V _{CC} or GND	Continuous	Operating Temperature Range	-40°C to +85°C
Continuous Power Dissipation (T _A = +70°C)		Junction Temperature	+150°C
6-Pin SC70 (derate 3.1mW/°C above +70°C)	245mW	Storage Temperature Range	-65°C to +150°C
8-Pin SOT23 (derate 9.1mW/°C above +70°C)	727mW	Lead Temperature (soldering, 10s)	+300°C

Stresses beyond those listed under "Absolute Maximum Ratings" may cause permanent damage to the device. These are stress ratings only, and functional operation of the device at these or any other conditions beyond those indicated in the operational sections of the specifications is not implied. Exposure to absolute maximum rating conditions for extended periods may affect device reliability.

DC ELECTRICAL CHARACTERISTICS

(V_{CC} = 2.7V, GND = 0, V_{CM} = 0, V_{OUT} = V_{CC}/2, R_L = ∞ to V_{CC}/2, V_{SHDN} = V_{CC}, T_A = +25°C, unless otherwise noted.)

PARAMETER	SYMBOL	CONDITIONS	MIN	TYP	MAX	UNITS
Operating Supply Voltage Range	V _{CC}	Inferred from PSRR Test	2.7		5.5	V
Quiescent Supply Current (Per Amplifier)	I _{CC}	V _{CC} = 5.5V		1.3	1.8	mA
		V _{CC} = 2.7		1.2		
Input Offset Voltage	V _{OS}	V _{CM} = GND to V _{CC}		±0.6	±3	mV
Input Bias Current	I _B	V _{CM} = GND to V _{CC}		±100	±400	nA
Input Offset Current	I _{OS}	V _{CM} = GND to V _{CC}		±7	±30	nA
Differential Input Resistance	R _{IN(Diff)}	V _{IN-} - V _{IN+} < 1.2V		500		kΩ
		V _{IN-} - V _{IN+} > 1.2V		8.4		
Input Common-Mode Voltage Range	V _{CM}	Inferred from CMRR Test	GND		V _{CC}	V
Common-Mode Rejection Ratio	CMRR	V _{CM} = GND to V _{CC}	60	80		dB
Power-Supply Rejection Ratio	PSRR	V _{CC} = 2.7V to 5.5V	70	90		dB
Output Resistance	R _{OUT}	AV _{CL} = 1V/V		0.05		Ω
Large-Signal Voltage Gain	AV _{OL}	V _{CC} = 5V; R _L = 10kΩ V _{OUT} = 0.4V to 4.6V		95		dB
		V _{CC} = 5V; R _L = 100Ω V _{OUT} = 0.5V to 4.5V	70	84		
		V _{CC} = 2.7V; R _L = 32Ω V _{OUT} = 0.5V to 2.2V	62	72		
Output Voltage Swing	V _{OUT}	V _{CC} = 2.7V; R _L = 10kΩ	V _{CC} - V _{OH}	100		mV
			V _{OL}	100		
		V _{CC} = 2.7V; R _L = 32Ω	V _{CC} - V _{OH}	220	400	
			V _{OL}	280	400	
		V _{CC} = 5V; R _L = 10kΩ	V _{CC} - V _{OH}	100		
			V _{OL}	100		
		V _{CC} = 5V; R _L = 100Ω	V _{CC} - V _{OH}	190	350	
			V _{OL}	240	350	

SC70/SOT23-8, 50mA I_{OUT}, Rail-to-Rail I/O Op Amps with Shutdown/Mute

MAX4335-MAX4338

DC ELECTRICAL CHARACTERISTICS (continued)

(V_{CC} = 2.7V, GND = 0, V_{CM} = 0, V_{OUT} = V_{CC}/2, R_L = ∞ to V_{CC}/2, V_{SHDN} = V_{CC}, T_A = +25°C, unless otherwise noted.)

PARAMETER	SYMBOL	CONDITIONS	MIN	TYP	MAX	UNITS
Output Drive	I _{OUT}	V _{CC} = 2.7V; I _{SOURCE} , I _{SINK} = 50mA	V _{CC} - V _{OH}	270	500	mV
			V _{OL}	360	500	
		V _{CC} = 5V; I _{SOURCE} , I _{SINK} = 50mA	V _{CC} - V _{OH}	270	500	
			V _{OL}	360	500	
Short-Circuit Current	I _{SC}		110		mA	
SHDN Logic Levels	V _{IH}	Normal mode	0.7 x V _{CC}		V	
	V _{IL}	Shutdown mode	0.3 x V _{CC}			
SHDN Leakage Current	I _{IL}	V _{CC} = 5V, GND < V _{SHDN} < V _{CC}		0.5	μA	
Output Leakage Current in Shutdown	I _{OUT(SHDN)}	V _{CC} = 5V, V _{SHDN} = 0, V _{OUT} = 0, V _{CC}		0.01	0.5	μA
Shutdown Supply Current (Per Amplifier)	I _{CC(SHDN)}	SHDN = GND; V _{CC} = 5V		<0.04	0.5	μA

DC ELECTRICAL CHARACTERISTICS

(V_{CC} = 2.7V, GND = 0, V_{CM} = 0, V_{OUT} = V_{CC}/2, R_L = ∞ to V_{CC}/2, V_{SHDN} = V_{CC}, T_A = -40°C to +85°C, unless otherwise noted.)
(Note 1)

PARAMETER	SYMBOL	CONDITIONS	MIN	TYP	MAX	UNITS
Operating Supply Voltage Range	V _{CC}	Inferred from PSRR test	2.7		5.5	V
Quiescent Supply Current (Per Amplifier)	I _{CC}	V _{CC} = 5.5V			2.25	mA
Input Offset Voltage	V _{OS}	V _{CM} = GND to V _{CC}			±6	mV
Input Bias Current	I _B	V _{CM} = GND to V _{CC}			±600	nA
Input Offset Current	I _{OS}	V _{CM} = GND to V _{CC}			±60	nA
Input Common-Mode Voltage Range	V _{CM}	Inferred from CMRR test	GND		V _{CC}	V
Common-Mode Rejection Ratio	CMRR	V _{CM} = GND to V _{CC}	50			dB
Power-Supply Rejection Ratio	PSRR	V _{CC} = 2.7V to 5.5V	64			dB
Large-Signal Voltage Gain	A _{VOL}	V _{CC} = 5V: R _L = 100Ω, V _{OUT} = 0.6V to 4.4V	66			dB
		V _{CC} = 2.7V: R _L = 32Ω, V _{OUT} = 0.6V to 2.1V	56			

SC70/SOT23-8, 50mA I_{OUT}, Rail-to-Rail I/O Op Amps with Shutdown/Mute

DC ELECTRICAL CHARACTERISTICS (continued)

(V_{CC} = 2.7V, GND = 0, V_{CM} = 0, V_{OUT} = V_{CC}/2, R_L = ∞ to V_{CC}/2, V_{SHDN} = V_{CC}, T_A = -40°C to +85°C, unless otherwise noted.)
(Note 1)

PARAMETER	SYMBOL	CONDITIONS	MIN	TYP	MAX	UNITS
Output Voltage Swing	V _{OUT}	V _{CC} = 2.7V; R _L = 32Ω	V _{CC} - V _{OH}		500	mV
			V _{OL}		500	
		V _{CC} = 5V; R _L = 100Ω	V _{CC} - V _{OH}		400	
			V _{OL}		400	
Output Drive	I _{OUT}	V _{CC} = 2.7V; I _{SOURCE} , I _{SINK} = 50mA	V _{CC} - V _{OH}		650	mV
			V _{OL}		650	
		V _{CC} = 5V; I _{SOURCE} , I _{SINK} = 50mA	V _{CC} - V _{OH}		650	
			V _{OL}		650	
SHDN Logic Level	V _{IH}	Normal mode	0.7 × V _{CC}			V
	V _{IL}	Shutdown mode	0.3 × V _{CC}			
SHDN Leakage Current	I _{IL}	V _{CC} = 5V, GND < V _{SHDN} < V _{CC}			1	μA
Output Leakage Current in Shutdown	I _{OUT(SHDN)}	V _{CC} = 5V, V _{SHDN} = 0, V _{OUT} = 0; V _{CC}			1	μA
Shutdown Supply Current (Per Amplifier)	I _{CC(SHDN)}	V _{SHDN} = 0; V _{CC} = 5V			1	μA

AC ELECTRICAL CHARACTERISTICS

(V_{CC} = 2.7V, GND = 0, V_{CM} = V_{CC}/2, V_{OUT} = V_{CC}/2, V_{SHDN} = V_{CC}, A_{VCL} = 1V/V, C_L = 15pF, R_L = ∞ to V_{CC}/2, T_A = +25°C, unless otherwise noted.)

PARAMETER	SYMBOL	CONDITIONS	MIN	TYP	MAX	UNITS
Gain-Bandwidth Product	GBWP			5		MHz
Full-Power Bandwidth	FBWP	V _{OUT} = 2V _{P-P} , V _{CC} = 5V		280		kHz
Slew Rate	SR			1.8		V/μs
Phase Margin	PM			70		degrees
Gain Margin	GM			18		dB
Total Harmonic Distortion	THD	V _{CC} = 5V, R _L = 100Ω, V _{OUT} = 2V _{P-P}	f = 1kHz		0.005	%
			f = 10kHz		0.02	
		V _{CC} = 5V, R _L = 10kΩ, V _{OUT} = 2V _{P-P} , f = 10kHz			0.003	
			V _{CC} = 2.7V; R _L = 32Ω, V _{OUT} = 2V _{P-P}	f = 1kHz		
f = 10kHz		0.03				

SC70/SOT23-8, 50mA IOUT, Rail-to-Rail I/O Op Amps with Shutdown/Mute

MAX4335-MAX4338

AC ELECTRICAL CHARACTERISTICS (continued)

($V_{CC} = +2.7V$, $GND = 0$, $V_{CM} = V_{CC}/2$, $V_{OUT} = V_{CC}/2$, $V_{SHDN} = V_{CC}$, $A_{VCL} = 1V/V$, $C_L = 15pF$, $R_L = \infty$ to $V_{CC}/2$, $T_A = +25^{\circ}C$, unless otherwise noted.)

PARAMETER	SYMBOL	CONDITIONS	MIN	TYP	MAX	UNITS
Settling Time to 0.01%	t_s	2V step		2		μs
Crosstalk	CT	$V_{OUT} = 2V_{P-P}$; $f = 1kHz$		100		dB
Input Capacitance	C_{IN}			5		pF
Input Voltage-Noise Density	e_n	$f = 10kHz$		26		nV/\sqrt{Hz}
		$f = 1kHz$				
Input Current-Noise Density	i_n	$f = 10kHz$		0.6		pA/\sqrt{Hz}
		$f = 1kHz$				
Capacitive-Load Stability		No sustained oscillation		200		pF
Shutdown Time	t_{SHDN}			1		μs
Enable Time from Shutdown	t_{ENABLE}			1		μs
Power-Up Time	t_{ON}			5		μs

Note 1: All devices are 100% production tested at $T_A = +25^{\circ}C$. All limits over temperature are guaranteed by design.

Typical Operating Characteristics

($V_{CC} = 2.7V$, $GND = 0$, $V_{CM} = 0$, $V_{OUT} = V_{CC}/2$, $R_L = \infty$ to $V_{CC}/2$, $V_{SHDN} = V_{CC}$, $T_A = +25^{\circ}C$, unless otherwise noted.)

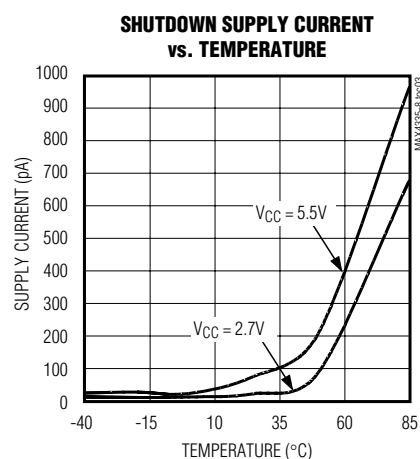
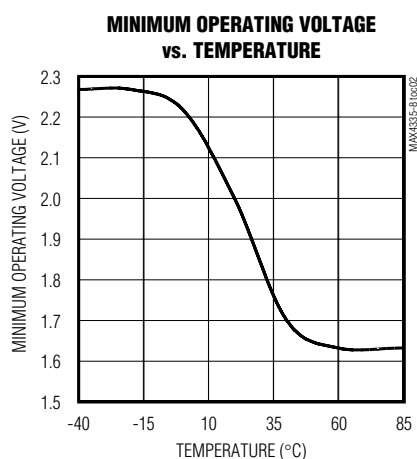
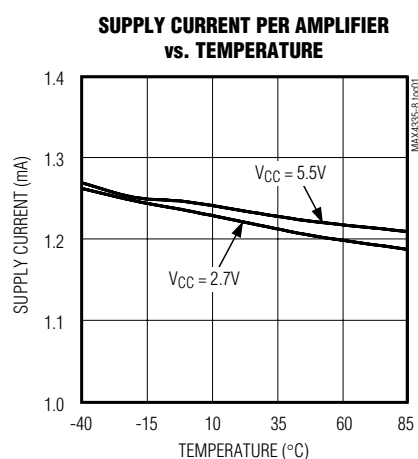

SC70/SOT23-8, 50mA I_{OUT}, Rail-to-Rail I/O Op Amps with Shutdown/Mute

Typical Operating Characteristics (continued)

(V_{CC} = 2.7V, GND = 0, V_{CM} = 0, V_{OUT} = V_{CC}/2, R_L = ∞ to V_{CC}/2, V_{SHDN} = V_{CC}, T_A = +25°C, unless otherwise noted.)

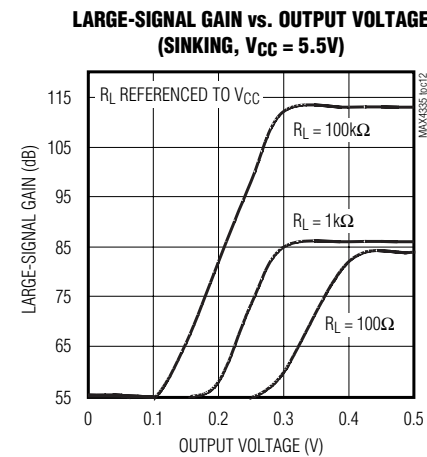
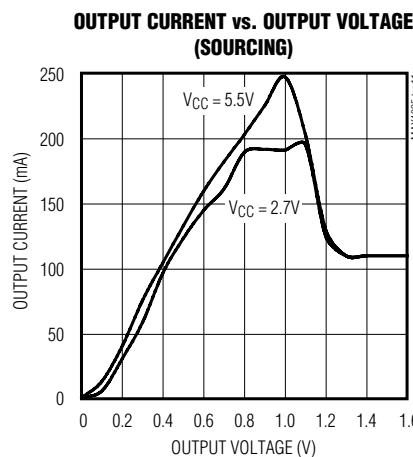
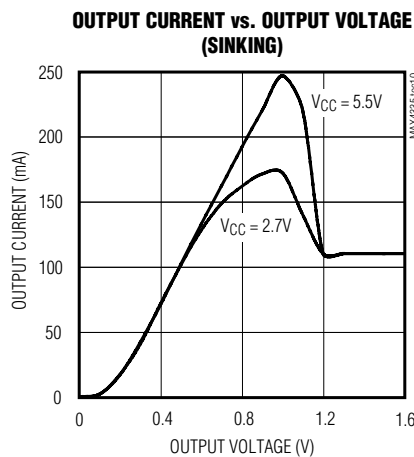
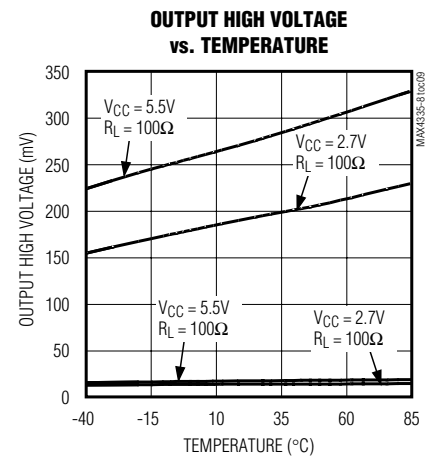
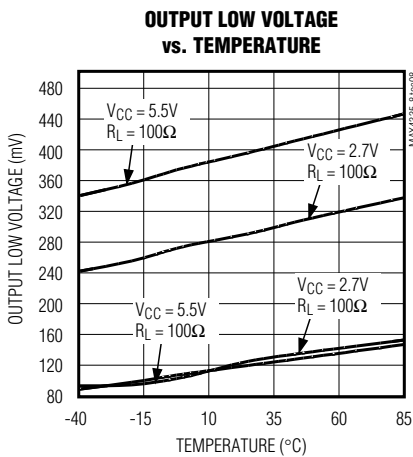
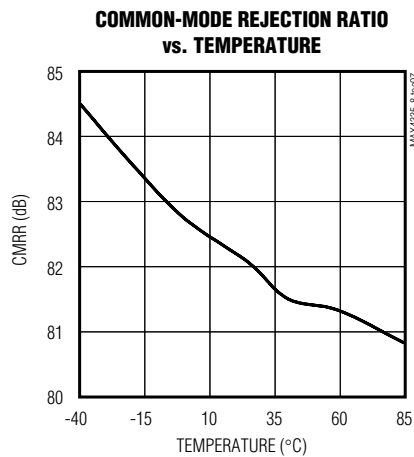
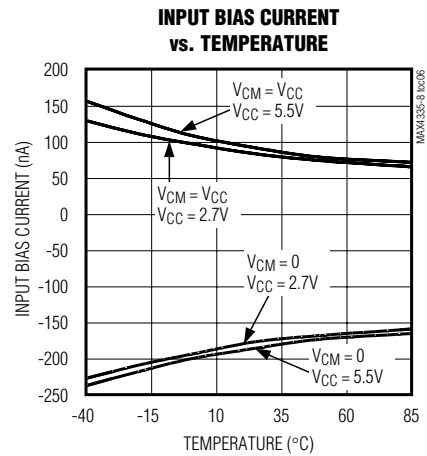
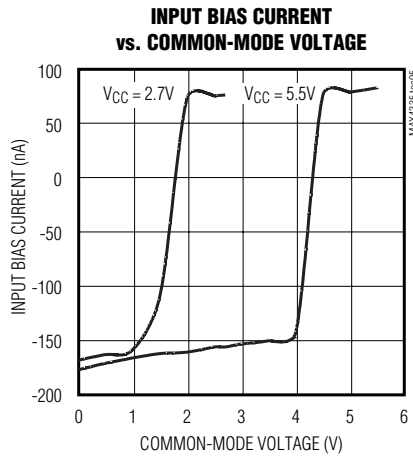
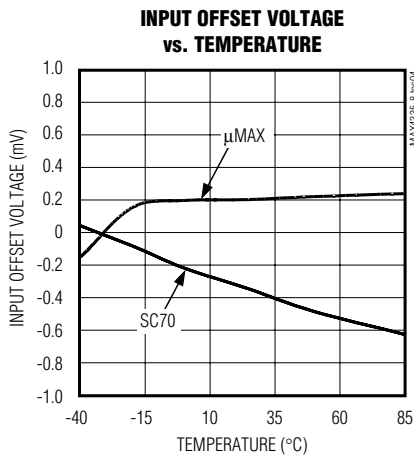

SC70/SOT23-8, 50mA I_{OUT}, Rail-to-Rail I/O Op Amps with Shutdown/Mute

Typical Operating Characteristics (continued)

(V_{CC} = 2.7V, GND = 0, V_{CM} = 0, V_{OUT} = V_{CC}/2, R_L = ∞ to V_{CC}/2, V_{SHDN} = V_{CC}, T_A = +25°C, unless otherwise noted.)

MAX4335-MAX4338

LARGE-SIGNAL GAIN vs. OUTPUT VOLTAGE (SOURCING, V_{CC} = 5.5V)

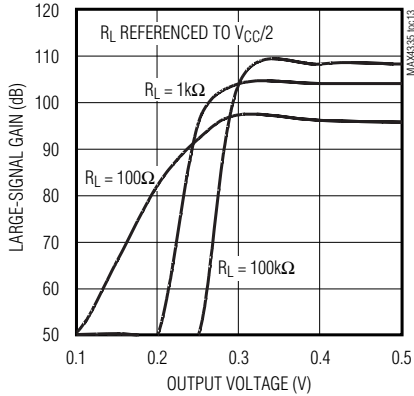

LARGE-SIGNAL GAIN vs. OUTPUT VOLTAGE (SINKING, V_{CC} = 2.7V)

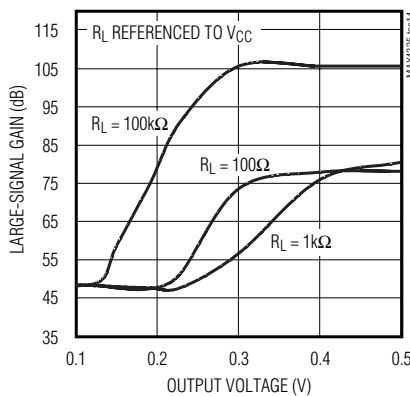

LARGE-SIGNAL GAIN vs. OUTPUT VOLTAGE (SOURCING, V_{CC} = 2.7V)

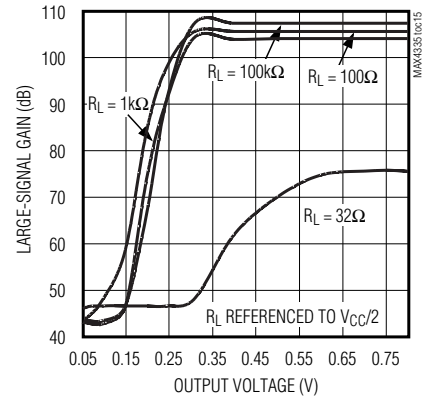

LARGE-SIGNAL GAIN vs. TEMPERATURE

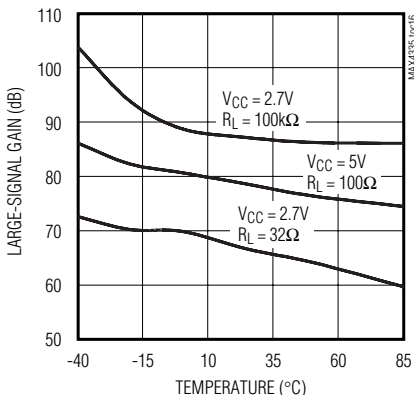

GAIN AND PHASE vs. FREQUENCY

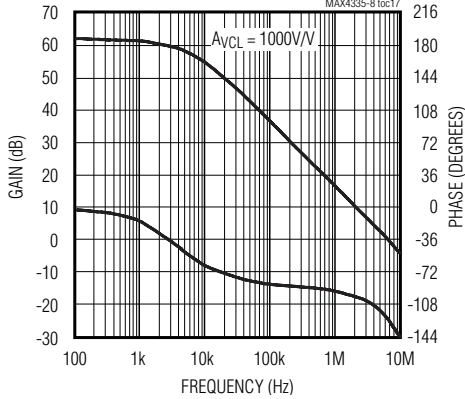

GAIN AND PHASE vs. FREQUENCY (C_L = 200pF)

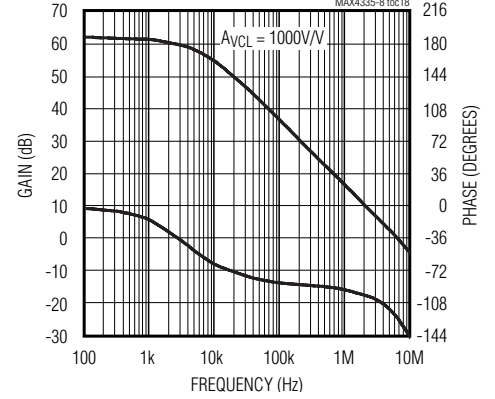

POWER-SUPPLY REJECTION RATIO vs. FREQUENCY

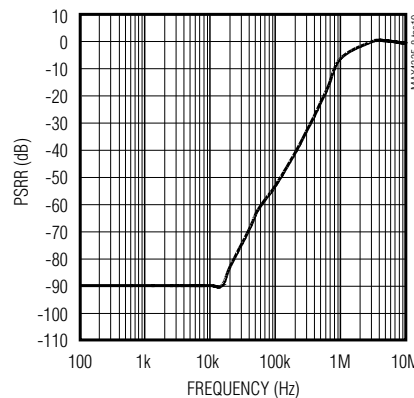

OUTPUT IMPEDANCE vs. FREQUENCY

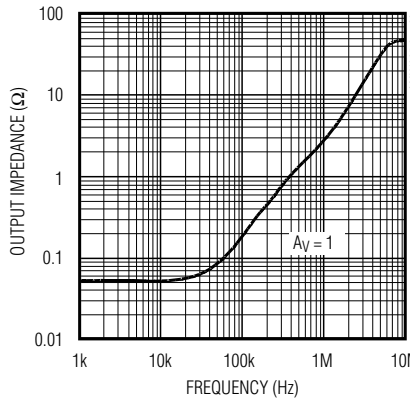

TOTAL HARMONIC DISTORTION AND NOISE vs. FREQUENCY

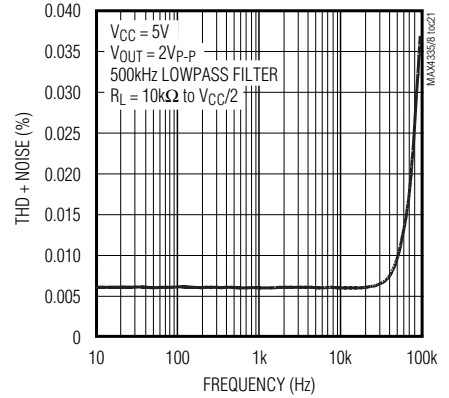

SC70/SOT23-8, 50mA I_{OUT}, Rail-to-Rail I/O Op Amps with Shutdown/Mute

Typical Operating Characteristics (continued)

(V_{CC} = 2.7V, GND = 0, V_{CM} = 0, V_{OUT} = V_{CC}/2, R_L = ∞ to V_{CC}/2, V_{SHDN} = V_{CC}, T_A = +25°C, unless otherwise noted.)

TOTAL HARMONIC DISTORTION PLUS NOISE vs. PEAK-TO-PEAK OUTPUT VOLTAGE

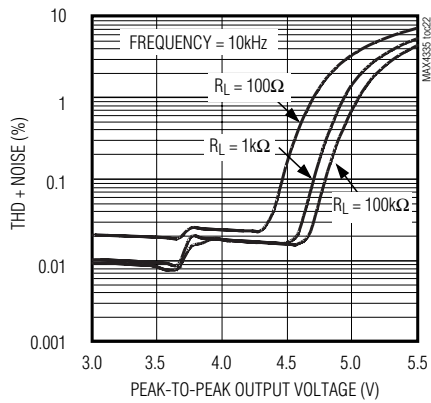

CHANNEL-TO-CHANNEL ISOLATION vs. FREQUENCY

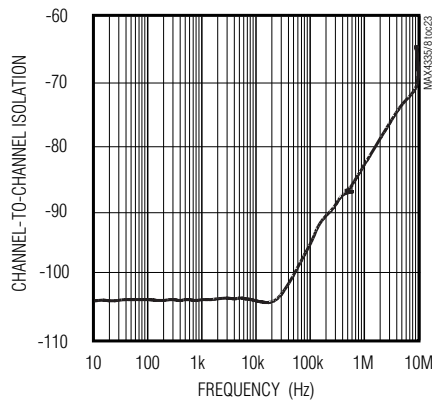

SMALL-SIGNAL TRANSIENT RESPONSE (NONINVERTING)

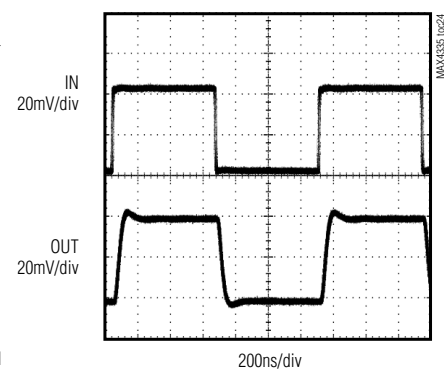

SMALL-SIGNAL TRANSIENT RESPONSE (INVERTING)

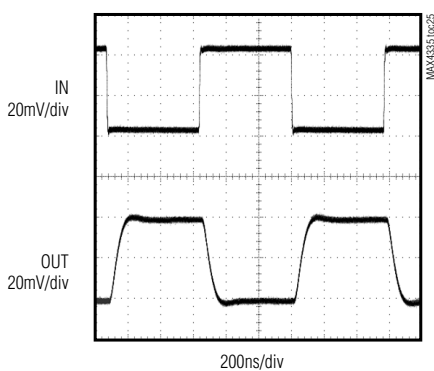

LARGE-SIGNAL TRANSIENT RESPONSE (NONINVERTING)

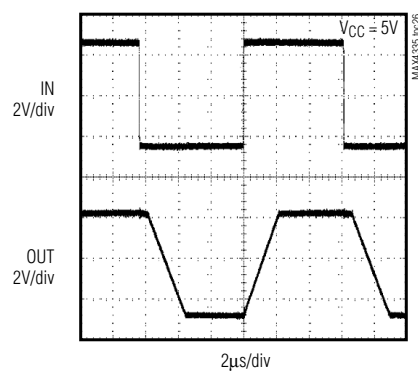

LARGE-SIGNAL TRANSIENT RESPONSE (INVERTING)

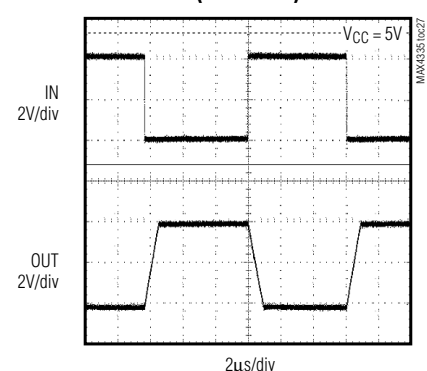

SC70/SOT23-8, 50mA I_{OUT}, Rail-to-Rail I/O Op Amps with Shutdown/Mute

Typical Application Circuit

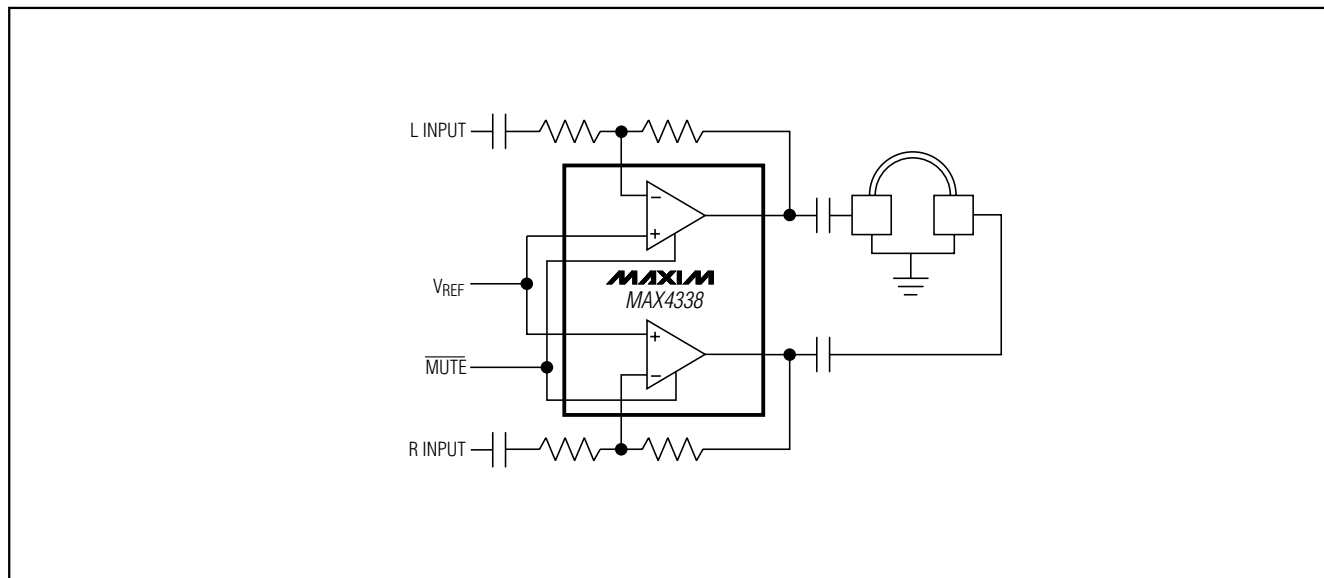

MAX4335-MAX4338

Pin Description

MAX4335	MAX4336	PIN			NAME	FUNCTION
		MAX4337		MAX4338		
		SOT23	μMAX			
1	1	3, 5	3, 5	3, 7	IN1 ⁺ , IN2 ⁺	Noninverting Input
2	2	4	4	4	GND	Ground
3	3	2, 6	2, 6	2, 8	IN2 ⁻ , IN1 ⁻	Inverting Input
4	4	1, 7	1, 7	1, 9	OUT1, OUT2	Output(s)
5	—	—	—	—	N.C.	No Connection. Not internally connected.
—	5	—	—	5, 6	$\overline{\text{SHDN1}}, \overline{\text{SHDN2}}$	Drive $\overline{\text{SHDN}}$ low for shutdown. Drive $\overline{\text{SHDN}}$ high or connect to V _{CC} for normal operation.
6	6	8	8	10	V _{CC}	Positive Supply

SC70/SOT23-8, 50mA I_{OUT}, Rail-to-Rail I/O Op Amps with Shutdown/Mute

Applications Information

Package Power Dissipation

Warning: Due to the high-output-current drive, this op amp can exceed the absolute maximum power-dissipation rating. As a general rule, as long as the peak current is less than or equal to 50mA, the maximum package power dissipation will not be exceeded for any of the package types offered. There are some exceptions to this rule, however. The absolute maximum power-dissipation rating of each package should always be verified using the following equations. The following equation gives an approximation of the package power dissipation:

$$P_{IC(DISS)} \cong V_{RMS} I_{RMS} \cos \theta$$

where: V_{RMS} = the RMS voltage from V_{CC} to V_{OUT} when sourcing current

= the RMS voltage from V_{OUT} to V_{EE} when sinking current

I_{RMS} = the RMS current flowing out of or into the op amp and the load

θ = the phase difference between the voltage and the current. For resistive loads, $\cos \theta = 1$.

For example, the circuit in Figure 1 has a package power dissipation of 220mW.

$$\begin{aligned} V_{RMS} &\cong (V_{CC} - V_{DC}) - \frac{V_{PEAK}}{\sqrt{2}} \\ &= 5.5V - 2.75V - \frac{1V}{\sqrt{2}} = 2.043V_{RMS} \\ I_{RMS} &\cong I_{DC} + \frac{I_{PEAK}}{\sqrt{2}} = \frac{2.75V}{32\Omega} + \frac{1V/32\Omega}{\sqrt{2}} \\ &= 108mA_{RMS} \end{aligned}$$

Therefore, $P_{IC(DISS)} = V_{RMS} I_{RMS} \cos \theta = 220mW$

Adding a coupling capacitor improves the package power dissipation because there is no DC current to the load, as shown in Figure 2.

$$\begin{aligned} V_{RMS} &\cong (V_{CC} - V_{DC}) - \frac{V_{PEAK}}{\sqrt{2}} \\ &= 5.5V - 2.75V - \frac{1V}{\sqrt{2}} = 2.043V_{RMS} \\ I_{RMS} &\cong I_{DC} + \frac{I_{PEAK}}{\sqrt{2}} = 0A + \frac{1V/32\Omega}{\sqrt{2}} \\ &= 22mA_{RMS} \end{aligned}$$

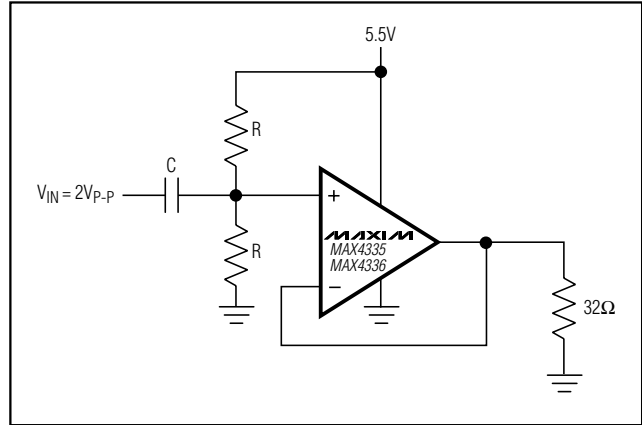

Figure 1. A Circuit Example where the MAX4335/MAX4336 is Dissipating High Power

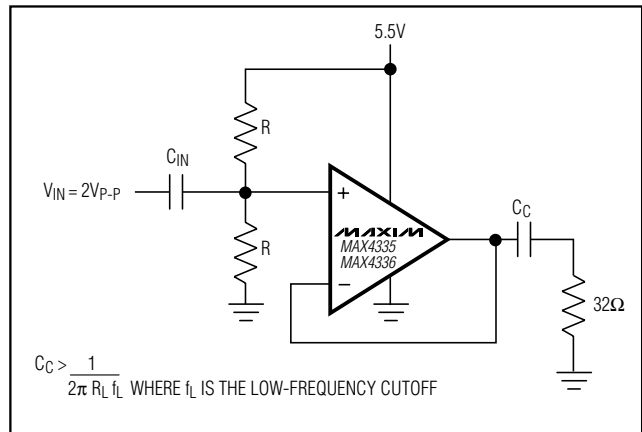

Figure 2. A Circuit Example where Adding a Coupling Capacitor Greatly Reduces the Power Dissipation of Its Package

$$\begin{aligned} \text{Therefore, } P_{IC(DISS)} &= V_{RMS} I_{RMS} \cos \theta \\ &= 45mW \end{aligned}$$

The absolute maximum power-dissipation rating of the package may be exceeded if the configuration in Figure 1 is used with the MAX4335/MAX4336 amplifiers at a high ambient temperature of 79°C (220.6mW/°C plus a derating of 3.1mW/°C x 9°C = 247.9mW). Note that the 247.9mW just exceeds the absolute maximum power dissipation of 245mW for the 6-pin SC70 package.

SC70/SOT23-8, 50mA IOUT, Rail-to-Rail I/O Op Amps with Shutdown/Mute

Single-Supply Speaker Driver

The MAX4335/MAX4336 can be used as a single-supply speaker driver, as shown in the *Typical Operating Circuit*. Capacitor C1 is used for blocking DC (a 0.1μF ceramic capacitor can be used). When choosing resistors R3 and R4, take into consideration the input bias current as well as how much supply current can be tolerated. Choose resistors R1 and R2 according to the amount of gain and current desired. Capacitor C3 ensures unity gain for DC. A 10μF electrolytic capacitor is suitable for most applications. The coupling capacitor C2 sets a low-frequency pole and is fairly large in value. For a 32Ω load, a 100μF coupling capacitor gives a low-frequency pole at 50Hz. The low-frequency pole can be set according to the following equation:

$$f = 1 / 2\pi (RLC2)$$

Rail-to-Rail Input Stage

Devices in the MAX4335–MAX4338 family of high-output-current amplifiers have rail-to-rail input and output stages designed for low-voltage, single-supply operation. The input stage consists of separate NPN and PNP differential stages that combine to provide an input common-mode range that extends 0.25V beyond the supply rails. The PNP stage is active for input voltages close to the negative rail, and the NPN stage is active for input voltages near the positive rail. The switchover transition region, which occurs near $V_{CC}/2$, has been extended to minimize the slight degradation in common-mode rejection ratio caused by mismatch of the input pairs.

Since the input stage switches between the NPN and PNP pairs, the input bias current changes polarity as the input voltage passes through the transition region. Match the effective impedance seen by each input to reduce the offset error caused by input bias currents flowing through external source impedances (Figures 3 and 5).

High source impedances, together with input capacitance, can create a parasitic pole that produces an underdamped signal response. Reducing the input impedance or placing a small (2pF to 10pF) capacitor across the feedback resistor improves response.

The MAX4335–MAX4338's inputs are protected from large differential input voltages by 1kΩ series resistors and back-to-back double diodes across the inputs (Figure 5).

For differential voltages less than 1.2V, input resistance is typically 500kΩ. For differential input voltages greater than 1.2V, input resistance is approximately 8.4kΩ. The input bias current is given by the following equation:

$$I_{BIAS} = (V_{DIFF} - 1.2V) / 8.4k\Omega$$

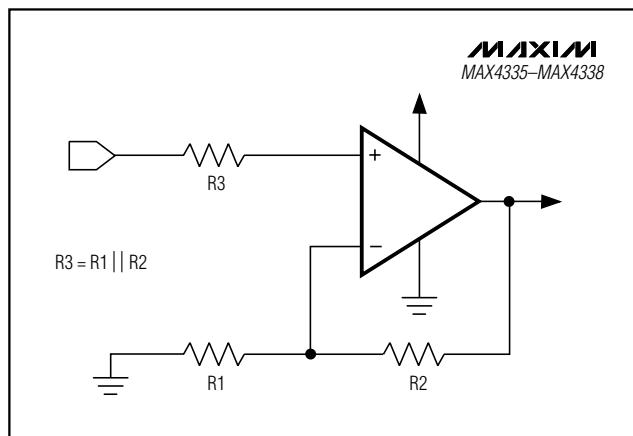

Figure 3. Reducing Offset Error Due to Bias Current (Noninverting)

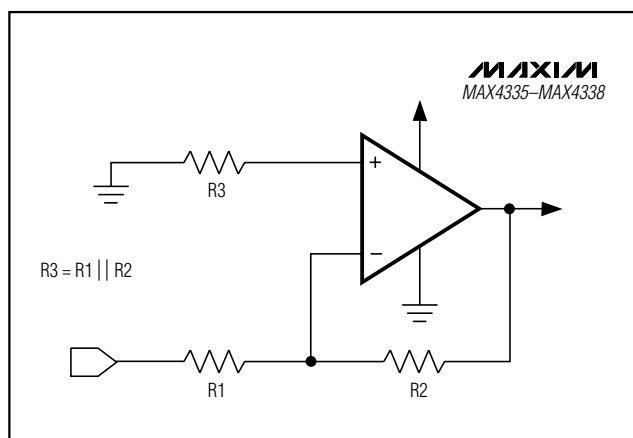

Figure 4. Reducing Offset Error Due to Bias Current (Inverting)

Rail-to-Rail Output Stage

The minimum output is within millivolts of ground for single-supply operation, where the load is referenced to ground (GND). Figure 6 shows the input voltage range and the output voltage swing of a MAX4335 connected as a voltage follower. The maximum output voltage swing is load dependent; however, it is guaranteed to be within 400mV of the positive rail ($V_{CC} = 2.7V$) even with maximum load (32Ω to $V_{CC}/2$).

Driving Capacitive Loads

The MAX4335–MAX4338 have a high tolerance for capacitive loads. They are stable with capacitive loads up to 200pF. Figure 7 is a graph of the stable operating region for various capacitive loads vs. resistive loads.

SC70/SOT23-8, 50mA I_{OUT}, Rail-to-Rail I/O Op Amps with Shutdown/Mute

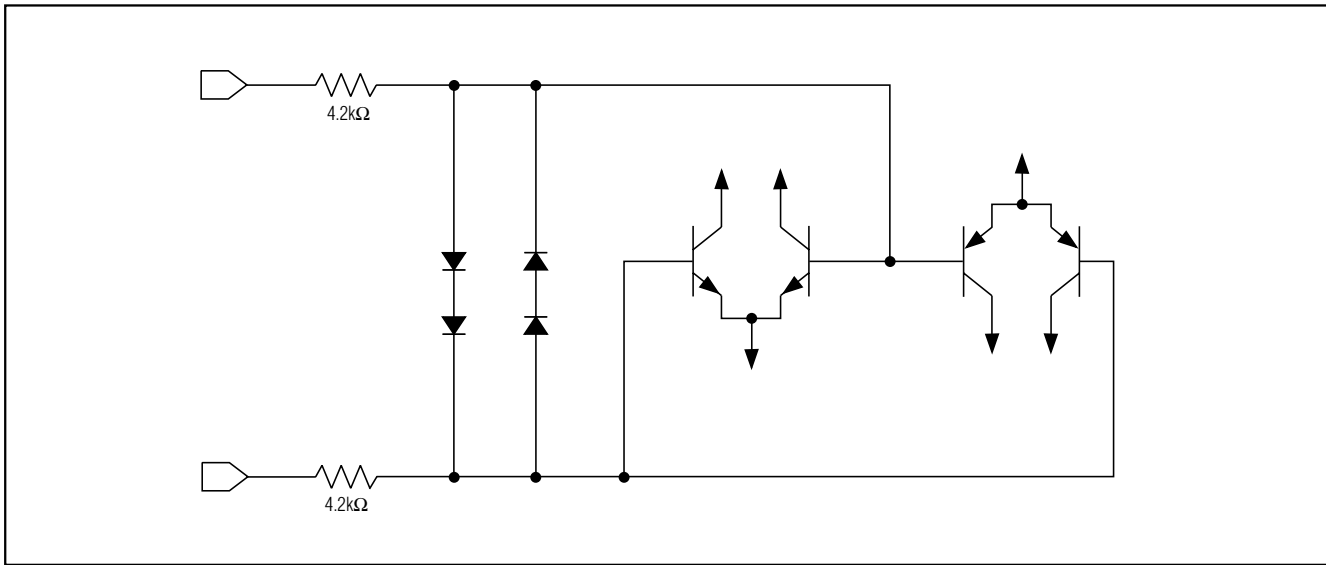

Figure 5. Input Protection Circuit

Figures 8 and 9 show the transient response with excessive capacitive loads (330pF), with and without the addition of an isolation resistor in series with the output. Figure 10 shows a typical noninverting capacitive-load-driving circuit in the unity-gain configuration. The resistor improves the circuit's phase margin by isolating the load capacitor from the op amp's output.

Power-Up and Shutdown/Mute Modes

The MAX4336/MAX4338 have a shutdown option. When the shutdown pin ($\overline{\text{SHDN}}$) is pulled low, supply current drops to 0.04 μA per amplifier ($V_{\text{CC}} = 5\text{V}$), the amplifiers are disabled, and their outputs are placed in a high-impedance state. Pulling $\overline{\text{SHDN}}$ high enables the amplifier. In the dual MAX4338, the two amplifiers shut down independently. Figure 11 shows the MAX4336's output voltage response to a shutdown pulse. The MAX4335-MAX4338 typically settle within 5 μs after power-up (Figure 12).

Power Supplies and Layout

The MAX4335-MAX4338 can operate from a single 2.7V to 5.5V supply. Bypass the power supply with a 0.1 μF ceramic capacitor in parallel with at least 1 μF . Good layout improves performance by decreasing the amount of stray capacitance at the op amps' inputs and outputs. Decrease stray capacitance by placing external components close to the op amps' input/output pins, minimizing trace and lead lengths.

Thermal Overload Protection

The MAX4335-MAX4338 includes thermal overload protection circuitry. When the junction temperature of the device exceeds +140°C, the supply current drops to 120 μA per amplifier ($V_{\text{CC}} = 5\text{V}$) and the outputs are placed in a high-impedance state. The device returns to normal operation when the junction temperature falls to below +120°C.

Short-Circuit Current Protection

The MAX4335-MAX4338 incorporate a smart short-circuit protection feature. Figure 7 shows the output voltage region where the protection circuitry is active. A fault condition occurs when $I_{\text{OUT}} > 110\text{mA}$ and $V_{\text{OUT}} > 1\text{V}$ (sinking current) or when $I_{\text{OUT}} > 110\text{mA}$ and $(V_{\text{CC}} - V_{\text{OUT}}) > 1\text{V}$ (sourcing current). When a fault is detected, the short-circuit protection circuitry is activated and the output current is limited to 110mA, protecting the device and the application circuitry. When the smart short circuit is not active, the output current can safely exceed 110mA (see the Output Current vs. Output Voltage Graph in the *Typical Operating Characteristics*).

SC70/SOT23-8, 50mA I_{OUT}, Rail-to-Rail I/O Op Amps with Shutdown/Mute

MAX4335-MAX4338

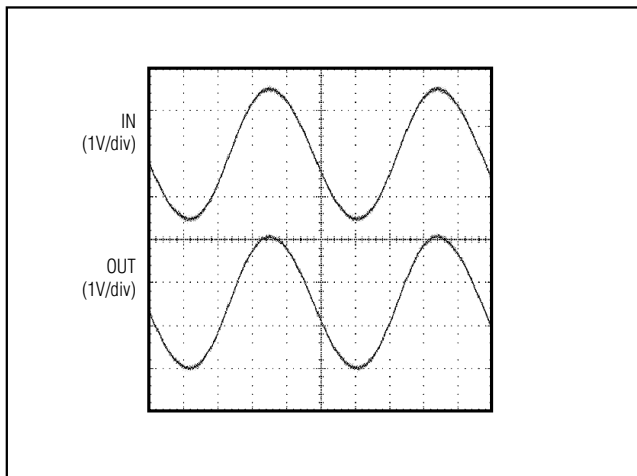

Figure 6. Rail-to-Rail Input/Output Range

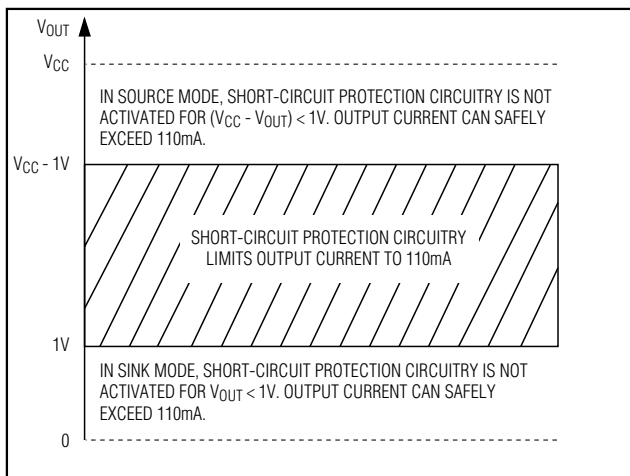

Figure 7. Short-Circuit Protection

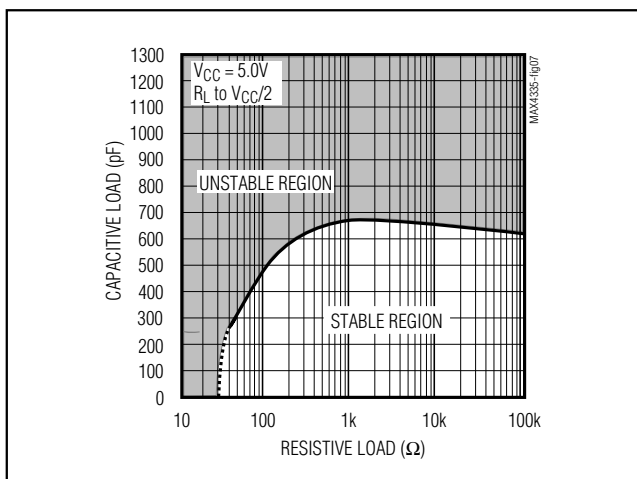

Figure 8. Capacitive-Load Stability

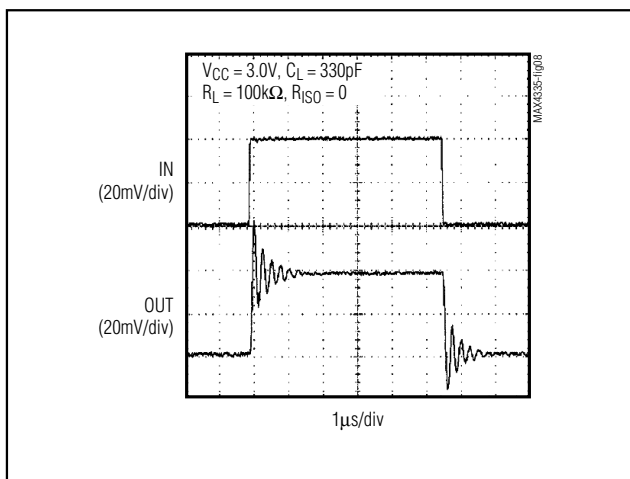

Figure 9. Small-Signal Transient Response with Excessive Capacitive Load

SC70/SOT23-8, 50mA I_{OUT}, Rail-to-Rail I/O Op Amps with Shutdown/Mute

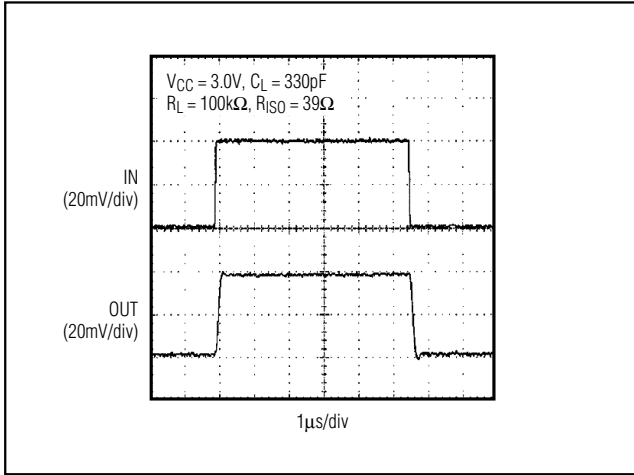

Figure 10. Small-Signal Transient Response with Excessive Capacitive Load with Isolation Resistor

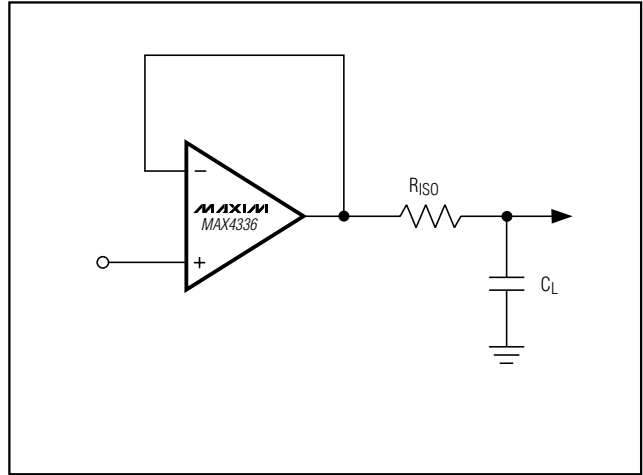

Figure 11. Capacitive-Load-Driving Circuit

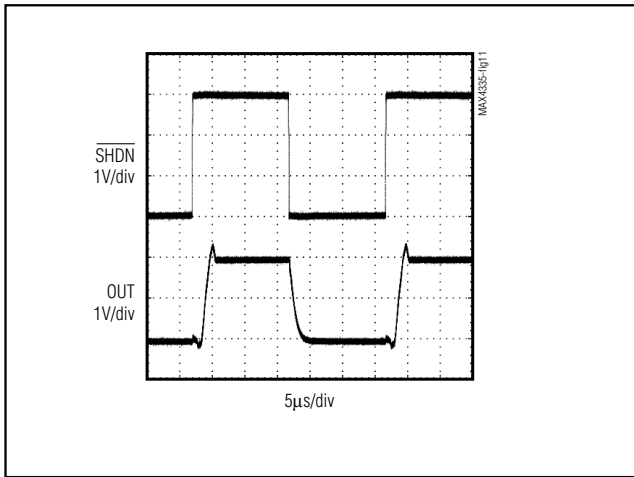

Figure 12. Shutdown Output Voltage Enable/Disable

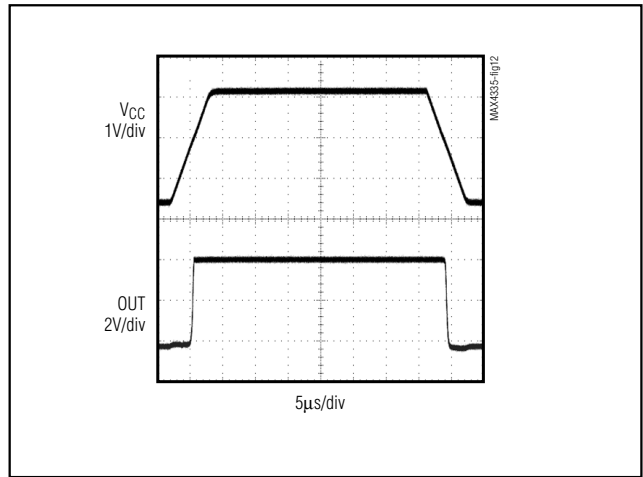
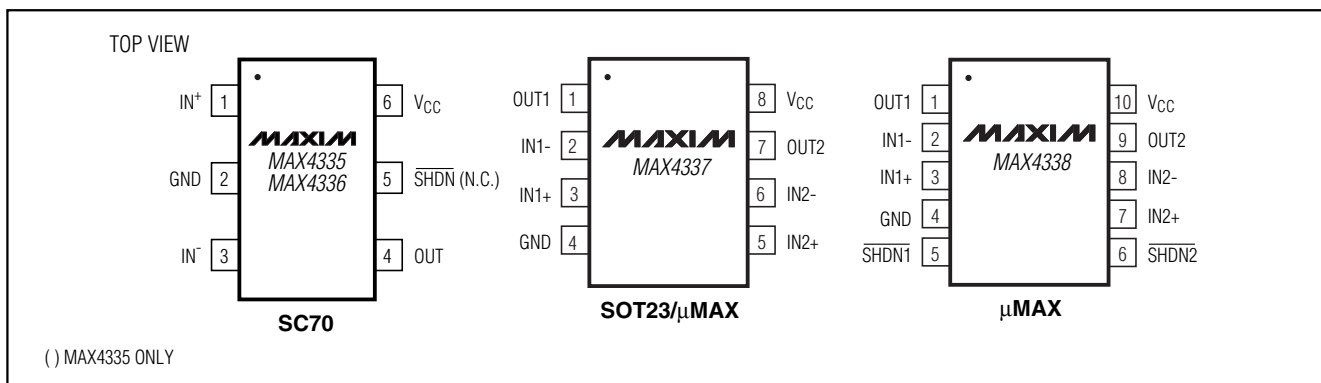

Figure 13. Power-Up/Down Output Voltage

SC70/SOT23-8, 50mA I_{OUT}, Rail-to-Rail I/O Op Amps with Shutdown/Mute

Pin Configurations



Chip Information

MAX4335 TRANSISTOR COUNT: 1200
 MAX4336 TRANSISTOR COUNT: 1200
 MAX4337 TRANSISTOR COUNT: 2400
 MAX4338 TRANSISTOR COUNT: 2400
 PROCESS: BiCMOS

MAX4335-MAX4338

SC70/SOT23-8, 50mA IOUT, Rail-to-Rail I/O Op Amps with Shutdown/Mute

Package Information

(The package drawing(s) in this data sheet may not reflect the most current specifications. For the latest package outline information, go to www.maxim-ic.com/packages.)

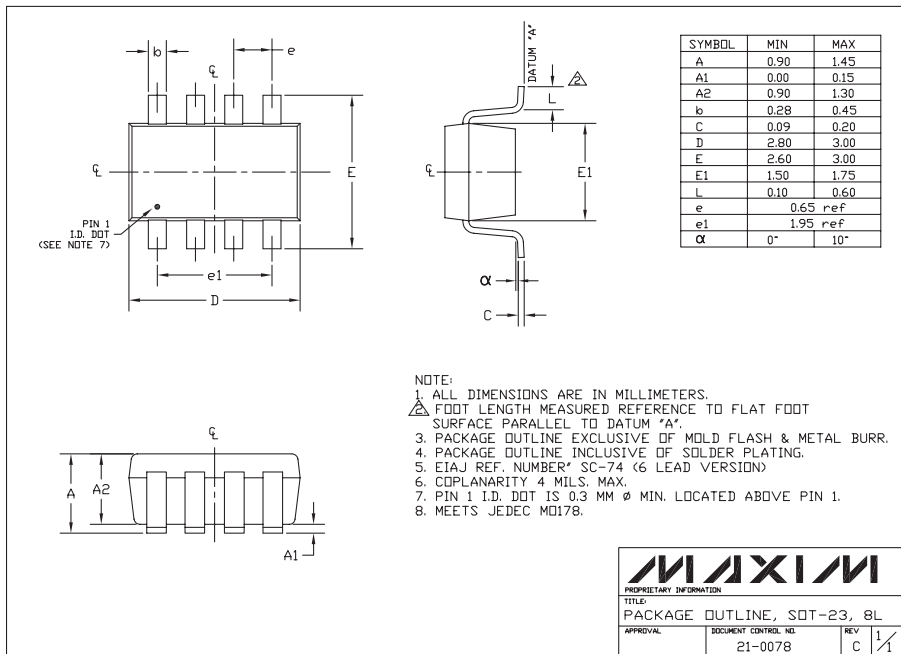
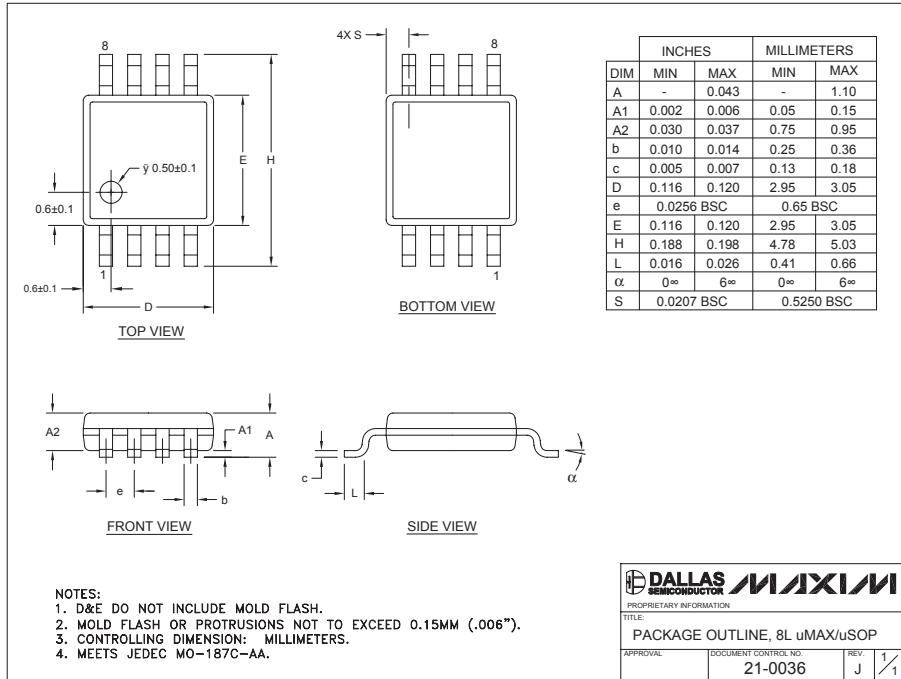

SC70/SOT23-8, 50mA IOOUT, Rail-to-Rail I/O Op Amps with Shutdown/Mute

Package Information (continued)

(The package drawing(s) in this data sheet may not reflect the most current specifications. For the latest package outline information, go to www.maxim-ic.com/packages.)

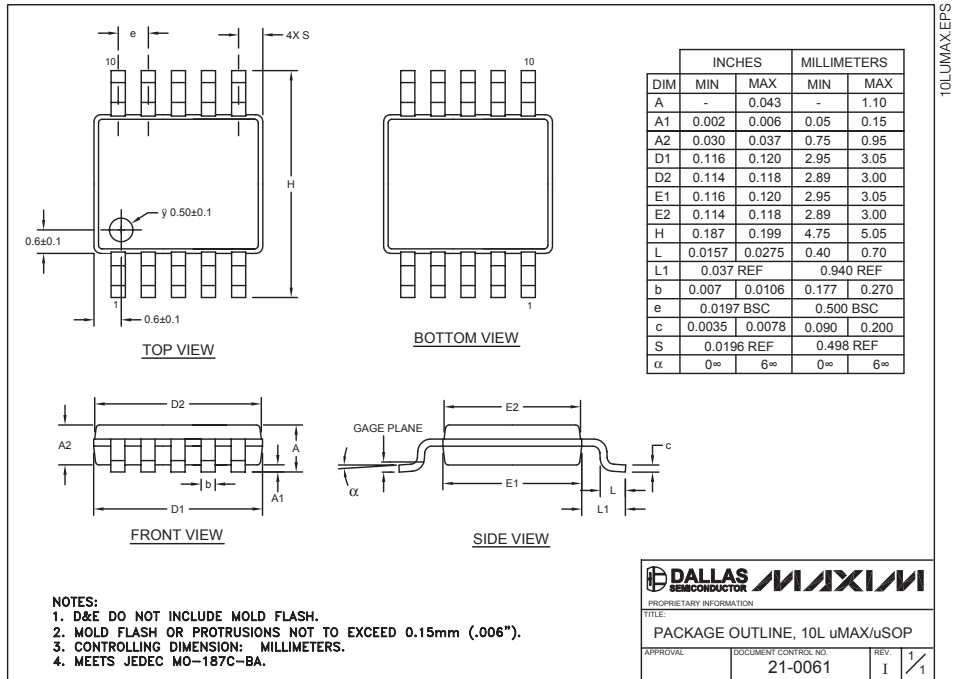

MAX4335-MAX4338

Maxim cannot assume responsibility for use of any circuitry other than circuitry entirely embodied in a Maxim product. No circuit patent licenses are implied. Maxim reserves the right to change the circuitry and specifications without notice at any time.

Maxim Integrated Products, 120 San Gabriel Drive, Sunnyvale, CA 94086 408-737-7600 17