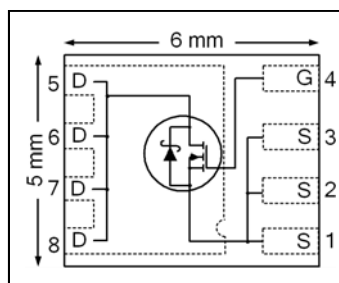


HEXFET® Power MOSFET

$V_{DSS}$	25	V
$R_{DS(on) \max}$ (@ $V_{GS} = 10V$ )	1.10	mΩ
(@ $V_{GS} = 4.5V$ )	1.35	
$Qg$ (typical)	37.0	nC
$I_D$ (@ $T_C(Bottom) = 25^\circ C$ )	100 <sup>Ⓣ</sup>	A



### Applications

- Synchronous Rectifier MOSFET for Synchronous Buck Converters

### Features

Low $R_{DS(ON)}$ (<1.10 mΩ)
Schottky Intrinsic Diode with Low Forward Voltage
Low Thermal Resistance to PCB (<1.0°C/W)
Low Profile (<0.9 mm)
Industry-Standard Pinout
Compatible with Existing Surface Mount Techniques
RoHS Compliant, Halogen-Free
MSL1, Industrial Qualification

results in  
⇒

### Benefits

Lower Conduction Losses
Lower Switching Losses
Enable better thermal dissipation
Increased Power Density
Multi-Vendor Compatibility
Easier Manufacturing
Environmentally Friendlier
Increased Reliability

Base part number	Package Type	Standard Pack		Orderable Part Number
		Form	Quantity	
IRFH4210DPbF	PQFN 5mm x 6 mm	Tape and Reel	4000	IRFH4210DTRPbF

### Absolute Maximum Ratings

	Parameter	Max.	Units
$V_{GS}$	Gate-to-Source Voltage	± 20	V
$I_D @ T_A = 25^\circ C$	Continuous Drain Current, $V_{GS} @ 10V$	44	A
$I_D @ T_{C(Bottom)} = 25^\circ C$	Continuous Drain Current, $V_{GS} @ 10V$	266 <sup>Ⓣ</sup>	
$I_D @ T_{C(Bottom)} = 100^\circ C$	Continuous Drain Current, $V_{GS} @ 10V$	168 <sup>Ⓣ</sup>	
$I_D @ T_{C(Bottom)} = 25^\circ C$	Continuous Drain Current, $V_{GS} @ 10V$ (Source Bonding Technology Limited)	100 <sup>Ⓣ</sup>	
$I_{DM}$	Pulsed Drain Current <sup>①</sup>	400	
$P_D @ T_A = 25^\circ C$	Power Dissipation <sup>⑤</sup>	3.5	W
$P_D @ T_{C(Bottom)} = 25^\circ C$	Power Dissipation	125	
	Linear Derating Factor	0.028	W/°C
$T_J$ $T_{STG}$	Operating Junction and Storage Temperature Range	-55 to + 150	°C

Notes <sup>①</sup> through <sup>⑦</sup> are on page 8

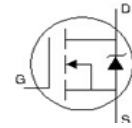
**Static @ T<sub>J</sub> = 25°C (unless otherwise specified)**

	Parameter	Min.	Typ.	Max.	Units	Conditions
BV <sub>DSS</sub>	Drain-to-Source Breakdown Voltage	25	—	—	V	V <sub>GS</sub> = 0V, I <sub>D</sub> = 1mA
ΔBV <sub>DSS</sub> /ΔT <sub>J</sub>	Breakdown Voltage Temp. Coefficient	—	19	—	mV/°C	Reference to 25°C, I <sub>D</sub> = 10mA
R <sub>DS(on)</sub>	Static Drain-to-Source On-Resistance	—	0.85	1.10	mΩ	V <sub>GS</sub> = 10V, I <sub>D</sub> = 50A ③
		—	1.10	1.35		V <sub>GS</sub> = 4.5V, I <sub>D</sub> = 50A ③
V <sub>GS(th)</sub>	Gate Threshold Voltage	1.1	1.6	2.1	V	V <sub>DS</sub> = V <sub>GS</sub> , I <sub>D</sub> = 100μA
ΔV <sub>GS(th)</sub>	Gate Threshold Voltage Coefficient	—	-10	—	mV/°C	
I <sub>DSS</sub>	Drain-to-Source Leakage Current	—	—	250	μA	V <sub>DS</sub> = 20V, V <sub>GS</sub> = 0V
I <sub>GSS</sub>	Gate-to-Source Forward Leakage	—	—	100	nA	V <sub>GS</sub> = 20V
	Gate-to-Source Reverse Leakage	—	—	-100		V <sub>GS</sub> = -20V
g <sub>fs</sub>	Forward Transconductance	392	—	—	S	V <sub>DS</sub> = 13V, I <sub>D</sub> = 50A
Q <sub>g</sub>	Total Gate Charge	—	77.0	—	nC	V <sub>GS</sub> = 10V, V <sub>DS</sub> = 13V, I <sub>D</sub> = 50A
Q <sub>g</sub>	Total Gate Charge	—	37.0	55.5	nC	V <sub>DS</sub> = 13V V <sub>GS</sub> = 4.5V I <sub>D</sub> = 50A
Q <sub>gs1</sub>	Pre-V <sub>th</sub> Gate-to-Source Charge	—	7.6	—		
Q <sub>gs2</sub>	Post-V <sub>th</sub> Gate-to-Source Charge	—	6.4	—		
Q <sub>gd</sub>	Gate-to-Drain Charge	—	13.2	—		
Q <sub>godr</sub>	Gate Charge Overdrive	—	9.8	—		
Q <sub>sw</sub>	Switch Charge (Q <sub>gs2</sub> + Q <sub>gd</sub> )	—	19.6	—		
Q <sub>oss</sub>	Output Charge	—	37	—	nC	V <sub>DS</sub> = 16V, V <sub>GS</sub> = 0V
R <sub>G</sub>	Gate Resistance	—	1.3	—	Ω	
t <sub>d(on)</sub>	Turn-On Delay Time	—	19	—	ns	V <sub>DD</sub> = 13V, V <sub>GS</sub> = 4.5V I <sub>D</sub> = 50A R <sub>G</sub> = 1.8Ω
t <sub>r</sub>	Rise Time	—	45	—		
t <sub>d(off)</sub>	Turn-Off Delay Time	—	24	—		
t <sub>f</sub>	Fall Time	—	16	—		
C <sub>iss</sub>	Input Capacitance	—	4812	—	pF	V <sub>GS</sub> = 0V V <sub>DS</sub> = 13V f = 1.0MHz
C <sub>oss</sub>	Output Capacitance	—	1459	—		
C <sub>rss</sub>	Reverse Transfer Capacitance	—	355	—		

**Avalanche Characteristics**

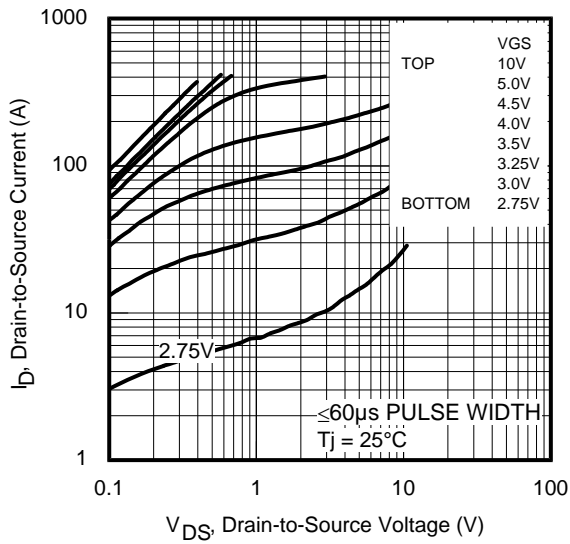
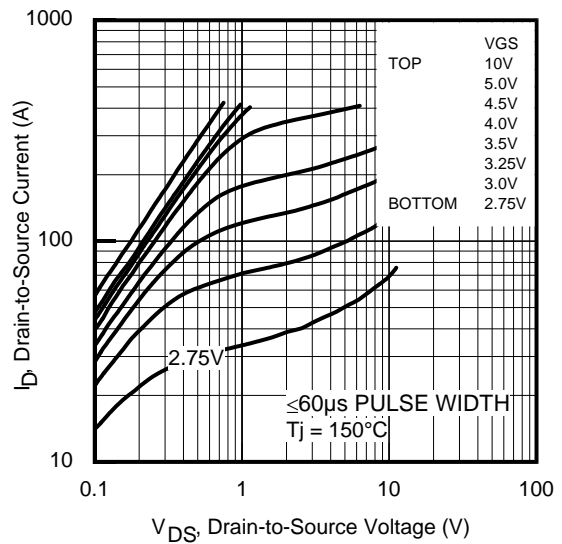
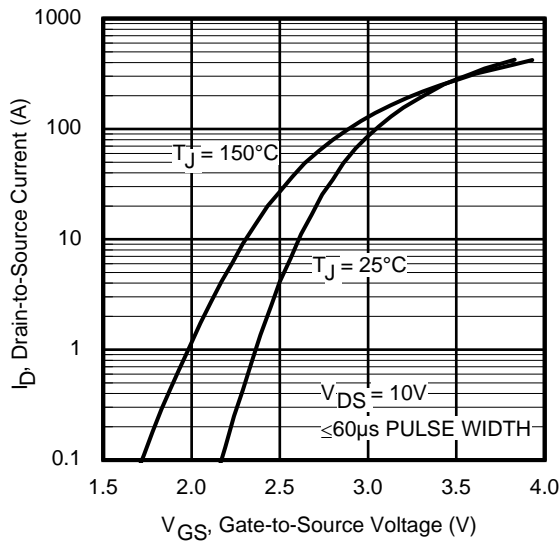
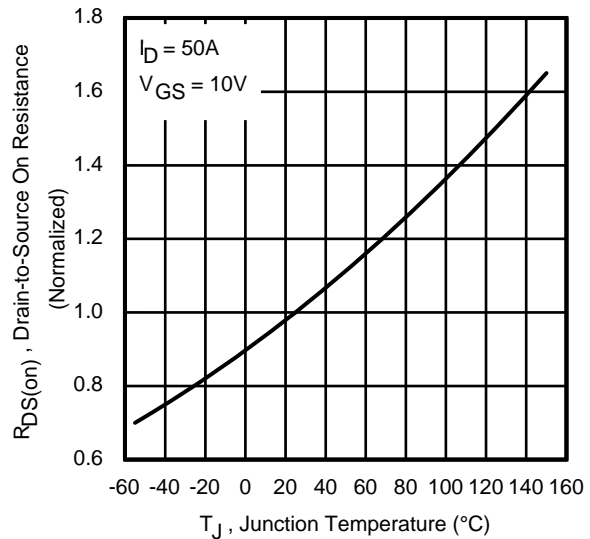
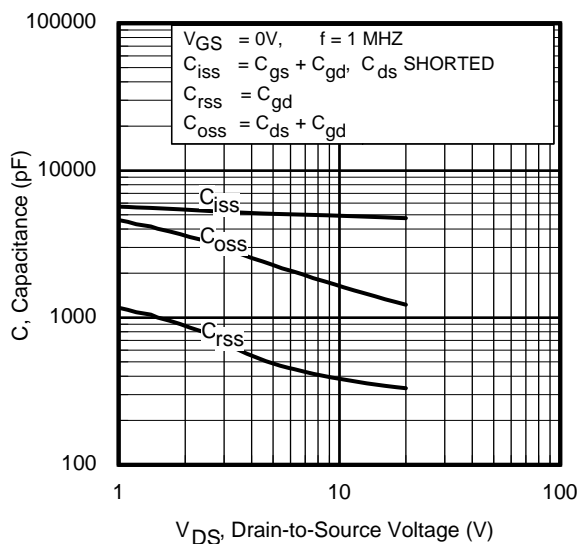
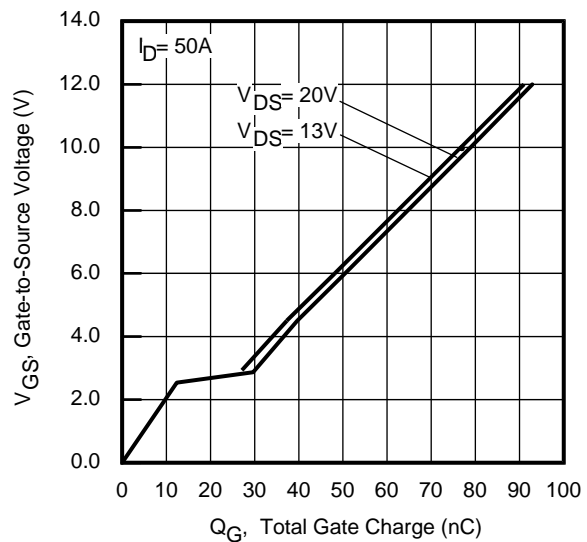
	Parameter	Typ.	Max.
E <sub>AS</sub>	Single Pulse Avalanche Energy ②	—	247
I <sub>AR</sub>	Avalanche Current ①	—	50

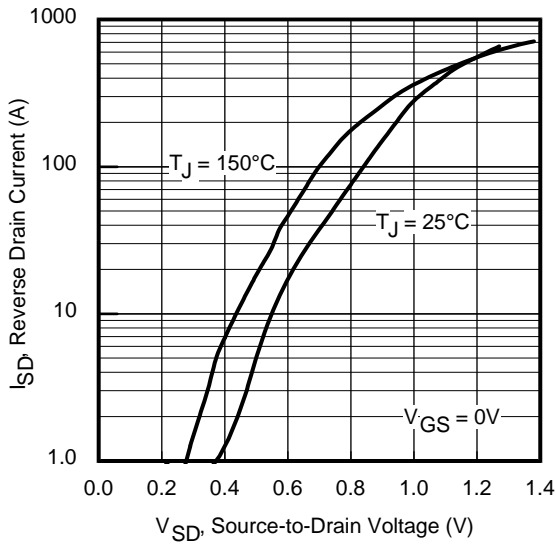
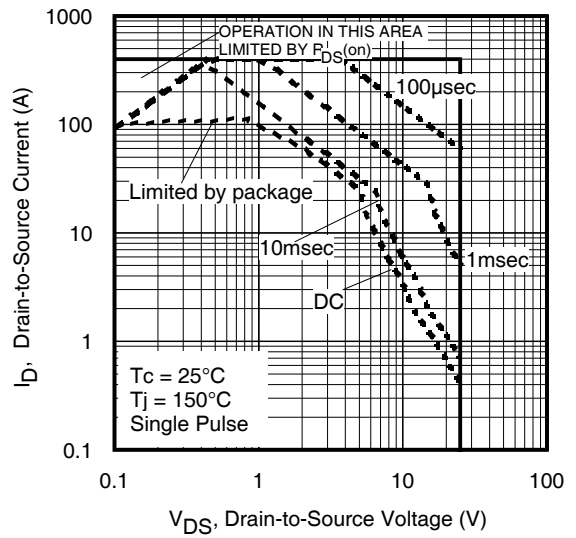
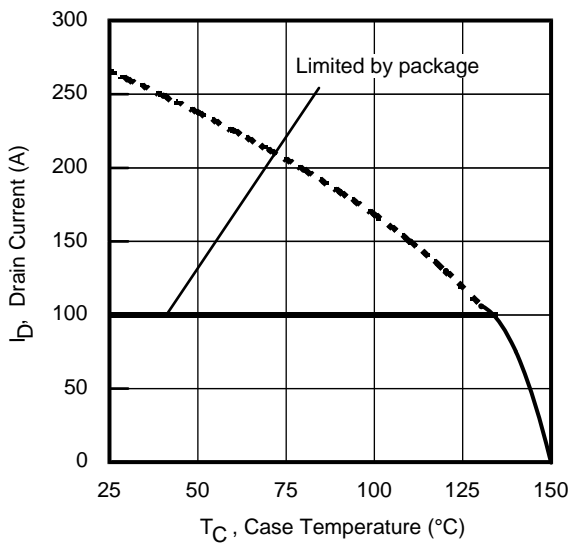
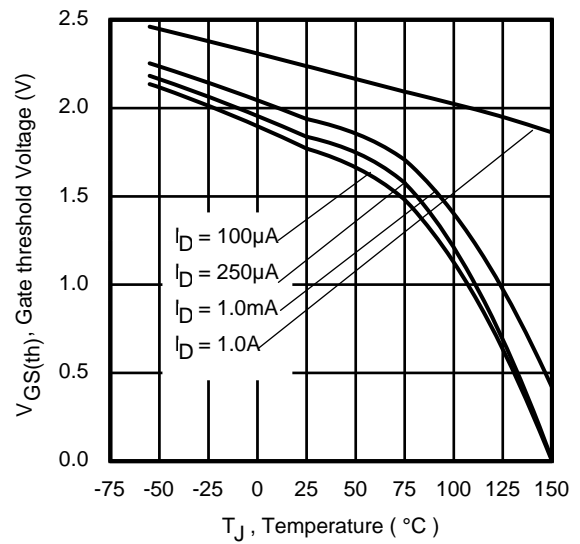
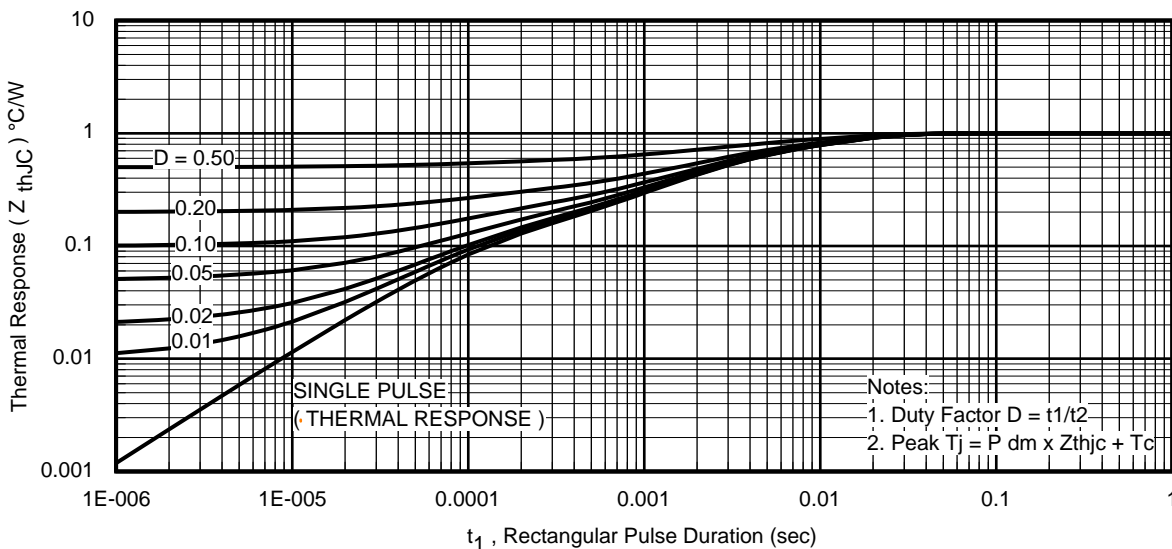
**Diode Characteristics**

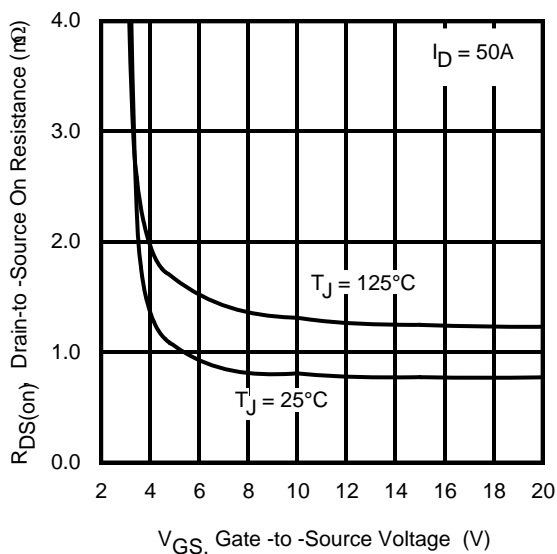
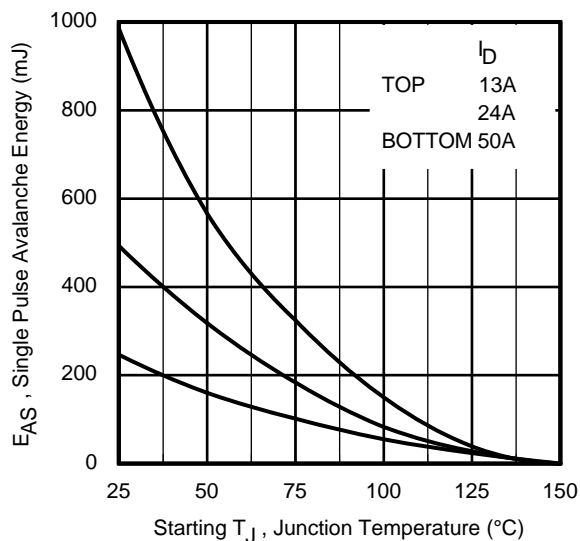
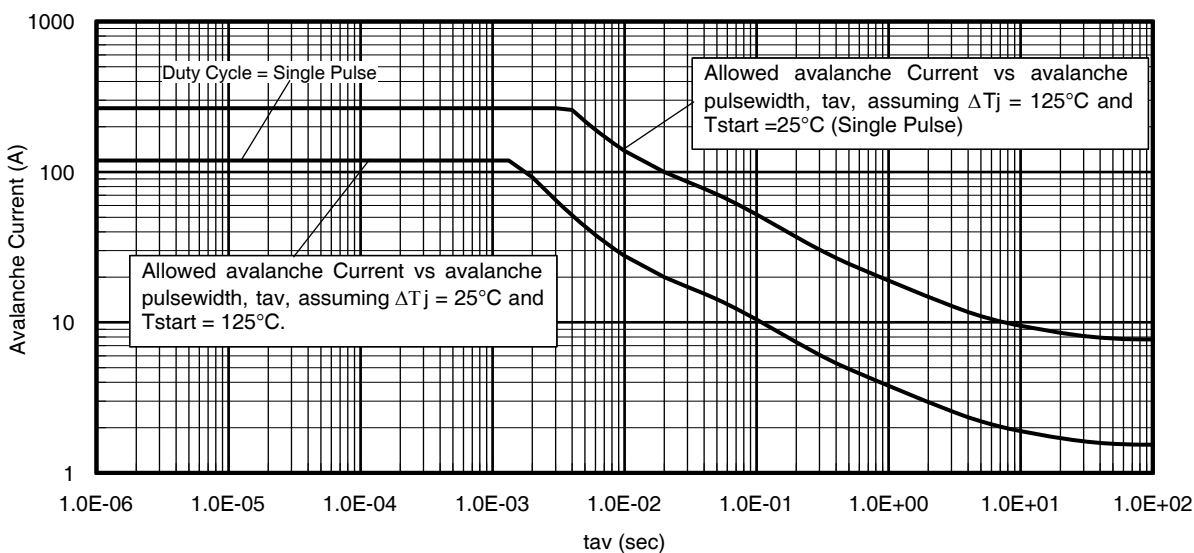
	Parameter	Min.	Typ.	Max.	Units	Conditions
I <sub>S</sub>	Continuous Source Current (Body Diode)	—	—	100 <sup>⑦</sup>	A	MOSFET symbol showing the integral reverse p-n junction diode. 
I <sub>SM</sub>	Pulsed Source Current (Body Diode) ①	—	—	400		
V <sub>SD</sub>	Diode Forward Voltage	—	—	0.75	V	T <sub>J</sub> = 25°C, I <sub>S</sub> = 50A, V <sub>GS</sub> = 0V ③
t <sub>rr</sub>	Reverse Recovery Time	—	27	41	ns	T <sub>J</sub> = 25°C, I <sub>F</sub> = 50A, V <sub>DD</sub> = 13V
Q <sub>rr</sub>	Reverse Recovery Charge	—	59	89	nC	di/dt = 300A/μs ③

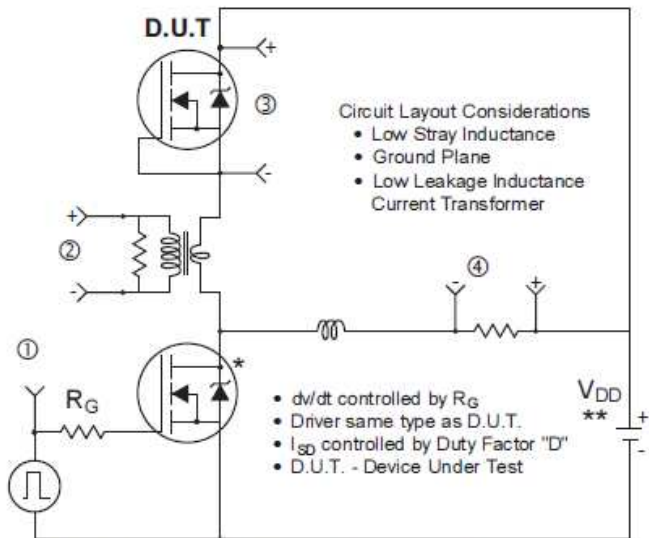
**Thermal Resistance**

	Parameter	Typ.	Max.	Units
R <sub>θJC</sub> (Bottom)	Junction-to-Case ④	—	1.0	°C/W
R <sub>θJC</sub> (Top)	Junction-to-Case ④	—	22	
R <sub>θJA</sub>	Junction-to-Ambient ⑤	—	36	
R <sub>θJA</sub> (<10s)	Junction-to-Ambient ⑤	—	21	

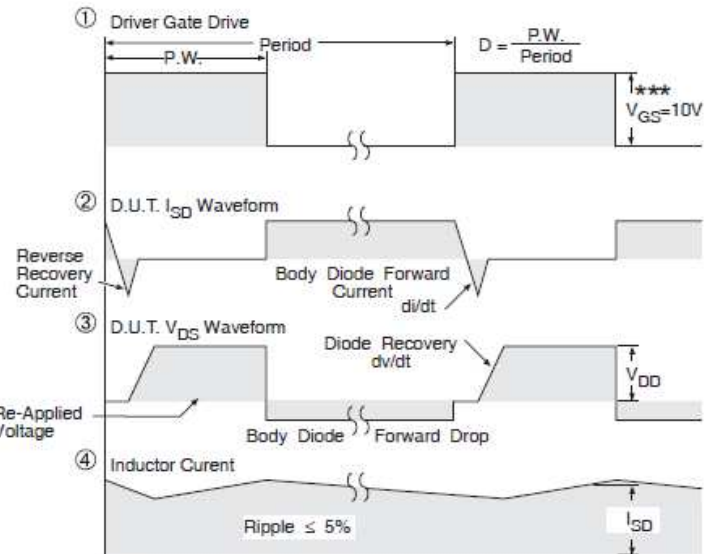

**Fig 1.** Typical Output Characteristics

**Fig 2.** Typical Output Characteristics

**Fig 3.** Typical Transfer Characteristics

**Fig 4.** Normalized On-Resistance vs. Temperature

**Fig 5.** Typical Capacitance vs. Drain-to-Source Voltage

**Fig 6.** Typical Gate Charge vs. Gate-to-Source Voltage


**Fig 7.** Typical Source-Drain Diode Forward Voltage

**Fig 8.** Maximum Safe Operating Area

**Fig 9.** Maximum Drain Current vs. Case Temperature

**Fig 10.** Drain-to-Source Breakdown Voltage

**Fig 11.** Maximum Effective Transient Thermal Impedance, Junction-to-Case

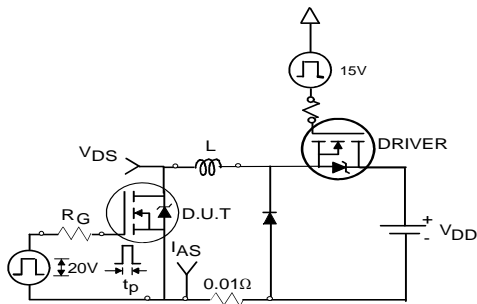
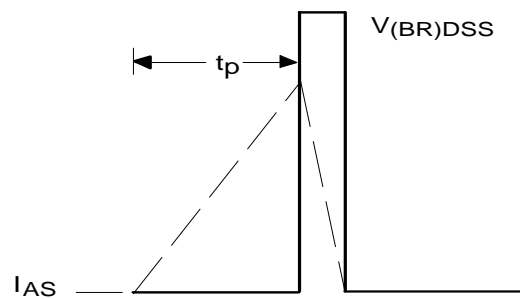
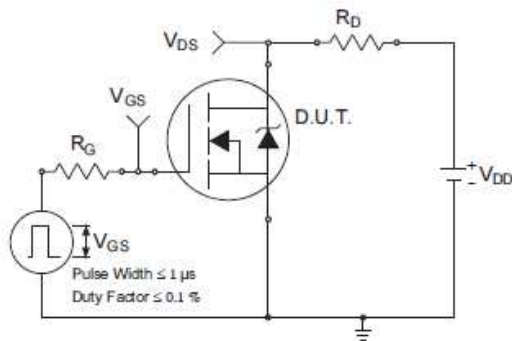
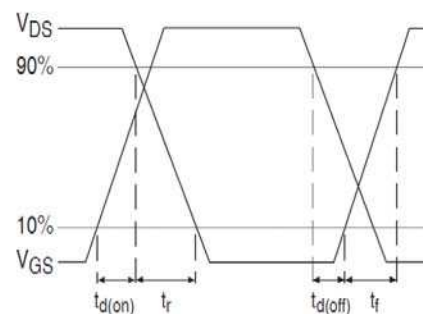
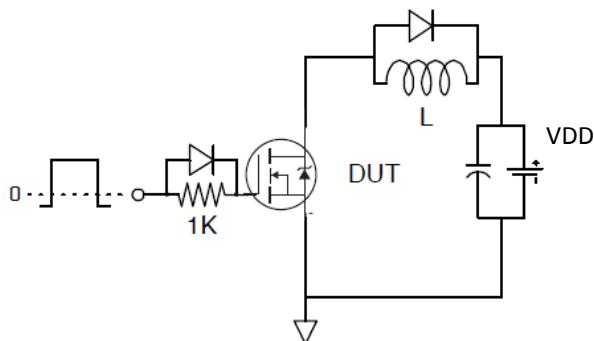
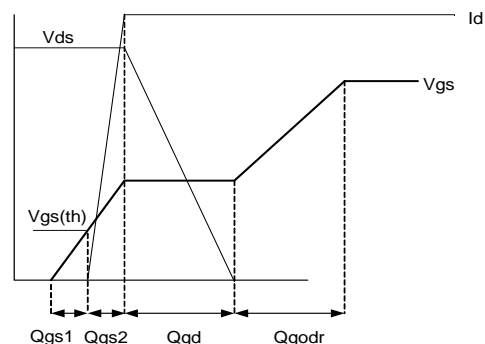

**Fig 12.** On-Resistance vs. Gate Voltage

**Fig 13.** Maximum Avalanche Energy vs. Drain Current

**Fig 14.** Typical Avalanche Current vs. Pulsewidth

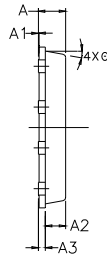


\* Use P-Channel Driver for P-Channel Measurements  
 \*\* Reverse Polarity for P-Channel

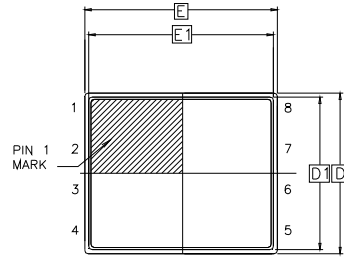
**Fig 15. Peak Diode Recovery dv/dt Test Circuit for N-Channel HEXFET® Power MOSFETs**


\*\*\*  $V_{GS} = 5V$  for Logic Level Devices


**Fig 16a. Unclamped Inductive Test Circuit**

**Fig 16b. Unclamped Inductive Waveforms**

**Fig 17a. Switching Time Test Circuit**

**Fig 17b. Switching Time Waveforms**

**Fig 18. Gate Charge Test Circuit**

**Fig 19. Gate Charge Waveform**

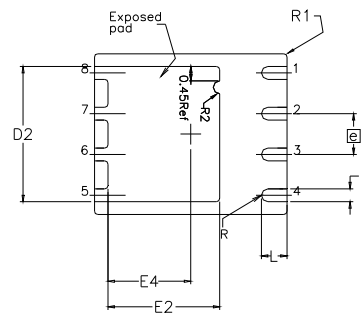
**PQFN 5x6 Outline "B" Package Details**


SIDE VIEW



TOP VIEW

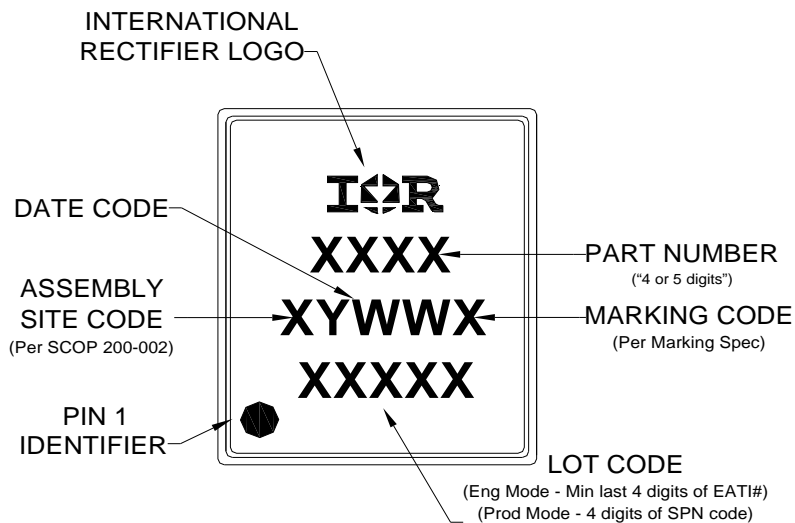
DIM SYMBOL	MIN	NOM	MAX
A	0.800	0.830	1.05
A1	0.000	0.020	0.050
A2	0.580	0.630	0.680
A3		0.254 REF	
Ø	0"	10"	12"
b	0.350	0.400	0.470
D	4.850	5.000	5.150
D1	4.675	4.750	5.000
D2	3.700	4.210	4.300
e		1.270 BSC	
E	5.850	6.000	6.150
E1	5.675	5.750	6.000
E2	3.380	3.480	3.760
E4	2.480	2.580	2.680
L	0.550	0.800	0.900
R		0.200 REF	
R1		0.100 REF	
R2	0.150	0.200	0.250



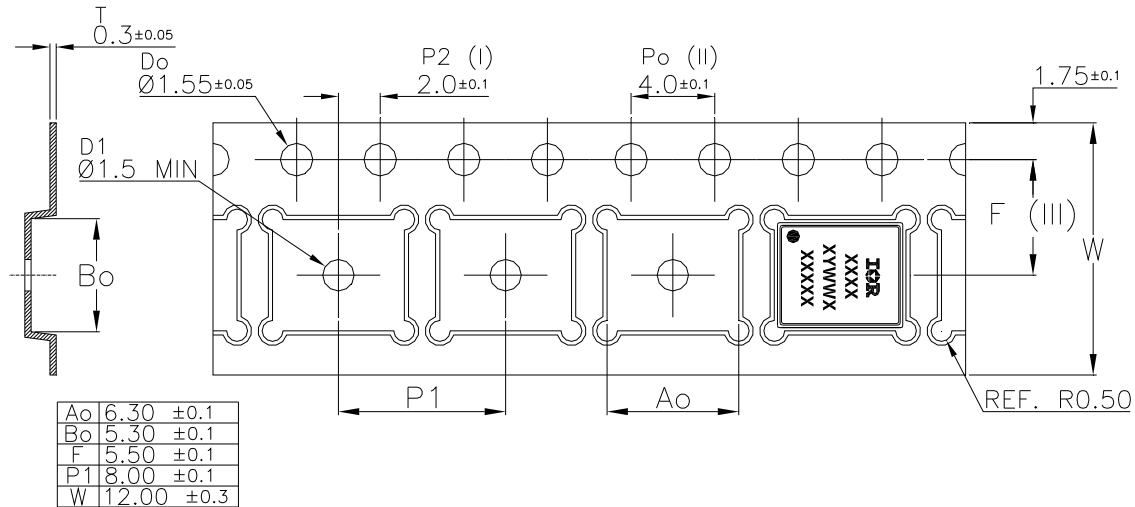
BOTTOM VIEW

For more information on board mounting, including footprint and stencil recommendation, please refer to application note AN-1136: <http://www.irf.com/technical-info/appnotes/an-1136.pdf>

For more information on package inspection techniques, please refer to application note AN-1154: <http://www.irf.com/technical-info/appnotes/an-1154.pdf>

**PQFN 5x6 Outline "B" Part Marking**


Note: For the most current drawing please refer to IR website at <http://www.irf.com/package/>

**PQFN 5x6 Outline "B" Tape and Reel**


Note: For the most current drawing please refer to IR website at <http://www.irf.com/package/>

**Qualification Information†**

<b>Qualification Level</b>	Industrial (per JEDEC JESD47F†† guidelines)	
<b>Moisture Sensitivity Level</b>	PQFN 5mm x 6mm	MSL1 (per JEDEC J-STD-020D††)
<b>RoHS Compliant</b>	Yes	

† Qualification standards can be found at International Rectifier's web site: <http://www.irf.com/product-info/reliability>

†† Applicable version of JEDEC standard at the time of product release.

**Notes:**

- ① Repetitive rating; pulse width limited by max. junction temperature.
- ② Starting  $T_J = 25^\circ\text{C}$ ,  $L = 0.20\text{mH}$ ,  $R_G = 50\Omega$ ,  $I_{AS} = 50\text{A}$ .
- ③ Pulse width  $\leq 400 \mu\text{s}$ ; duty cycle  $\leq 2\%$ .
- ④  $R_\theta$  is measured at  $T_J$  of approximately  $90^\circ\text{C}$ .
- ⑤ When mounted on 1 inch square PCB (FR-4). Please refer to AN-994 for more details:  
<http://www.irf.com/technical-info/appnotes/an-994.pdf>
- ⑥ Calculated continuous current based on maximum allowable junction temperature.
- ⑦ Current is limited to 100A by source bonding technology.

**Revision History**

Date	Comments
04/30/2013	• Release of final data sheet.
05/17/2013	• Updated package 3D drawing, on page 1. • Added Continuous Drain Current limited by source bonding technology, on page 1. • Divided note 6 into note 6 & 7, on page 8.
08/14/2013	• Added "Fast/RFET™" above the part number, on page 1.

International  
 Rectifier

**IR WORLD HEADQUARTERS:** 101 N. Sepulveda Blvd., El Segundo, California 90245, USA

To contact International Rectifier, please visit <http://www.irf.com/whoto-call/>