

12.5-30GHz Low Noise Amplifier

GaAs Monolithic Microwave IC

Description

The CHA3689-99F is a three-stage self biased wide band monolithic low noise amplifier.

It is designed for a wide range of applications, from military to commercial communication systems.

The circuit is manufactured with a pHEMT process, 0.25 μ m gate length, via holes through the substrate, air bridges and electron beam gate lithography.

It is available in chip form.

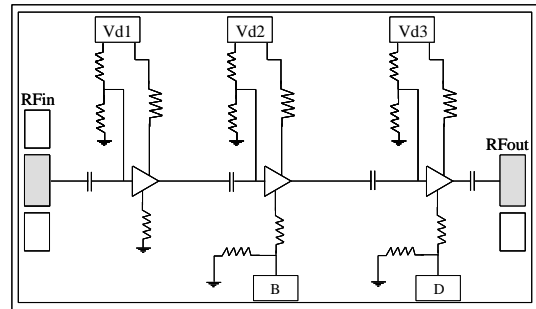

Main Features

- Broadband performance: 12.5-30GHz
- 2.0dB noise figure
- 26dB gain (12.5-26GHz)
- 26dBm output IP3 (18-30GHz)
- Low DC power consumption
- DC bias: Vd=4 Volt @ Id= 90 /120mA
- Chip size : 2.45 x 1.21 x 0.1mm

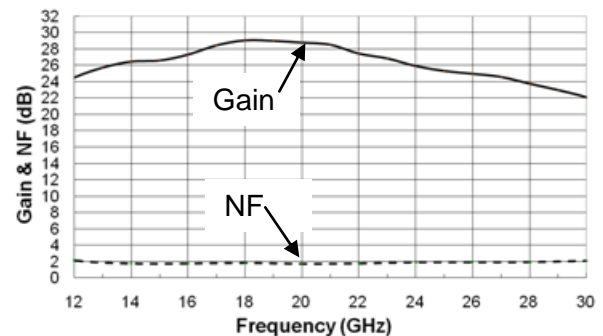

On wafer typical measurements @ 120mA

Main Characteristics

Tamb = +25°C, Vd1=Vd2=Vd3 = +4V Pads B, D = GND (High current configuration)

Symbol	Parameter	Min	Typ	Max	Unit
Freq	Frequency range	12.5		30	GHz
Gain	Linear Gain		26		dB
NF	Noise Figure		2	2.6	dB
Pout1dB	Output Power @1dB comp.	14	15		dBm

Main Characteristics (low current configuration)

Tamb = +25°C, Vd1=Vd2=Vd3= +4V Pads B, D = not connected

Symbol	Parameter	Min	Typ	Max	Unit
Freq	Frequency range	12.5		30	GHz
Gain	Gain (12.5 - 24GHz)	23	26		dB
	Gain (24.5 - 30GHz)	20	22		dB
ΔG	Gain flatness (12.5 - 24GHz)		±2.5		dB
	Gain flatness (24.5 - 30GHz)		±2		dB
NF	Noise figure (12.5 - 24GHz)		1.8	2.3	dB
	Noise figure (24.5 - 30GHz)		2.0	2.5	dB
S11	Input return loss (12.5 - 16GHz) (27 - 30GHz)		3.0:1	3.5:1	dB
	Input return loss (16 - 27GHz)		2.0:1	2.5:1	dB
S22	Output return loss		2.5:1	3.0:1	dB
OIP3	3rd order intercept point (18 – 30GHz)	23	24		dBm
P1dB	Output power at 1dB gain compression	13	14		dBm
Id	Drain bias current		90	120	mA
Vd	Drain bias voltage		4		V

These values are representative of on-wafer measurements that are made without bonding wires at the RF ports.

Main Characteristics (high current configuration)

Tamb = +25°C, Vd1=Vd2=Vd3= +4V Pads B, D = GND

Symbol	Parameter	Min	Typ	Max	Unit
Freq	Frequency range	12.5		30	GHz
Gain	Gain (12.5 - 24GHz)	24	27		dB
	Gain (24.5 - 30GHz)	21	23		dB
ΔG	Gain flatness (12.5 - 24GHz)		±2.5		dB
	Gain flatness (24.5 - 30GHz)		±2		dB
NF	Noise figure (12.5 - 24GHz)		1.9	2.4	dB
	Noise figure (24.5 - 30GHz)		2.1	2.6	dB
S11	Input return loss (12.5 - 16GHz) (27 - 30GHz)		3.0:1	3.5:1	dB
	Input return loss (16 - 27GHz)		2.0:1	2.5:1	dB
S22	Output return loss		2.5:1	3.0:1	dB
OIP3	3rd order intercept point (18 – 30GHz)	25	26		dBm
P1dB	Output power at 1dB gain compression	14	15		dBm
Id	Drain bias current		120	150	mA
Vd	Drain bias voltage		4		V

These values are representative of on-wafer measurements that are made without bonding wires at the RF ports.

Absolute Maximum Ratings ⁽¹⁾

Tamb.= +25°C

Symbol	Parameter	Values	Unit
Vd	Drain bias voltage	4.5V	V
Pin	RF input power	+10	dBm
Tj	Junction temperature	175	°C
Ta	Operating temperature range	-40 to +85	°C
Tstg	Storage temperature range	-55 to +155	°C

⁽¹⁾ Operation of this device above any one of these parameters may cause permanent damage.**Typical Bias Conditions**

Tamb.= +25°C

Symbol	Parameter	Values	Unit
Vd1	DC Drain voltage	4	V
Vd2	DC Drain voltage	4	V
Vd3	DC Drain voltage	4	V
B	DC Gate voltage	Connected to ground or not	
D	DC Gate voltage		

Typical on-wafer Sij parameters for low current configuration

Tamb = +25°C, Vd1=Vd2=Vd3= +4V, Id = 90 mA and Pads B, D not connected

Freq (GHz)	S11 (dB)	PhS11 (°)	S12 (dB)	PhS12 (°)	S21 (dB)	PhS21 (°)	S22 (dB)	PhS22 (°)
2.0	-0.1	-23	-67.3	-16	-65.4	67	-0.2	-30
3.0	-0.1	-35	-61.6	-160	-70.6	-166	-0.3	-47
4.0	-0.2	-48	-81.4	132	-56.0	10	-0.5	-66
5.0	-0.2	-64	-60.5	-176	-33.7	-32	-1.3	-90
6.0	-0.3	-81	-63.3	-15	-16.5	-89	-3.3	-118
7.0	-0.5	-106	-59.5	-2	-1.4	-160	-8.0	-147
8.0	-1.5	-141	-61.4	73	7.4	123	-14.9	-143
9.0	-3.9	170	-55.2	-83	15.1	54	-19.6	-142
10.0	-6.7	110	-59.4	-68	19.5	-20	-14.6	-73
11.0	-6.5	53	-61.7	-76	22.2	-81	-11.6	-108
12.0	-5.0	7	-51.4	-156	23.9	-137	-12.2	-134
13.0	-4.5	-26	-51.6	176	25.1	173	-12.5	-153
14.0	-5.1	-53	-49.3	-136	25.8	126	-13.1	-178
15.0	-5.9	-67	-61.1	-1	26.2	85	-15.0	155
16.0	-5.9	-81	-44.5	67	27.3	49	-12.3	147
17.0	-8.0	-102	-47.5	60	27.7	7	-12.3	121
18.0	-8.9	-118	-47.7	20	28.7	-30	-9.9	101
19.0	-12.8	-137	-52.1	7	28.5	-72	-8.1	78
20.0	-15.3	-150	-49.2	10	28.4	-108	-7.8	56
21.0	-20.3	-172	-59.8	-56	27.9	-147	-7.3	36
22.0	-25.7	170	-72.9	24	26.9	180	-8.2	19
23.0	-26.6	105	-55.4	71	26.2	147	-8.8	9
24.0	-24.2	47	-54.5	41	25.1	116	-9.3	1
25.0	-22.4	43	-54.8	13	24.4	88	-10.2	-8
26.0	-18.9	57	-61.9	-85	24.1	60	-12.2	3
27.0	-12.0	62	-47.8	177	24.0	26	-10.1	8
28.0	-9.2	45	-63.2	-179	23.0	-4	-9.9	-1
29.0	-7.1	27	-48.4	99	22.2	-35	-9.6	-1
30.0	-5.4	15	-49.5	-2	21.2	-67	-9.0	-2
31.0	-3.5	0	-47.3	-75	19.8	-100	-7.9	-1
32.0	-2.7	-15	-47.6	-133	17.9	-133	-6.7	-9
33.0	-2.6	-29	-45.0	-160	15.5	-162	-6.1	-14
34.0	-2.6	-38	-49.3	40	12.9	172	-5.4	-22
35.0	-2.4	-46	-38.8	98	10.7	149	-4.9	-26
36.0	-2.4	-57	-45.5	124	8.2	129	-4.4	-34
37.0	-2.3	-64	-51.5	114	6.2	109	-4.0	-40
38.0	-2.7	-73	-46.1	-96	4.1	92	-4.0	-48
39.0	-3.2	-76	-56.0	142	2.4	75	-4.0	-54
40.0	-3.6	-87	-47.4	153	1.1	56	-4.1	-62

Typical on-wafer Sij parameters for high current configuration

Tamb = +25°C, Vd1=Vd2=Vd3= +4V, Id = 120 mA and Pads B, D Grounded

Freq (GHz)	S11 (dB)	PhS11 (°)	S12 (dB)	PhS12 (°)	S21 (dB)	PhS21 (°)	S22 (dB)	PhS22 (°)
2.0	-0.1	-23	-62.8	-51	-59.9	-140	-0.2	-30
3.0	-0.1	-35	-60.7	9	-58.1	-121	-0.3	-46
4.0	-0.1	-48	-63.5	-105	-54.9	31	-0.5	-65
5.0	-0.2	-63	-72.0	63	-33.8	-31	-1.2	-88
6.0	-0.3	-80	-74.5	-171	-15.8	-87	-3.2	-115
7.0	-0.5	-105	-66.5	137	-0.7	-159	-8.0	-142
8.0	-1.5	-140	-57.0	-133	8.1	124	-14.6	-133
9.0	-3.8	171	-65.6	-97	15.7	55	-17.5	-128
10.0	-6.6	112	-53.8	-100	20.1	-18	-13.4	-77
11.0	-6.5	55	-53.3	-131	22.7	-80	-10.7	-109
12.0	-5.0	9	-52.2	-152	24.5	-136	-11.4	-134
13.0	-4.6	-25	-59.8	165	25.7	174	-11.7	-152
14.0	-5.2	-51	-49.6	84	26.4	127	-13.3	-179
15.0	-6.7	-67	-45.7	147	26.6	86	-14.6	161
16.0	-6.6	-76	-44.7	79	27.3	51	-13.2	148
17.0	-7.1	-100	-48.0	85	28.4	11	-12.3	125
18.0	-9.1	-115	-60.5	63	29.0	-27	-10.2	107
19.0	-12.0	-134	-59.0	-25	29.0	-68	-8.4	78
20.0	-14.8	-142	-61.1	131	28.8	-104	-8.1	56
21.0	-18.5	-171	-56.6	-81	28.5	-142	-7.5	36
22.0	-23.6	150	-62.0	18	27.4	-176	-8.0	18
23.0	-26.6	101	-57.1	174	26.8	152	-8.7	6
24.0	-23.6	58	-59.9	150	25.9	121	-9.3	-1
25.0	-21.8	48	-56.2	22	25.3	93	-10.2	-10
26.0	-17.3	54	-56.5	-113	24.9	64	-11.9	-1
27.0	-12.9	54	-51.9	139	24.6	32	-10.8	1
28.0	-10.1	42	-49.9	-2	23.7	1	-10.1	-6
29.0	-7.3	27	-49.0	33	23.0	-30	-10.2	-3
30.0	-5.6	12	-44.7	120	22.1	-61	-9.4	-4
31.0	-4.0	1	-53.1	29	20.8	-95	-8.4	-3
32.0	-3.1	-14	-53.6	128	19.1	-129	-7.2	-8
33.0	-2.8	-27	-59.1	-80	16.6	-159	-6.2	-12
34.0	-2.8	-37	-48.0	99	14.0	174	-5.6	-20
35.0	-2.3	-46	-47.2	-155	11.6	151	-4.8	-24
36.0	-2.5	-55	-43.6	141	9.1	130	-4.3	-32
37.0	-2.3	-65	-63.3	109	6.8	110	-4.0	-39
38.0	-3.1	-75	-45.0	179	4.5	91	-3.9	-43
39.0	-3.3	-77	-46.0	101	2.4	75	-3.9	-50
40.0	-3.9	-85	-31.5	144	0.7	57	-3.5	-54

Typical on wafer Measurements

Tamb = +25°C, Vd1=Vd2=Vd3= +4V Id = 90 mA
 Pads B, D = not connected (low current configuration)

Gain and return losses versus frequency

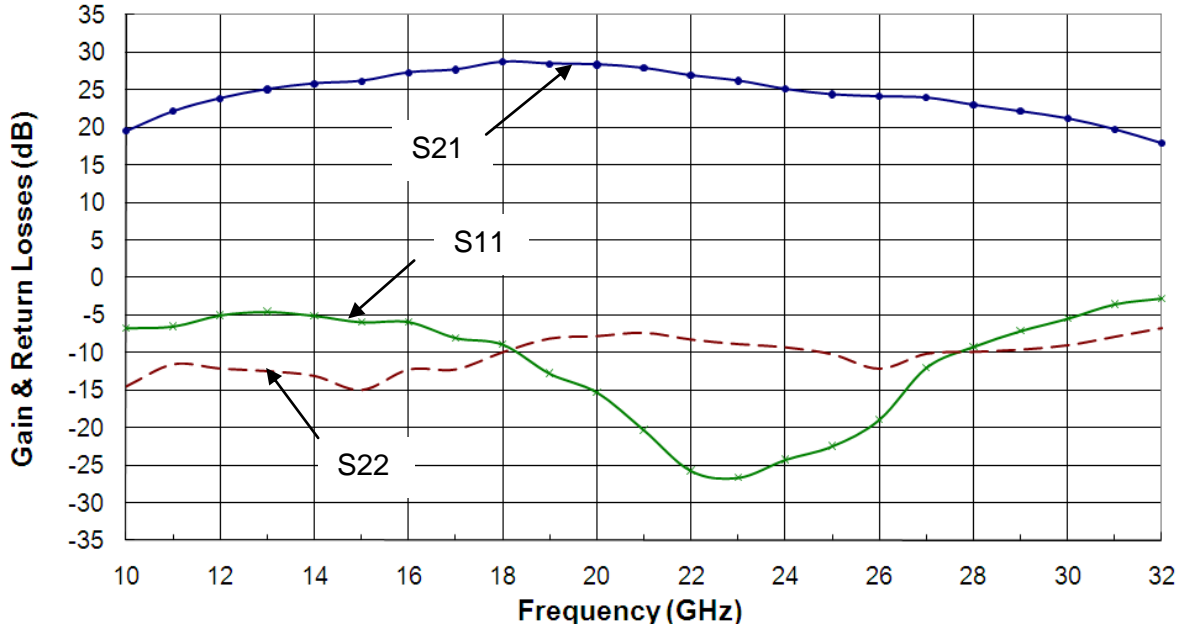

Noise figure versus frequency

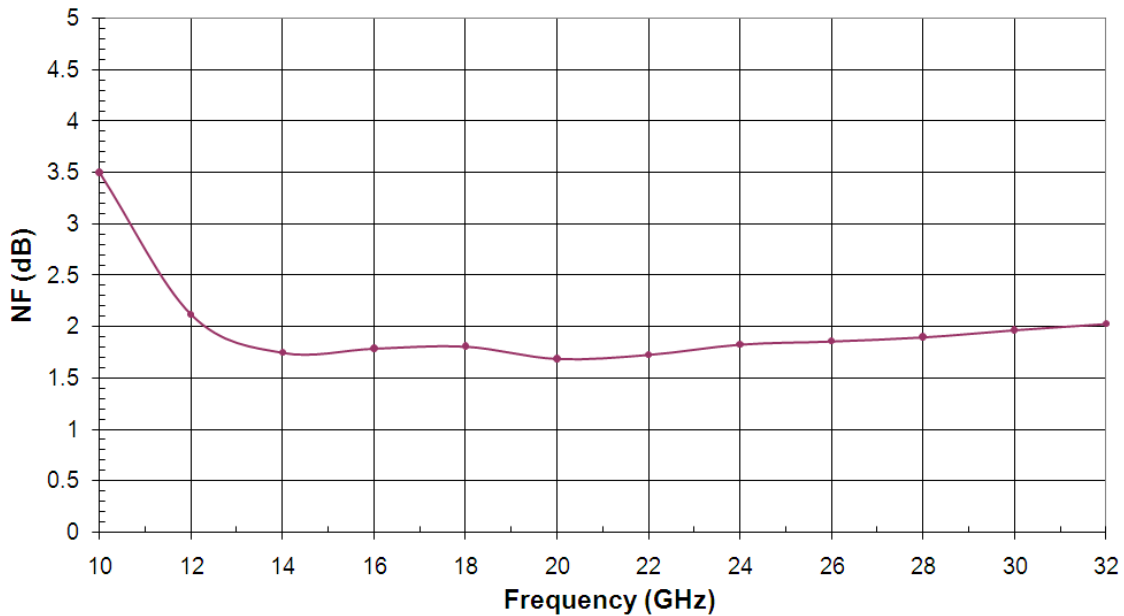

Typical on wafer Measurements

Tamb = +25°C, Vd1=Vd2=Vd3= +4V Id = 120 mA
 Pads B, D = GND (high current configuration)

Gain and return losses versus frequency

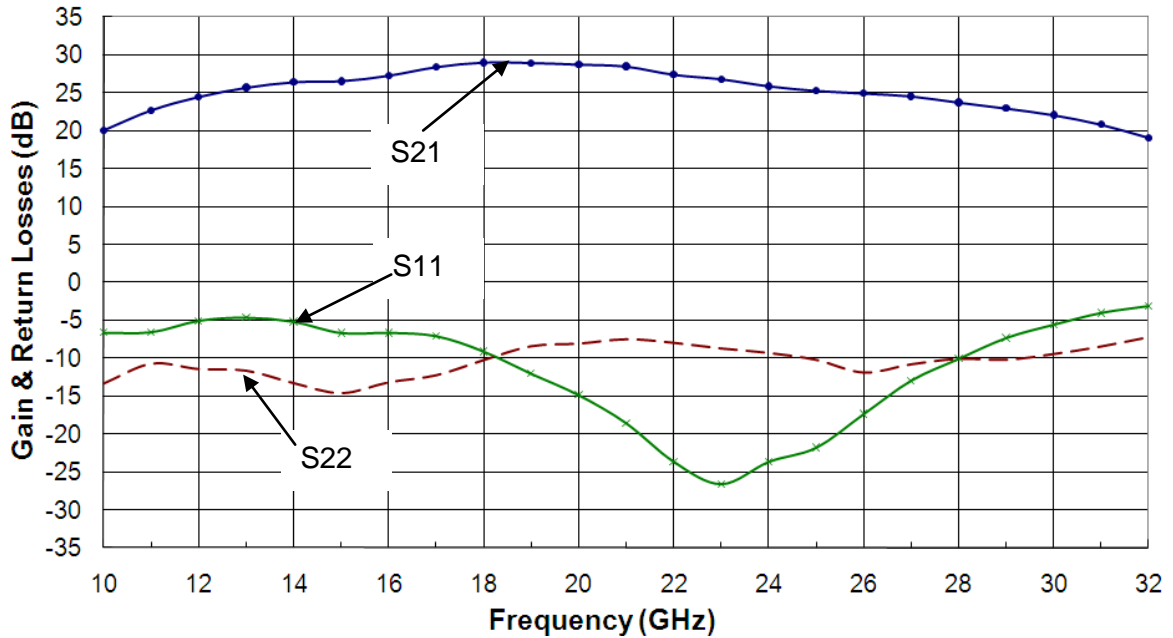

Noise figure versus frequency

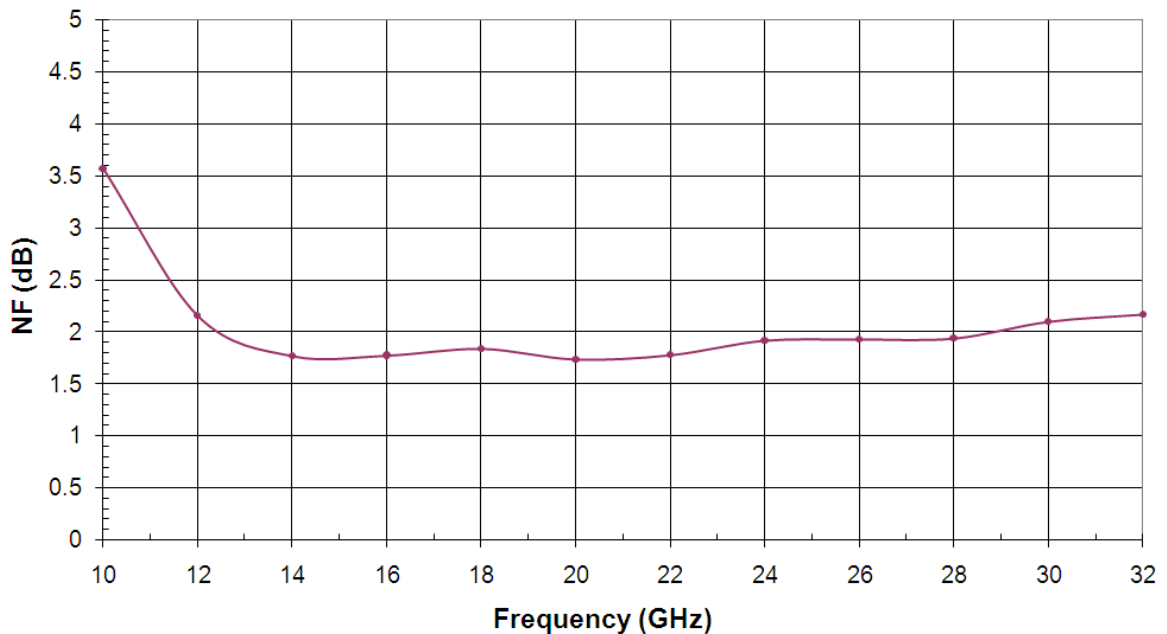

Typical on wafer Measurements

Tamb = +25°C, Vd1=Vd2=Vd3= +4V Id = 90/120 mA

Output power -1dB for low and high current configurations

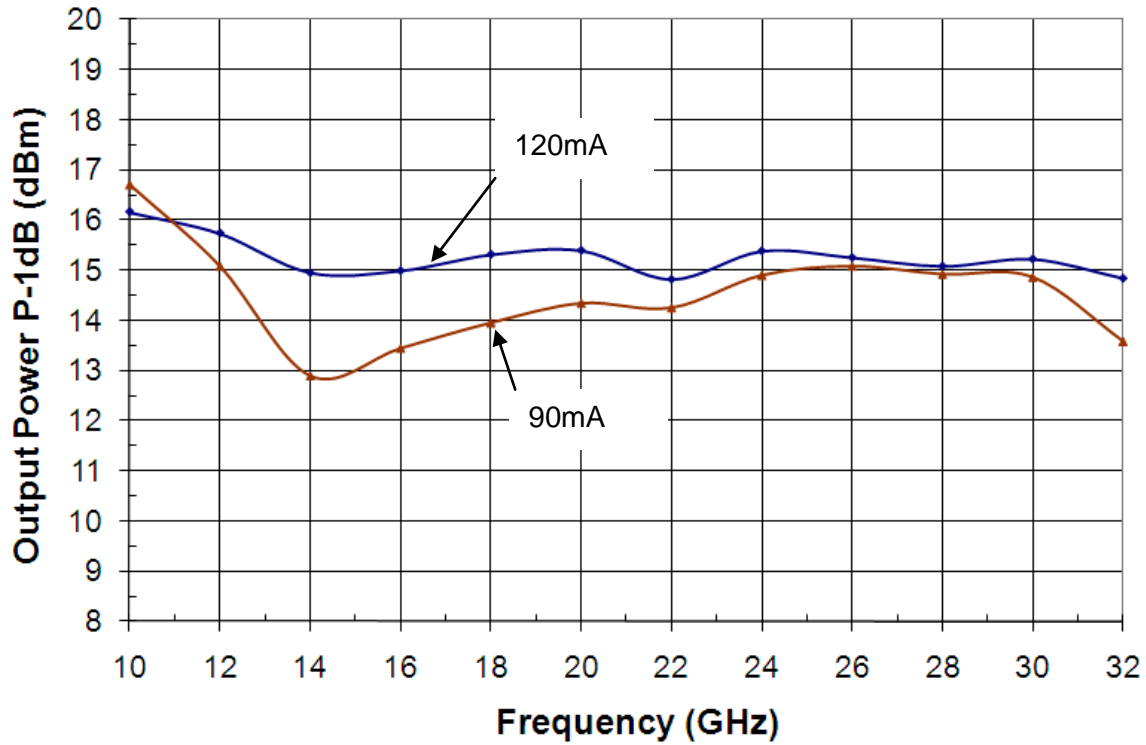

Typical Test Fixture Measurements

Tamb = -40°C / +25°C / +85°C, Vd1=Vd2=Vd3= +4V

Measurements are given in the connectors' access plans. Losses are not de-embedded.

**Gain measurement for low current configuration
Pads B, D = not connected**

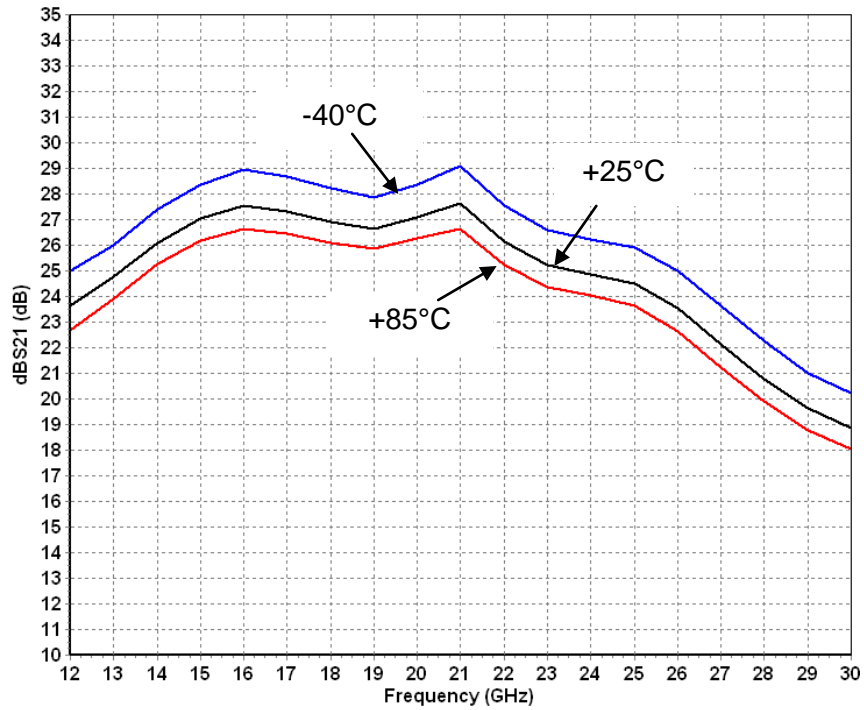

**Gain measurement for high current configuration
Pads B, D = GND**

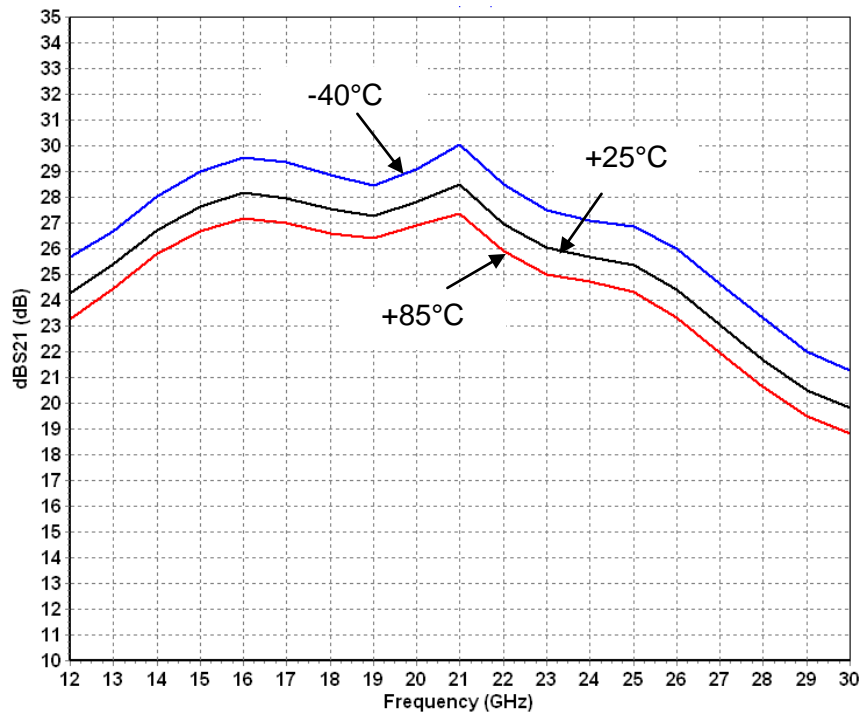

Typical Test Fixture Measurements

Tamb = -40°C / +25°C / +85°C, Vd1=Vd2=Vd3= +4V

Measurements are given in the connectors' access plans. Losses are not de-embedded.

**Return losses for low current configuration
Pads B, D = not connected**

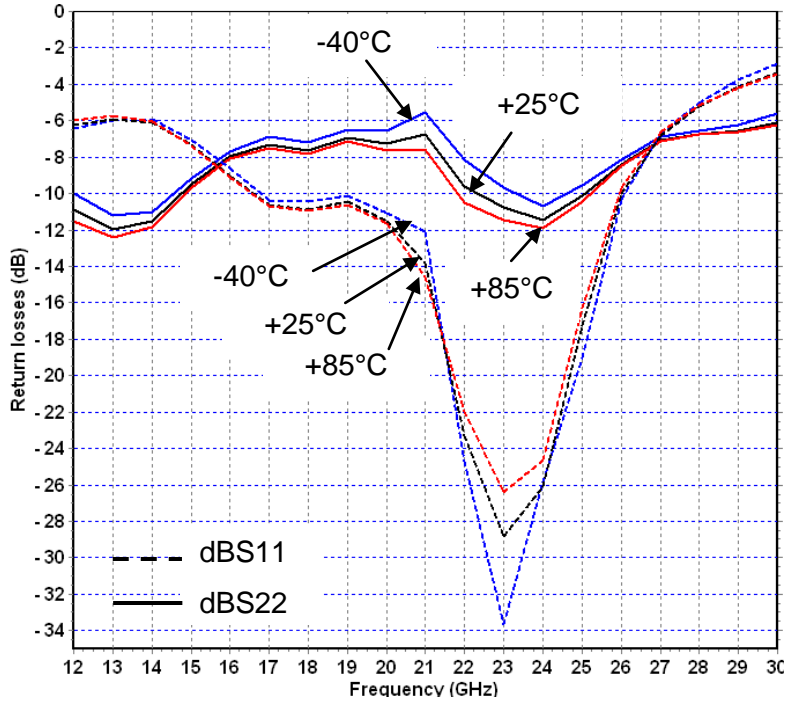

**Return losses for high current configuration
Pads B, D = GND**

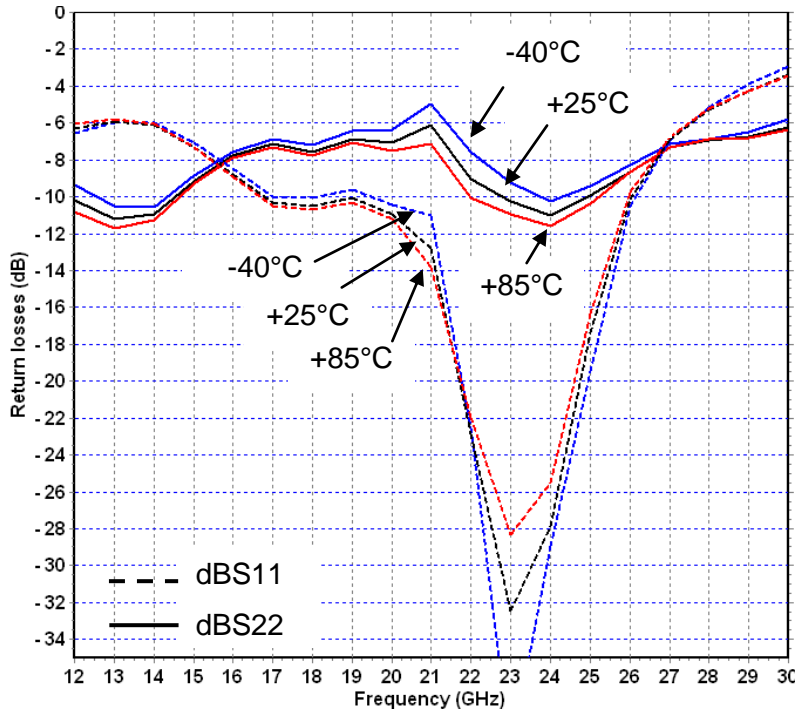

Typical Test Fixture Measurements

Tamb = -40°C / +25°C / +85°C, Vd1=Vd2=Vd3= +4V Id = 90 mA

Pads B, D = GND (high current configuration)

Measurements are given in the connectors' access plans. Losses are not de-embedded.

Output IP3 versus input power @ 18GHz

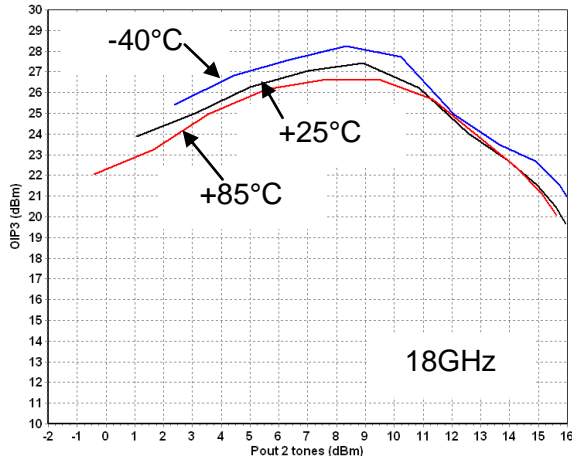

Output IP3 versus input power @ 22GHz

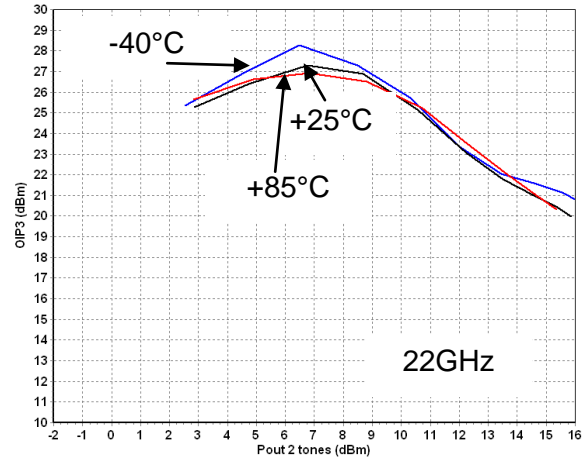

Output IP3 versus input power @ 26GHz

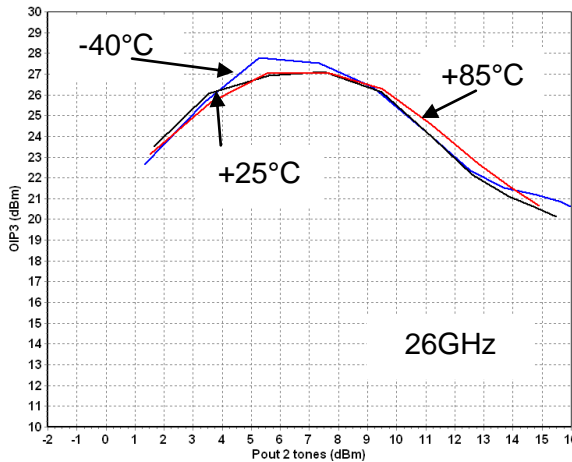

Output IP3 versus input power @ 30GHz

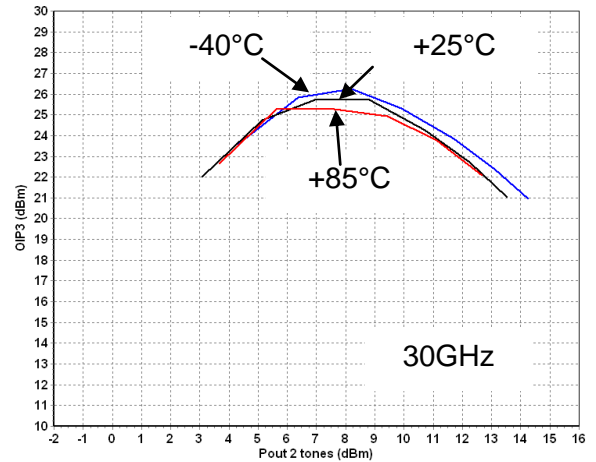

Typical Test Fixture Measurements

Tamb = -40°C / +25°C / +85°C, Vd1=Vd2=Vd3= +4V Id = 120 mA

Pads B, D = not connected (**low current configuration**)

Measurements are given in the connectors' access plans. Losses are not de-embedded.

Output IP3 versus input power @ 18GHz

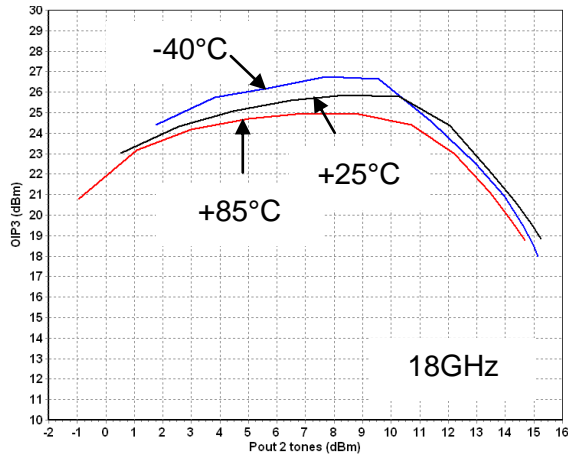

Output IP3 versus input power @ 22GHz

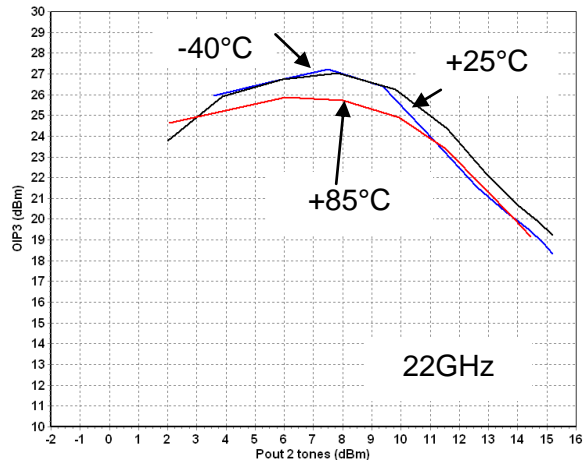

Output IP3 versus input power @ 26GHz

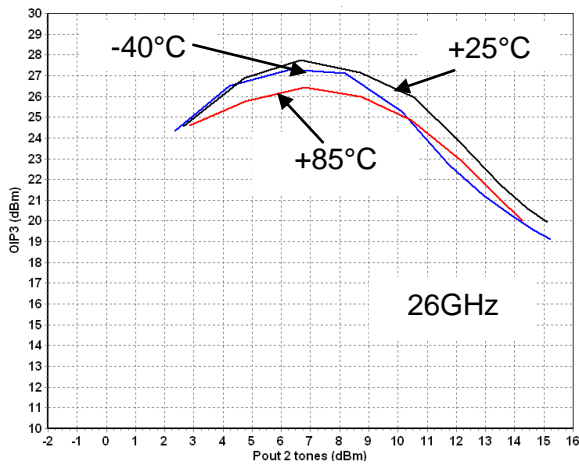

Output IP3 versus input power @ 30GHz

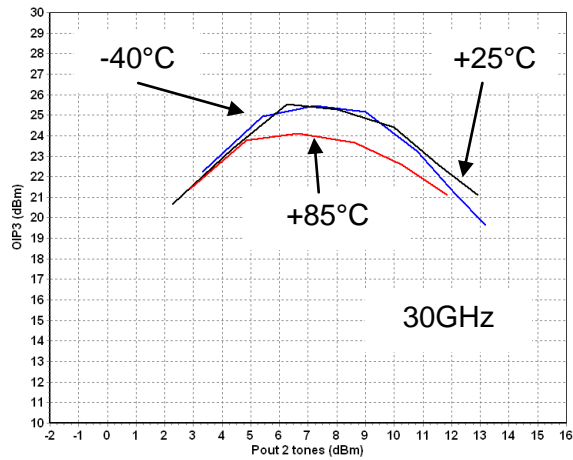

Mechanical data

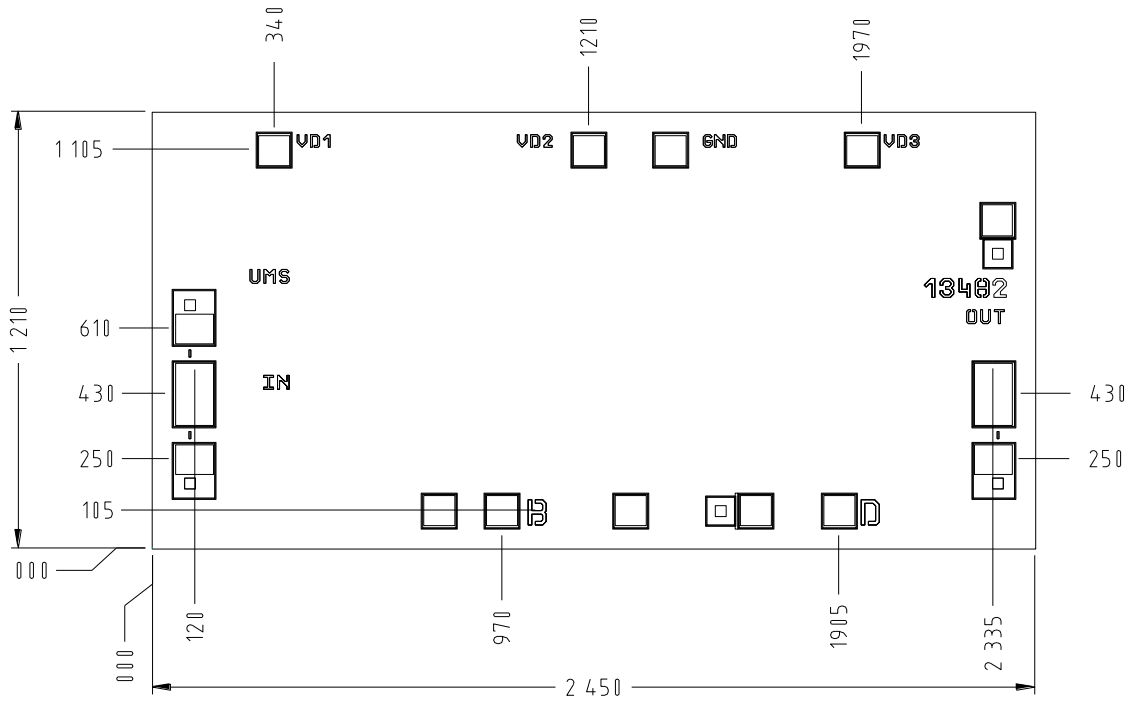

DC Pads Size: 100/100 μm , Chip thickness: 100 μm
 Chip size: 2.45 x 1.21 x 0.1mm $\pm 35\mu\text{m}$
 All dimensions are in micrometers

Recommended assembly plan

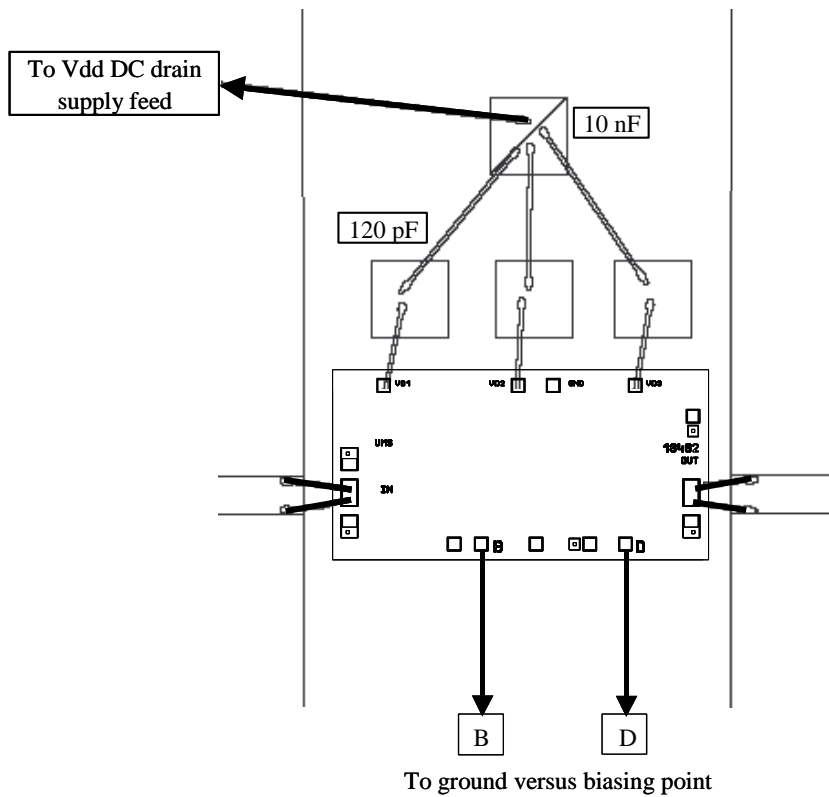

25µm wedge bonding is preferred

Note: Supply feed should be bypassed.

Chip Biasing options

This chip is self-biased, and flexibility is provided by the access to number of pads. The internal DC electrical schematic is given in order to use these pads in a safe way.

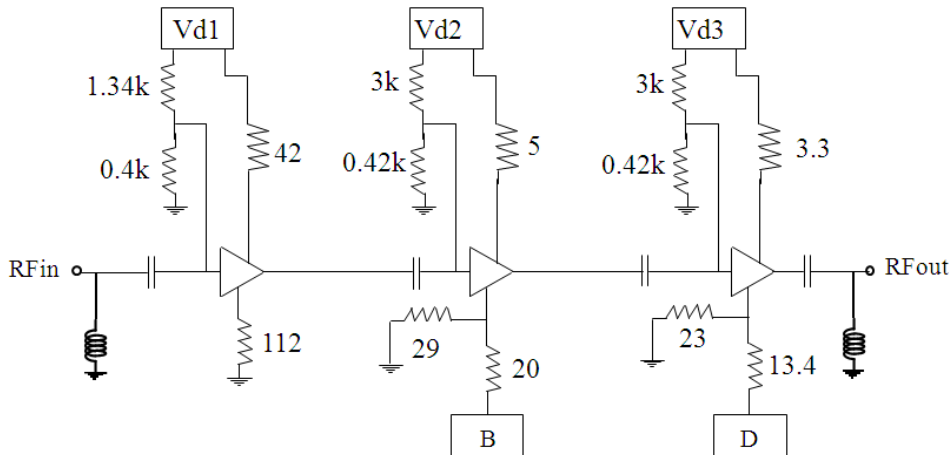

The requirement is not to exceed $V_{ds} = 3.5\text{Volt}$ (internal Drain to Source voltage).

We propose two standard biasings:

- Low Noise and low consumption: $V_d = 4\text{V}$ and B, D not connected (NC).
 $I_{dd} = 90\text{mA}$ & $P_{out-1\text{dB}} = 14\text{dBm}$ Typical
- Low Noise and higher output power: $V_d = 4\text{V}$ and B, D grounded.
 $I_{dd} = 120\text{mA}$ & $P_{out-1\text{dB}} = 15\text{dBm}$ Typical

Recommended ESD management

Refer to the application note AN0020 available at <http://www.ums-gaas.com> for ESD sensitivity and handling recommendations for the UMS products.

Ordering Information

Chip form:

CHA3689-99F/00

Information furnished is believed to be accurate and reliable. However **United Monolithic Semiconductors S.A.S.** assumes no responsibility for the consequences of use of such information nor for any infringement of patents or other rights of third parties which may result from its use. No license is granted by implication or otherwise under any patent or patent rights of **United Monolithic Semiconductors S.A.S.** Specifications mentioned in this publication are subject to change without notice. This publication supersedes and replaces all information previously supplied. **United Monolithic Semiconductors S.A.S.** products are not authorised for use as critical components in life support devices or systems without express written approval from **United Monolithic Semiconductors S.A.S.**