



PART NUMBER	DESCRIPTION
CCR-39S	Commercial Latching Multi-throw, DC-18GHz
CR-39S	Elite Latching Multi-throw, DC-22GHz



The CCR-39S/CR-39S is a broadband, multi-throw, electromechanical coaxial switch designed to switch a microwave signal from a common input to any of 3, 4, 5, or 6 outputs. The characteristic impedance is 50 Ohms. The switches are small using the popular connector spacing on a 1.062" dia. circle. Each position has an individual actuator mechanism allowing random position selection. This also minimizes switching time.

The CCR-39S/CR-39S comes with a latching actuator. The latching switch remains in the last position selected when the switch is de-energized. STD dual command requires a reset pulse before a new selected position. A separate reset circuit allows all positions to be set to an open position. User must provide both reset (clear) and set (select new position) commands.

ENVIRONMENTAL AND PHYSICAL CHARACTERISTICS	
Operating Temperature	
Commercial Model, CCR-39S	-40°C to 65°C
Elite Model, CR-39S	-55°C to 85°C
Vibration (MIL-STD-202 Method 214, Condition D, non-operating)	10 g's RMS
Shock (MIL-STD-202 Method 213, Condition D, non-operating)	500 g's
Standard Actuator Life	5,000,000 cycles
Actuator Life w/ Additional Features	1,000,000 cycles
Connector Type	SMA
Humidity (Moisture Seal)	Available
Weight	6 oz. (170.1g) (max.)

ELECTRICAL CHARACTERISTICS	
Form Factor	Multi-Throw, break before make
Frequency Range	
CCR-39S	DC-18 GHz
CR-39S	DC-22 GHz
Characteristic Impedance	50 Ohms
Operate Time	20 ms (max.)
Actuation Voltage Available	12 15 24 28 V
Actuation Current	255 205 130 90 mA
Reset Current (# of Positions)	3 765 615 390 270 mA
	4 1020 820 520 360 mA
	5 1275 1025 650 450 mA
	6 1530 1230 780 540 mA

PERFORMANCE CHARACTERISTICS						
Frequency	DC-4 GHz	4-8 GHz	8-12 GHz	12-16 GHz	16-20 GHz	20-22 GHz
Insertion Loss, dB, max.	0.1	0.2	0.2	0.3	0.3	0.4
Isolation, dB, min.	80	80	80	80	75	70
VSWR, max.	1.05:1	1.1:1	1.2:1	1.2:1	1.2:1	1.2:1

**PART NUMBERING SYSTEM**

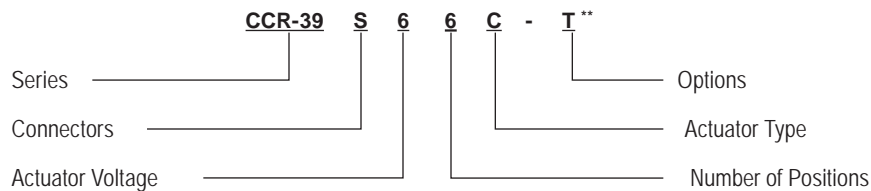

CONNECTOR	ACTUATOR VOLTAGE	NUMBER OF POSITIONS	ACTUATOR TYPE	OPTIONS
S: SMA FEMALE	6: 28 VDC LATCHING	3: SP3T	0: NO INDICATOR CONTACTS	T: TTL DRIVERS WITH DIODES
	7: 15 VDC LATCHING	4: SP4T	C: INDICATOR CONTACTS	D: COIL TRANSIENT SUPPRESSION DIODES
	8: 12 VDC LATCHING	5: SP5T		R: POSITIVE + COMMON
	9: 24 VDC LATCHING	6: SP6T		TD: DECODERS AND TTL DRIVERS WITH DIODES
				M: MOISTURE SEAL
				S: D-SUB CONNECTOR*

\*\* SEE PARTS LIST ON PAGE 11-13

**For additional options, please contact factory.**

\* D-Sub Connector may be 9 or 15 pin depending on number of throws. (See Connector Pinout page)

# Series CCR-39S/CR-39S

Multi-Throw DC-18 GHz/DC-22 GHz  
Latching Coaxial Switch



## SCHEMATICS AND MECHANICAL OUTLINE

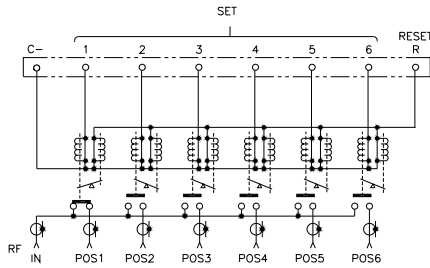

Analog

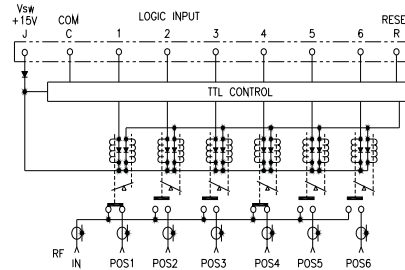

TTL

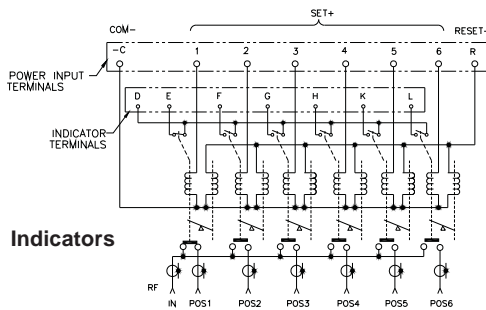

Indicators

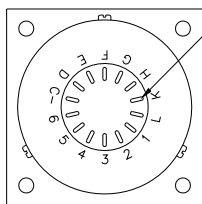

14X SOLDER TERMINALS  
SOLDER WIRE MAXIMUM  
TEMP 250°C FOR NO  
MORE THAN 5 SEC

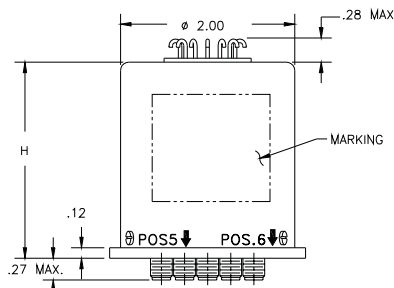

H = 2.25 STD & Indicator Model  
H = 2.50 All OTHER Models

SP3T

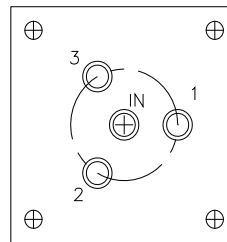

SP5T

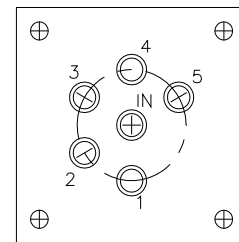

SP6T

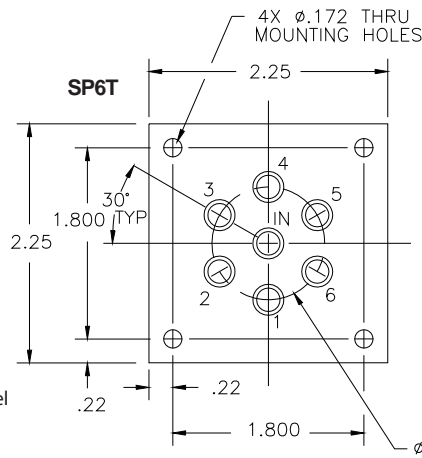

SP4T

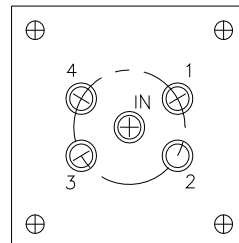

“-S OPTION” 9-PIN D-SUB OR 15-PIN D-MICRO CONNECTOR (EXAMPLE: CCR-39S660-S)

CONNECTOR PINOUT FOR LATCHING SP3T MULTI-THROW SWITCHES						
EXAMPLE	CR-39S630-S	CR-39S63C-S	CR-39S630-TS	CR-39S63C-TS	CR-39S630-TDS	CR-39S63C-TDS
INDICATOR		Yes		Yes		Yes
TTL			Yes	Yes		
DECODERS & TTL					Yes	Yes
PIN NO.	9-PIN	9-PIN	9-PIN	15-PIN	9-PIN	9-PIN
1	PORT 1	PORT 1	TTL 1	TTL 1	LOGIC 1	LOGIC 1
2	PORT 2	PORT 2	TTL 2	TTL 2	LOGIC 2	LOGIC 2
3	PORT 3	PORT 3	TTL 3	TTL 3	LOGIC 3	LOGIC 3
4		E INDICATOR				E INDICATOR
5		F INDICATOR				F INDICATOR
6		G INDICATOR				G INDICATOR
7	COMMON	COMMON	COMMON	COMMON	COMMON	COMMON
8	RESET	RESET	RESET	RESET		D INDICATOR (COM)
9		D INDICATOR (COM)	Vsw	Vsw	Vsw	Vsw
10				D INDICATOR (COM)		
11				E INDICATOR		
12				F INDICATOR		
13				G INDICATOR		
14						
15	N/A	N/A	N/A		N/A	N/A

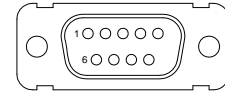

**9-PIN D-SUB CONNECTOR**

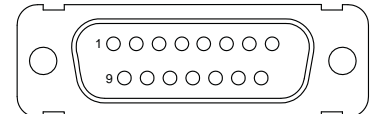

**15-PIN D-SUB CONNECTOR**

CONNECTOR PINOUT FOR LATCHING SP4T MULTI-THROW SWITCHES						
EXAMPLE	CR-39S640-S	CR-39S64C-S	CR-39S640-TS	CR-39S64C-TS	CR-39S640-TDS	CR-39S64C-TDS
INDICATOR		Yes		Yes		Yes
TTL			Yes	Yes		
DECODERS & TTL					Yes	Yes
PIN NO.	9-PIN	15-PIN	9-PIN	15-PIN	9-PIN	9-PIN
1	PORT 1	PORT 1	TTL 1	TTL 1	LOGIC 1	LOGIC 1
2	PORT 2	PORT 2	TTL 2	TTL 2	LOGIC 2	LOGIC 2
3	PORT 3	PORT 3	TTL 3	TTL 3	LOGIC 3	LOGIC 3
4	PORT 4	PORT 4	TTL 4	TTL 4		
5						
6						
7	COMMON	COMMON	COMMON	COMMON	COMMON	COMMON
8	RESET	RESET	RESET	RESET		
9			Vsw	Vsw	Vsw	Vsw
10		D INDICATOR (COM)		D INDICATOR (COM)		D INDICATOR (COM)
11		E INDICATOR		E INDICATOR		E INDICATOR
12		F INDICATOR		F INDICATOR		F INDICATOR
13		G INDICATOR		G INDICATOR		G INDICATOR
14		H INDICATOR		H INDICATOR		H INDICATOR
15	N/A		N/A		N/A	

CONNECTOR PINOUT FOR LATCHING SP5T MULTI-THROW SWITCHES						
EXAMPLE	CR-39S650-S	CR-39S65C-S	CR-39S650-TS	CR-39S65C-TS	CR-39S650-TDS	CR-39S65C-TDS
INDICATOR		Yes		Yes		Yes
TTL			Yes	Yes		
DECODERS & TTL					Yes	Yes
PIN NO.	9-PIN	15-PIN	9-PIN	15-PIN	9-PIN	15-PIN
1	PORT 1	PORT 1	TTL 1	TTL 1	LOGIC 1	LOGIC 1
2	PORT 2	PORT 2	TTL 2	TTL 2	LOGIC 2	LOGIC 2
3	PORT 3	PORT 3	TTL 3	TTL 3	LOGIC 3	LOGIC 3
4	PORT 4	PORT 4	TTL 4	TTL 4		
5	PORT 5	PORT 5	TTL 5	TTL 5		
6						
7	COMMON	COMMON	COMMON	COMMON	COMMON	COMMON
8	RESET	RESET	RESET	RESET		
9			Vsw	Vsw	Vsw	Vsw
10		D INDICATOR (COM)		D INDICATOR (COM)		D INDICATOR (COM)
11		E INDICATOR		E INDICATOR		E INDICATOR
12		F INDICATOR		F INDICATOR		F INDICATOR
13		G INDICATOR		G INDICATOR		G INDICATOR
14		H INDICATOR		H INDICATOR		H INDICATOR
15		K INDICATOR		K INDICATOR		K INDICATOR

CONNECTOR PINOUT FOR LATCHING SP6T MULTI-THROW SWITCHES						
EXAMPLE	CR-39S660-S	CR-39S66C-S	CR-39S660-TS	CR-39S66C-TS	CR-39S660-TDS	CR-39S66C-TDS
INDICATOR		Yes				Yes
TTL			Yes			
DECODERS & TTL					Yes	Yes
PIN NO.	9-PIN	15-PIN	9-PIN		9-PIN	15-PIN
1	PORT 1	PORT 1	TTL 1		LOGIC 1	LOGIC 1
2	PORT 2	PORT 2	TTL 2		LOGIC 2	LOGIC 2
3	PORT 3	PORT 3	TTL 3		LOGIC 3	LOGIC 3
4	PORT 4	PORT 4	TTL 4			
5	PORT 5	PORT 5	TTL 5			
6	PORT 6	PORT 6	TTL 6			
7	COMMON	COMMON	COMMON		COMMON	COMMON
8	RESET	RESET	RESET			
9		D INDICATOR (COM)	Vsw		Vsw	D INDICATOR (COM)
10		E INDICATOR				E INDICATOR
11		F INDICATOR				F INDICATOR
12		G INDICATOR				G INDICATOR
13		H INDICATOR				H INDICATOR
14		K INDICATOR				K INDICATOR
15		L INDICATOR				L INDICATOR

**Series CCR-39S/CR-39S**  
**Multi-Throw DC-18 GHz/DC-22 GHz**  
**Latching Coaxial Switch**



**TRUTH TABLE Latching**  
**CCR-39SX3C-T**

Logic Input				RF Path				Indicator Switches		
1	2	3	R	J1	J2	J3	Reset	E	F	G
1	0	0	0	On	Off	Off	Off	C	0	0
0	1	0	0	Off	On	Off	Off	0	C	0
0	0	1	0	Off	Off	On	Off	0	0	C

**TRUTH TABLE Latching**  
**CCR-39SX3C-TD**

Logic Input			RF Path				Indicator Switches		
1	2	3	J1	J2	J3	Reset	E	F	G
0	0	0	On	Off	Off	Off	C	0	0
1	0	0	Off	On	Off	Off	0	C	0
0	1	0	Off	Off	On	Off	0	0	C
0	1	1	Off	Off	Off	Reset	0	0	0
1	1	1	COIL OFF				0	0	0

**TRUTH TABLE Latching**  
**CCR-39SX4C-T**

Logic Input					RF Path					Indicator Switches			
1	2	3	4	R	J1	J2	J3	J4	Reset	E	F	G	H
1	0	0	0	0	On	Off	Off	Off	Off	C	0	0	0
0	1	0	0	0	Off	On	Off	Off	Off	0	C	0	0
0	0	1	0	0	Off	Off	On	Off	Off	0	0	C	0
0	0	0	1	0	Off	Off	Off	On	Off	0	0	0	C

**TRUTH TABLE Latching**  
**CCR-39SX4C-TD**

Logic Input			RF Path					Indicator Switches			
1	2	3	J1	J2	J3	J4	Reset	E	F	G	H
0	0	0	On	Off	Off	Off	Off	C	0	0	0
1	0	0	Off	On	Off	Off	Off	0	C	0	0
0	1	0	Off	Off	On	Off	Off	0	0	C	0
1	1	0	Off	Off	Off	On	Off	0	0	0	C
0	1	1	Off	Off	Off	Off	Reset	0	0	0	0
1	1	1	COIL OFF					0	0	0	0

**TRUTH TABLE Latching**  
CCR-39SX5C-T

Logic Input						RF Path						Indicator Switches				
1	2	3	4	5	R	J1	J2	J3	J4	J5	Reset	E	F	G	H	K
1	0	0	0	0	0	On	Off	Off	Off	Off	Off	C	0	0	0	0
0	1	0	0	0	0	Off	On	Off	Off	Off	Off	0	C	0	0	0
0	0	1	0	0	0	Off	Off	On	Off	Off	Off	0	0	C	0	0
0	0	0	1	0	0	Off	Off	Off	On	Off	Off	0	0	0	C	0
0	0	0	0	1	0	Off	Off	Off	Off	On	Off	0	0	0	0	C

**TRUTH TABLE Latching**  
CCR-39SX5C-TD

Logic Input			RF Path					Indicator Switches					
1	2	3	J1	J2	J3	J4	J5	Reset	E	F	G	H	K
0	0	0	On	Off	Off	Off	Off	Off	C	0	0	0	0
1	0	0	Off	On	Off	Off	Off	Off	0	C	0	0	0
0	1	0	Off	Off	On	Off	Off	Off	0	0	C	0	0
1	1	0	Off	Off	Off	On	Off	Off	0	0	0	C	0
0	0	1	Off	Off	Off	Off	On	Off	0	0	0	0	C
0	1	1	Off	Off	Off	Off	Off	Reset	0	0	0	0	0
1	1	1	COIL OFF					0	0	0	0	0	

**TRUTH TABLE Latching**  
CCR-39SX6C-T

Logic Input							RF Path						Indicator Switches						
1	2	3	4	5	6	R	J1	J2	J3	J4	J5	J6	Reset	E	F	G	H	K	L
1	0	0	0	0	0	0	On	Off	Off	Off	Off	Off	Off	C	0	0	0	0	0
0	1	0	0	0	0	0	Off	On	Off	Off	Off	Off	Off	0	C	0	0	0	0
0	0	1	0	0	0	0	Off	Off	On	Off	Off	Off	Off	0	0	C	0	0	0
0	0	0	1	0	0	0	Off	Off	Off	On	Off	Off	Off	0	0	0	C	0	0
0	0	0	0	1	0	0	Off	Off	Off	Off	On	Off	Off	0	0	0	0	C	0
0	0	0	0	0	1	0	Off	Off	Off	Off	Off	On	Off	0	0	0	0	0	C

**TRUTH TABLE Latching**  
CCR-39SX6C-TD

Logic Input			RF Path						Indicator Switches						
1	2	3	J1	J2	J3	J4	J5	J6	Reset	E	F	G	H	K	L
0	0	0	On	Off	Off	Off	Off	Off	Off	C	0	0	0	0	0
1	0	0	Off	On	Off	Off	Off	Off	Off	0	C	0	0	0	0
0	1	0	Off	Off	On	Off	Off	Off	Off	0	0	C	0	0	0
1	1	0	Off	Off	Off	On	Off	Off	Off	0	0	0	C	0	0
0	0	1	Off	Off	Off	Off	On	Off	Off	0	0	0	0	C	0
1	0	1	Off	Off	Off	Off	Off	On	Off	0	0	0	0	0	C
0	1	1	Off	Off	Off	Off	Off	Off	Reset	0	0	0	0	0	0
1	1	1	COIL OFF						0	0	0	0	0	0	

**TYPICAL NARROWBAND RF INSERTION LOSS PERFORMANCE CURVES**

Insertion Loss ( DC-4 GHz )

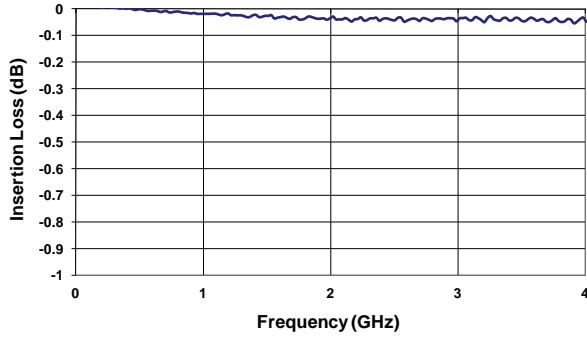

Insertion Loss ( 4-8 GHz )

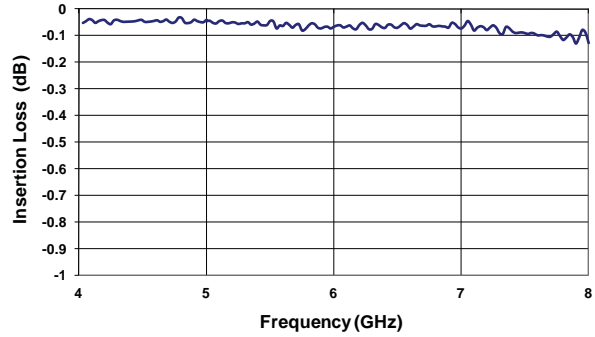

Insertion Loss ( 8-12 GHz )

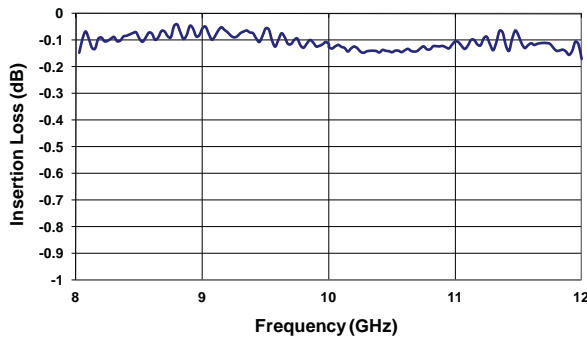

Insertion Loss ( 12-16 GHz )

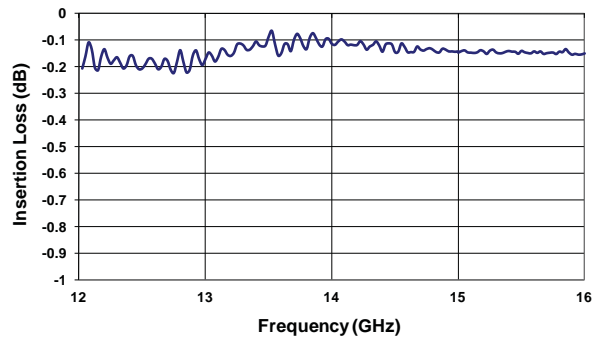

Insertion Loss ( 16-20 GHz )

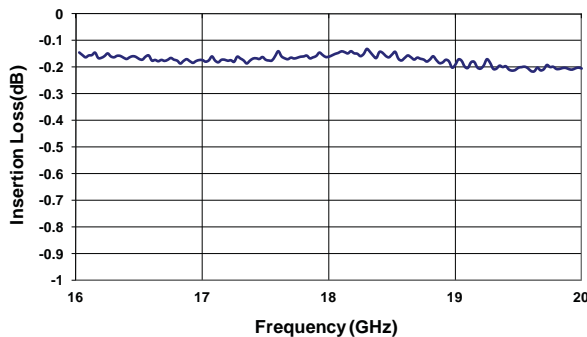

Insertion Loss ( 20-22 GHz )

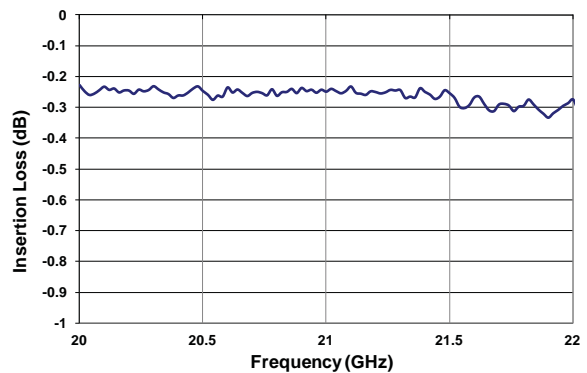

18GHz+ ELITE MODEL ONLY

RF NOTES

[Empty box for RF notes]

**TYPICAL NARROWBAND RF ISOLATION PERFORMANCE CURVES**

Isolation (DC-4 GHz)

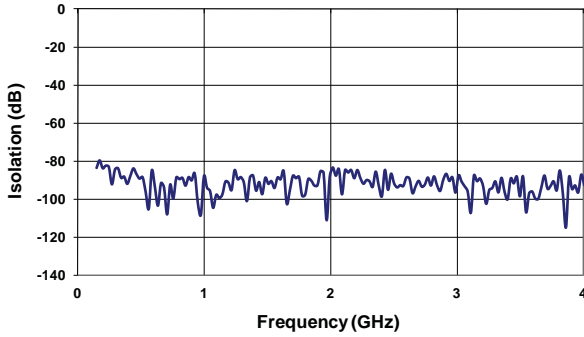

Isolation (4-8 GHz)

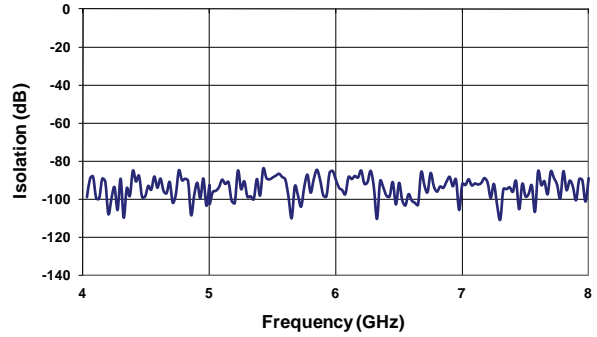

Isolation (8-12 GHz)

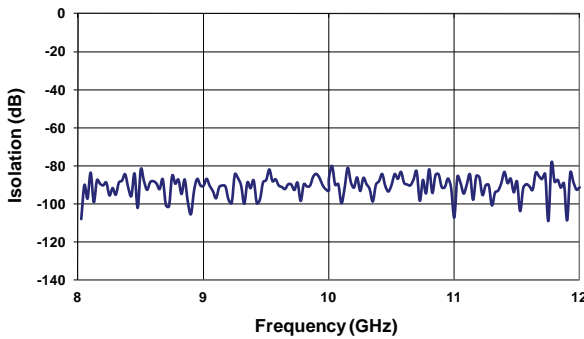

Isolation (12-16 GHz)

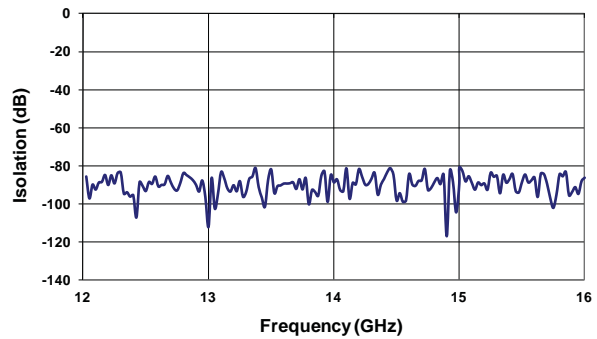

Isolation (16-20 GHz)

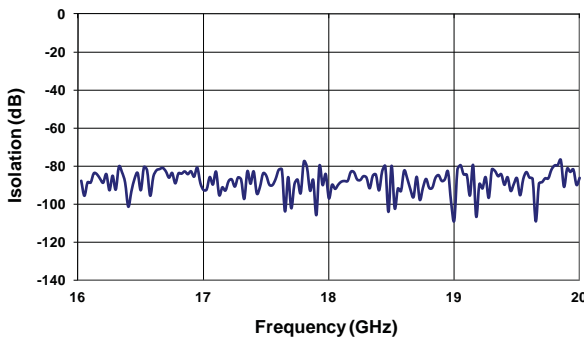

Isolation (20-22 GHz)

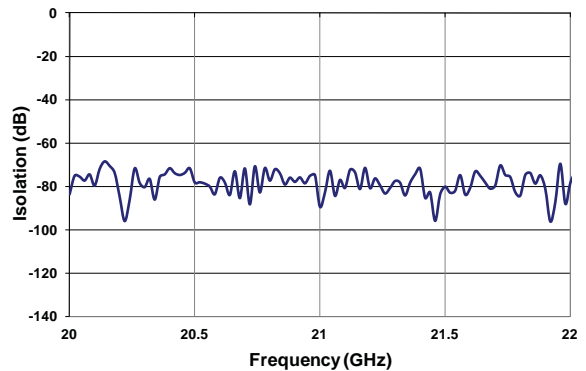

18GHz+ ELITE MODEL ONLY

RF NOTES

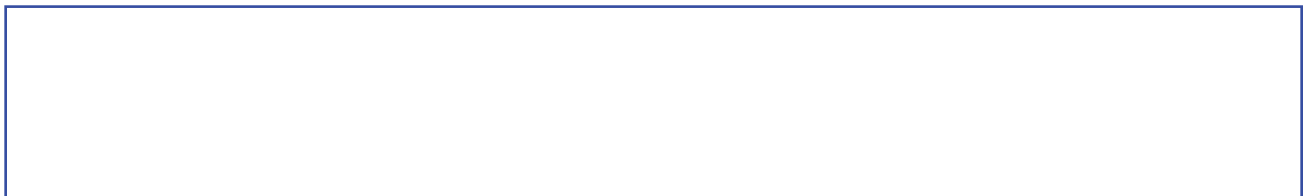

**TYPICAL NARROWBAND RF VSWR PERFORMANCE CURVES**

VSWR ( DC-4 GHz )

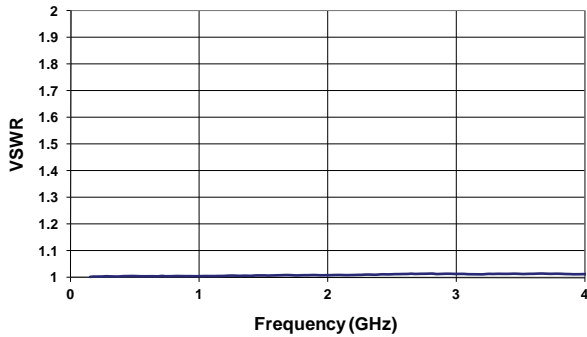

VSWR ( 4-8 GHz )

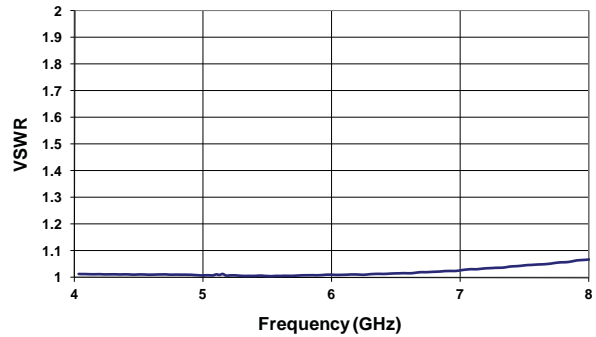

VSWR ( 8-12 GHz )

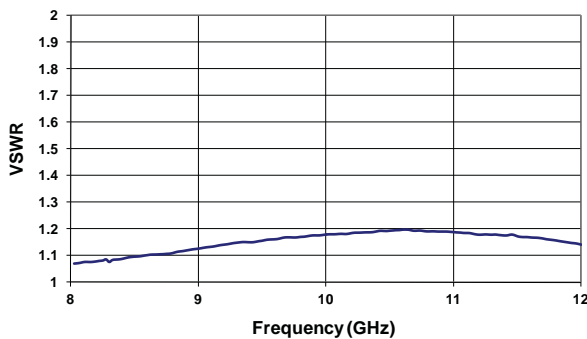

VSWR ( 12-16 GHz )

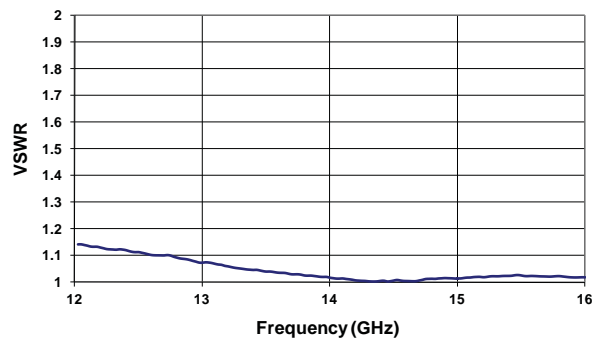

VSWR ( 16-20 GHz )

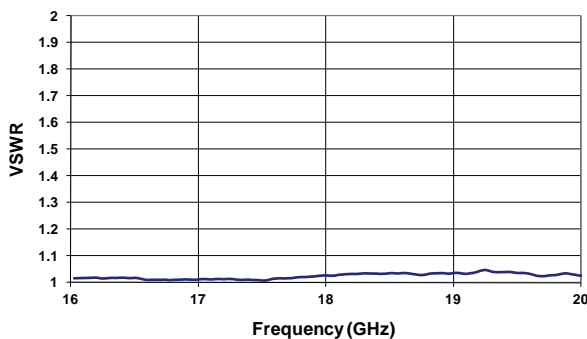

VSWR ( 20-22 GHz )

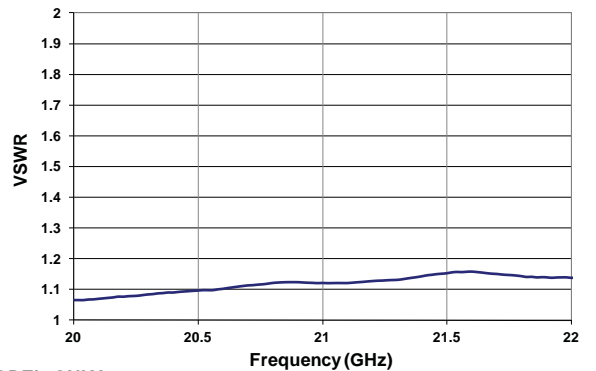

RF NOTES

18GHz+ ELITE MODEL ONLY

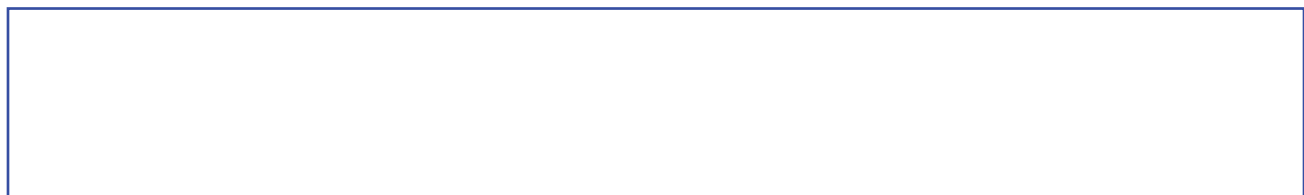



**TYPICAL POWER PERFORMANCE CURVE**

# Power Handling vs. Frequency

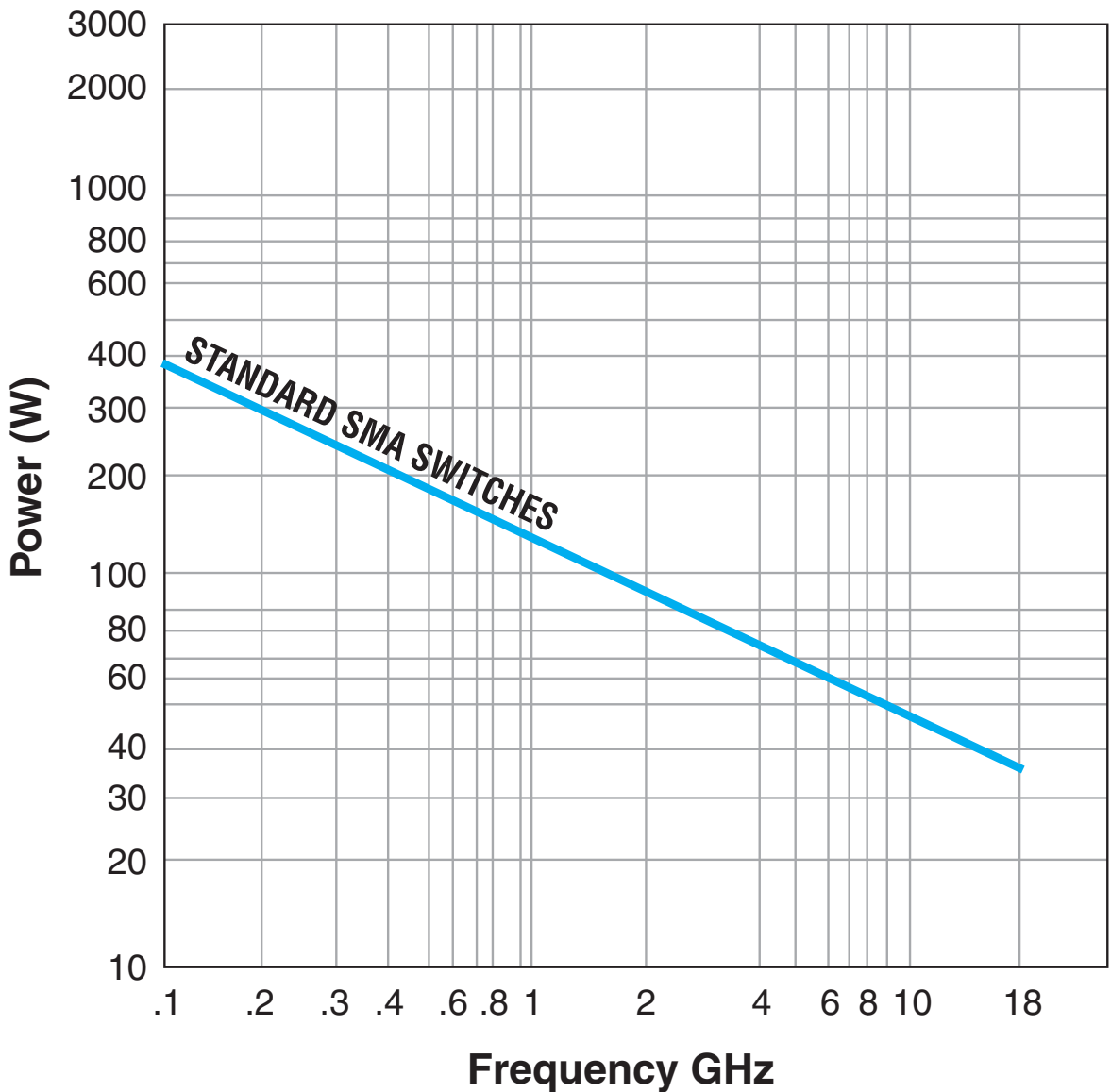

Estimates based on the following reference conditions:

- Ambient temperature of 40°C or less
- Sea level operation
- Load VSWR of 1.20:1 maximum
- No high-power (hot) switching

Please contact Teledyne Coax Switches for derating factors when applications do not meet the foregoing reference conditions.

**GLOSSARY**

**Actuator**

An actuator is the electromechanical mechanism that transfers the RF contacts from one position to another upon DC command.

**Arc Suppression Diode**

A diode is connected in parallel with the coil. This diode limits the "reverse EMF spike" generated when the coil de-energizes to 0.7 volts. The diode cathode is connected to the positive side of the coil and the anode is connected to the negative side.

**Date Code**

All switches are marked with either a unique serial number or a date code. Date codes are in accordance with MIL-STD-1285 Paragraph 5.2.5 and consist of four digits. The first two digits define the year and the last two digits define the week of the year (YYWW). Thus, 1032 identifies switches that passed through final inspection during the 32nd week of 2010.

**Indicator**

Indicators tell the system which position the switch is in. Other names for indicators are telemetry contacts or tellback circuit. Indicators are usually a set of internally mounted DC contacts linked to the actuator. They can be wired to digital input lines, status lights, or interlocks. Unless otherwise specified, the maximum indicator contact rating is 30 Vdc, 50 mA, or 1.5 Watts into a resistive load.

**Isolation**

Isolation is the measure of the power level at the output connector of an unconnected RF channel as referenced to the power at the input connector. It is specified in dB below the input power level.

**Multi-Throw Latching Switch**

A multi-throw switch is a switch with one input and three or more output ports. The CCR-39 can switch a microwave signal to any of 2,3,4,5 or 6 output from a single common input.

- DUAL PULSE SWITCHING COMMAND CHARACTERISTICS:
1. APPLIES FOR SINGLE-POLE MULTI-THROW LATCHING SWITCH ONLY.
  2. MUST APPLY RESET PULSE FIRST (BREAK-BEFORE-MAKE).
  3. RESET AND SET DEFINITIONS  
 RESET: OPEN ALL RF PATHS (POSITIONS).  
 SET: CLOSE THE SELECTED RF PATH (POSITION).
  4. COMMAND PULSE TIMING:

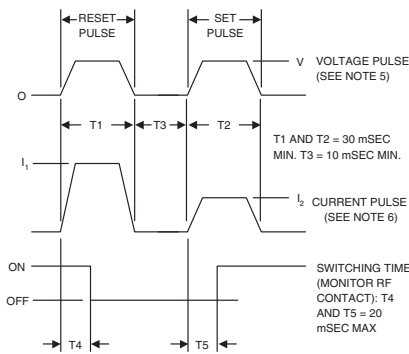

5. COMMAND SWITCHING VOLTAGE:  
 V = 26-32 VDC PULSE
6. SWITCHING CURRENT:

SWITCHING CURRENT AT 28 VDC AND 20°C		
NO. OF POS.	RESET (I <sub>1</sub> )	SET (I <sub>2</sub> )
3 POS.	270 mA	90 mA
4 POS.	360 mA	90 mA
5 POS.	450 mA	90 mA
6 POS.	540 mA	90 mA

**Switching Time**

Switching time is the total interval beginning with the arrival of the leading edge of the command pulse at the switch DC input and ending with the completion of the switch transfer, including contact bounce. It consists of three parts: (1) inductive delay in the coil, (2) transfer time of the physical movement of the contacts, and (3) the bounce time of the RF contacts.

**TTL Switch Driver Option**

As a special option, switch drivers can be provided for both failsafe and latching switches, which are compatible with industry-standard low-power Schottky TTL circuits.

**TD-Option**

This option includes a decoder. The 3-bit parallel command is decoded to internally select the appropriate position. See the logic tables. The TD-Option increases the Vsw supply current demand by 50mA max at 28Vdc and +20°C.

**Performance Parameters vs Frequency**

Generally speaking, the RF performance of coaxial switches is frequency dependent. With increasing frequency, VSWR and insertion loss increase while isolation decreases. All data sheets specify these three parameters as "worst case" at the highest operating frequency. If the switch is to be used over a narrow frequency band, better performance can be achieved.

**Actuator Current vs Temperature**

The resistance of the actuator coil varies as a function of temperature. There is an inverse relationship between the operating temperature of the switch and the actuator drive current. For switches operating at 28 VDC, the approximate actuator drive current at temperature, T, can be calculated using the equation:

$$I_T = \frac{I_A}{[1 + .00385 (T-20)]}$$

Where:

I<sub>T</sub> = Actuator current at temperature, T

I<sub>A</sub> = Room temperature actuator current – see data sheet

T = Temperature of interest in °C

**Magnetic Sensitivity**

An electro-mechanical switch can be sensitive to ferrous materials and external magnetic fields. Neighboring ferrous materials should be permitted no closer than 0.5 inches and adjacent external magnetic fields should be limited to a flux density of less than 5 Gauss.

**SPECIAL FEATURE**

**Switching High-Power or Highly Sensitive Signals**

Ensure the most linear response with the best galvanically matched contact system in the industry. Extremely low passive intermodulation is standard on all of our switches.

Carrier Frequency 1	Carrier Frequency 2	PIM 3rd Order Frequency	PIM 5th Order Frequency
870 MHz	893 MHz	847 MHz	824 MHz

	3rd Order Intermodulation	5th Order Intermodulation
Multiple Positions	-96 dBm	-115 dBm
	-139 dBc	-158 dBc

**LATCHING CCR-39S/CR-39S PART NUMBER LIST**

	PART No.		PART No.		PART No.		PART No.
1	CCR-39SX3C	43	CCR-39SX30-TMS	85	CCR-39SX40-TDS	127	CCR-39SX50-TDM
2	CCR-39SX3C-D	44	CCR-39SX30-TS	86	CCR-39SX40-TM	128	CCR-39SX50-TDMS
3	CCR-39SX3C-DM	45	CCR-39SX4C	87	CCR-39SX40-TMS	129	CCR-39SX50-TDS
4	CCR-39SX3C-DR	46	CCR-39SX4C-D	88	CCR-39SX40-TS	130	CCR-39SX50-TM
5	CCR-39SX3C-DRM	47	CCR-39SX4C-DM	89	CCR-39SX5C	131	CCR-39SX50-TMS
6	CCR-39SX3C-DRS	48	CCR-39SX4C-DR	90	CCR-39SX5C-D	132	CCR-39SX50-TS
7	CCR-39SX3C-DS	49	CCR-39SX4C-DRM	91	CCR-39SX5C-DM	133	CCR-39SX6C
8	CCR-39SX3C-M	50	CCR-39SX4C-DRS	92	CCR-39SX5C-DR	134	CCR-39SX6C-D
9	CCR-39SX3C-MS	51	CCR-39SX4C-DS	93	CCR-39SX5C-DRM	135	CCR-39SX6C-DM
10	CCR-39SX3C-R	52	CCR-39SX4C-M	94	CCR-39SX5C-DRS	136	CCR-39SX6C-DR
11	CCR-39SX3C-RM	53	CCR-39SX4C-MS	95	CCR-39SX5C-DS	137	CCR-39SX6C-DRM
12	CCR-39SX3C-RMS	54	CCR-39SX4C-R	96	CCR-39SX5C-M	138	CCR-39SX6C-DRS
13	CCR-39SX3C-RS	55	CCR-39SX4C-RM	97	CCR-39SX5C-MS	139	CCR-39SX6C-DS
14	CCR-39SX3C-S	56	CCR-39SX4C-RMS	98	CCR-39SX5C-R	140	CCR-39SX6C-M
15	CCR-39SX3C-T	57	CCR-39SX4C-RS	99	CCR-39SX5C-RM	141	CCR-39SX6C-MS
16	CCR-39SX3C-TD	58	CCR-39SX4C-S	100	CCR-39SX5C-RMS	142	CCR-39SX6C-R
17	CCR-39SX3C-TDM	59	CCR-39SX4C-T	101	CCR-39SX5C-RS	143	CCR-39SX6C-RM
18	CCR-39SX3C-TDMS	60	CCR-39SX4C-TD	102	CCR-39SX5C-S	144	CCR-39SX6C-RMS
19	CCR-39SX3C-TDS	61	CCR-39SX4C-TDM	103	CCR-39SX5C-T	145	CCR-39SX6C-RS
20	CCR-39SX3C-TM	62	CCR-39SX4C-TDMS	104	CCR-39SX5C-TD	146	CCR-39SX6C-S
21	CCR-39SX3C-TMS	63	CCR-39SX4C-TDS	105	CCR-39SX5C-TDM	147	CCR-39SX6C-T
22	CCR-39SX3C-TS	64	CCR-39SX4C-TM	106	CCR-39SX5C-TDMS	148	CCR-39SX6C-TD
23	CCR-39SX30	65	CCR-39SX4C-TMS	107	CCR-39SX5C-TDS	149	CCR-39SX6C-TDM
24	CCR-39SX30-D	66	CCR-39SX4C-TS	108	CCR-39SX5C-TM	150	CCR-39SX6C-TDMS
25	CCR-39SX30-DM	67	CCR-39SX40	109	CCR-39SX5C-TMS	151	CCR-39SX6C-TDS
26	CCR-39SX30-DR	68	CCR-39SX40-D	110	CCR-39SX5C-TS	152	CCR-39SX6C-TM
27	CCR-39SX30-DRM	69	CCR-39SX40-DM	111	CCR-39SX50	153	CCR-39SX6C-TMS
28	CCR-39SX30-DRS	70	CCR-39SX40-DR	112	CCR-39SX50-D	154	CCR-39SX6C-TS
29	CCR-39SX30-DS	71	CCR-39SX40-DRM	113	CCR-39SX50-DM	155	CCR-39SX60
30	CCR-39SX30-M	72	CCR-39SX40-DRS	114	CCR-39SX50-DR	156	CCR-39SX60-D
31	CCR-39SX30-MS	73	CCR-39SX40-DS	115	CCR-39SX50-DRM	157	CCR-39SX60-DM
32	CCR-39SX30-R	74	CCR-39SX40-M	116	CCR-39SX50-DRS	158	CCR-39SX60-DR
33	CCR-39SX30-RM	75	CCR-39SX40-MS	117	CCR-39SX50-DS	139	CCR-39SX60-DRM
34	CCR-39SX30-RMS	76	CCR-39SX40-R	118	CCR-39SX50-M	160	CCR-39SX60-DRS
35	CCR-39SX30-RS	77	CCR-39SX40-RM	119	CCR-39SX50-MS	161	CCR-39SX60-DS
36	CCR-39SX30-S	78	CCR-39SX40-RMS	120	CCR-39SX50-R	162	CCR-39SX60-M
37	CCR-39SX30-T	79	CCR-39SX40-RS	121	CCR-39SX50-RM	163	CCR-39SX60-MS
38	CCR-39SX30-TD	80	CCR-39SX40-S	122	CCR-39SX50-RMS	164	CCR-39SX60-R
39	CCR-39SX30-TDM	81	CCR-39SX40-T	123	CCR-39SX50-RS	165	CCR-39SX60-RM
40	CCR-39SX30-TDMS	82	CCR-39SX40-TD	124	CCR-39SX50-S	166	CCR-39SX60-RMS
41	CCR-39SX30-TDS	83	CCR-39SX40-TDM	125	CCR-39SX50-T	167	CCR-39SX60-RS
42	CCR-39SX30-TM	84	CCR-39SX40-TDMS	126	CCR-39SX50-TD	168	CCR-39SX60-S

\* X = 6 (28Vdc), 7 (15Vdc), 8 (12Vdc) and 9 (24Vdc)

**Series CCR-39S/CR-39S**  
Multi-Throw DC-18 GHz/DC-22 GHz  
Latching Coaxial Switch



**LATCHING CCR-39S/CR-39S PART NUMBER LIST**

	PART No.		PART No.		PART No.		PART No.
169	CCR-39SX60-T	211	CR-39SX30-RS	253	CR-39SX40-RM	295	CR-39SX50-MS
170	CCR-39SX60-TD	212	CR-39SX30-S	254	CR-39SX40-RMS	296	CR-39SX50-R
171	CCR-39SX60-TDM	213	CR-39SX30-T	255	CR-39SX40-RS	297	CR-39SX50-RM
172	CCR-39SX60-TDMS	214	CR-39SX30-TD	256	CR-39SX40-S	298	CR-39SX50-RMS
173	CCR-39SX60-TDS	215	CR-39SX30-TDM	257	CR-39SX40-T	299	CR-39SX50-RS
174	CCR-39SX60-TM	216	CR-39SX30-TDMS	258	CR-39SX40-TD	300	CR-39SX50-S
175	CCR-39SX60-TMS	217	CR-39SX30-TDS	239	CR-39SX40-TDM	301	CR-39SX50-T
176	CCR-39SX60-TS	218	CR-39SX30-TM	260	CR-39SX40-TDMS	302	CR-39SX50-TD
177	CR-39SX3C	219	CR-39SX30-TMS	261	CR-39SX40-TDS	303	CR-39SX50-TDM
178	CR-39SX3C-D	220	CR-39SX30-TS	262	CR-39SX40-TM	304	CR-39SX50-TDMS
179	CR-39SX3C-DM	221	CR-39SX4C	263	CR-39SX40-TMS	305	CR-39SX50-TDS
180	CR-39SX3C-DR	222	CR-39SX4C-D	264	CR-39SX40-TS	306	CR-39SX50-TM
181	CR-39SX3C-DRM	223	CR-39SX4C-DM	265	CR-39SX5C	307	CR-39SX50-TMS
182	CR-39SX3C-DRS	224	CR-39SX4C-DR	266	CR-39SX5C-D	308	CR-39SX50-TS
183	CR-39SX3C-DS	225	CR-39SX4C-DRM	267	CR-39SX5C-DM	309	CR-39SX6C
184	CR-39SX3C-M	226	CR-39SX4C-DRS	268	CR-39SX5C-DR	310	CR-39SX6C-D
185	CR-39SX3C-MS	227	CR-39SX4C-DS	269	CR-39SX5C-DRM	311	CR-39SX6C-DM
186	CR-39SX3C-R	228	CR-39SX4C-M	270	CR-39SX5C-DRS	312	CR-39SX6C-DR
187	CR-39SX3C-RM	229	CR-39SX4C-MS	271	CR-39SX5C-DS	313	CR-39SX6C-DRM
188	CR-39SX3C-RMS	230	CR-39SX4C-R	272	CR-39SX5C-M	314	CR-39SX6C-DRS
189	CR-39SX3C-RS	231	CR-39SX4C-RM	273	CR-39SX5C-MS	315	CR-39SX6C-DS
190	CR-39SX3C-S	232	CR-39SX4C-RMS	274	CR-39SX5C-R	316	CR-39SX6C-M
191	CR-39SX3C-T	233	CR-39SX4C-RS	275	CR-39SX5C-RM	317	CR-39SX6C-MS
192	CR-39SX3C-TD	234	CR-39SX4C-S	276	CR-39SX5C-RMS	318	CR-39SX6C-R
193	CR-39SX3C-TDM	235	CR-39SX4C-T	277	CR-39SX5C-RS	319	CR-39SX6C-RM
194	CR-39SX3C-TDMS	236	CR-39SX4C-TD	278	CR-39SX5C-S	320	CR-39SX6C-RMS
195	CR-39SX3C-TDS	237	CR-39SX4C-TDM	279	CR-39SX5C-T	321	CR-39SX6C-RS
196	CR-39SX3C-TM	238	CR-39SX4C-TDMS	280	CR-39SX5C-TD	322	CR-39SX6C-S
197	CR-39SX3C-TMS	239	CR-39SX4C-TDS	281	CR-39SX5C-TDM	323	CR-39SX6C-T
198	CR-39SX3C-TS	240	CR-39SX4C-TM	282	CR-39SX5C-TDMS	324	CR-39SX6C-TD
199	CR-39SX30	241	CR-39SX4C-TMS	283	CR-39SX5C-TDS	325	CR-39SX6C-TDM
200	CR-39SX30-D	242	CR-39SX4C-TS	284	CR-39SX5C-TM	326	CR-39SX6C-TDMS
201	CR-39SX30-DM	243	CR-39SX40	285	CR-39SX5C-TMS	327	CR-39SX6C-TDS
202	CR-39SX30-DR	244	CR-39SX40-D	286	CR-39SX5C-TS	328	CR-39SX6C-TM
203	CR-39SX30-DRM	245	CR-39SX40-DM	287	CR-39SX50	329	CR-39SX6C-TMS
204	CR-39SX30-DRS	246	CR-39SX40-DR	288	CR-39SX50-D	330	CR-39SX6C-TS
205	CR-39SX30-DS	247	CR-39SX40-DRM	289	CR-39SX50-DM	331	CR-39SX60
206	CR-39SX30-M	248	CR-39SX40-DRS	290	CR-39SX50-DR	332	CR-39SX60-D
207	CR-39SX30-MS	249	CR-39SX40-DS	291	CR-39SX50-DRM	333	CR-39SX60-DM
208	CR-39SX30-R	250	CR-39SX40-M	292	CR-39SX50-DRS	334	CR-39SX60-DR
209	CR-39SX30-RM	251	CR-39SX40-MS	293	CR-39SX50-DS	335	CR-39SX60-DRM
210	CR-39SX30-RMS	252	CR-39SX40-R	294	CR-39SX50-M	336	CR-39SX60-DRS

\* X = 6 (28Vdc), 7 (15Vdc), 8 (12Vdc) and 9 (24Vdc)

**LATCHING CCR-39S/CR-39S PART NUMBER LIST**

	<b>PART No.</b>
<b>337</b>	CR-39SX60-DS
<b>338</b>	CR-39SX60-M
<b>339</b>	CR-39SX60-MS
<b>340</b>	CR-39SX60-R
<b>341</b>	CR-39SX60-RM
<b>342</b>	CR-39SX60-RMS
<b>343</b>	CR-39SX60-RS
<b>344</b>	CR-39SX60-S
<b>345</b>	CR-39SX60-T
<b>346</b>	CR-39SX60-TD
<b>347</b>	CR-39SX60-TDM
<b>348</b>	CR-39SX60-TDMS
<b>349</b>	CR-39SX60-TDS
<b>350</b>	CR-39SX60-TM
<b>351</b>	CR-39SX60-TMS
<b>352</b>	CR-39SX60-TS

\* X = 6 (28Vdc), 7 (15Vdc), 8 (12Vdc) and 9 (24Vdc)