

**POWER MOS V® FREDFET**

Power MOS V® is a new generation of high voltage N-Channel enhancement mode power MOSFETs. This new technology minimizes the JFET effect, increases packing density and reduces the on-resistance. Power MOS V® also achieves faster switching speeds through optimized gate layout.

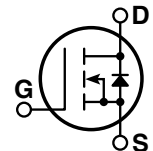
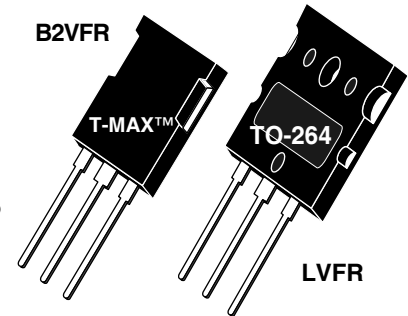

- Fast Recovery Body Diode
- Lower Leakage
- Faster Switching
- Avalanche Energy Rated
- T-MAX™ or TO-264 Package

**MAXIMUM RATINGS**

 All Ratings:  $T_C = 25^\circ\text{C}$  unless otherwise specified.

Symbol	Parameter	APT30M40B2VFR_LVFR	UNIT
$V_{DSS}$	Drain-Source Voltage	300	Volts
$I_D$	Continuous Drain Current @ $T_C = 25^\circ\text{C}$	76	Amps
$I_{DM}$	Pulsed Drain Current <sup>①</sup>	304	
$V_{GS}$	Gate-Source Voltage Continuous	$\pm 30$	Volts
$V_{GSM}$	Gate-Source Voltage Transient	$\pm 40$	
$P_D$	Total Power Dissipation @ $T_C = 25^\circ\text{C}$	520	Watts
	Linear Derating Factor	4.16	W/°C
$T_J, T_{STG}$	Operating and Storage Junction Temperature Range	-55 to 150	°C
$T_L$	Lead Temperature: 0.063" from Case for 10 Sec.	300	
$I_{AR}$	Avalanche Current <sup>①</sup> (Repetitive and Non-Repetitive)	76	Amps
$E_{AR}$	Repetitive Avalanche Energy <sup>①</sup>	50	mJ
$E_{AS}$	Single Pulse Avalanche Energy <sup>④</sup>	2500	

**STATIC ELECTRICAL CHARACTERISTICS**

Symbol	Characteristic / Test Conditions	MIN	TYP	MAX	UNIT
$BV_{DSS}$	Drain-Source Breakdown Voltage ( $V_{GS} = 0V, I_D = 250\mu\text{A}$ )	300			Volts
$I_{D(on)}$	On State Drain Current <sup>②</sup> ( $V_{DS} > I_{D(on)} \times R_{DS(on)}$ Max, $V_{GS} = 10V$ )	76			Amps
$R_{DS(on)}$	Drain-Source On-State Resistance <sup>②</sup> ( $V_{GS} = 10V, 0.5 I_{D[Cont.]}$ )			0.040	Ohms
$I_{DSS}$	Zero Gate Voltage Drain Current ( $V_{DS} = V_{DSS}, V_{GS} = 0V$ )			250	$\mu\text{A}$
	Zero Gate Voltage Drain Current ( $V_{DS} = 0.8 V_{DSS}, V_{GS} = 0V, T_C = 125^\circ\text{C}$ )			1000	
$I_{GSS}$	Gate-Source Leakage Current ( $V_{GS} = \pm 30V, V_{DS} = 0V$ )			$\pm 100$	nA
$V_{GS(th)}$	Gate Threshold Voltage ( $V_{DS} = V_{GS}, I_D = 2.5\text{mA}$ )	2		4	Volts

 **CAUTION:** These Devices are Sensitive to Electrostatic Discharge. Proper Handling Procedures Should Be Followed.

APT Website - <http://www.advancedpower.com>

**DYNAMIC CHARACTERISTICS**

**APT30M40B2VFR\_LVFR**

Symbol	Characteristic	Test Conditions	MIN	TYP	MAX	UNIT
$C_{iss}$	Input Capacitance	$V_{GS} = 0V$		8500	10200	pF
$C_{oss}$	Output Capacitance	$V_{DS} = 25V$		1500	2100	
$C_{rss}$	Reverse Transfer Capacitance	$f = 1\text{ MHz}$		390	585	
$Q_g$	Total Gate Charge <sup>③</sup>	$V_{GS} = 10V$		285	425	nC
$Q_{gs}$	Gate-Source Charge	$V_{DD} = 0.5 V_{DSS}$		56	85	
$Q_{gd}$	Gate-Drain ("Miller") Charge	$I_D = I_D [\text{Cont.}] @ 25^\circ\text{C}$		120	180	
$t_{d(on)}$	Turn-on Delay Time	$V_{GS} = 15V$		16	32	ns
$t_r$	Rise Time	$V_{DD} = 0.5 V_{DSS}$		20	40	
$t_{d(off)}$	Turn-off Delay Time	$I_D = I_D [\text{Cont.}] @ 25^\circ\text{C}$		48	72	
$t_f$	Fall Time	$R_G = 0.6\Omega$		4	8	

**SOURCE-DRAIN DIODE RATINGS AND CHARACTERISTICS**

Symbol	Characteristic / Test Conditions	MIN	TYP	MAX	UNIT
$I_S$	Continuous Source Current (Body Diode)			76	Amps
$I_{SM}$	Pulsed Source Current <sup>①</sup> (Body Diode)			304	
$V_{SD}$	Diode Forward Voltage <sup>②</sup> ( $V_{GS} = 0V, I_S = -I_D [\text{Cont.}]$ )			1.3	Volts
$dv/dt$	Peak Diode Recovery $dv/dt$ <sup>⑤</sup>			5	V/ns
$t_{rr}$	Reverse Recovery Time ( $I_S = -I_D [\text{Cont.}], di/dt = 100A/\mu s$ )	$T_j = 25^\circ\text{C}$		240	ns
		$T_j = 125^\circ\text{C}$		500	
$Q_{rr}$	Reverse Recovery Charge ( $I_S = -I_D [\text{Cont.}], di/dt = 100A/\mu s$ )	$T_j = 25^\circ\text{C}$		1.1	$\mu\text{C}$
		$T_j = 125^\circ\text{C}$		5.2	
$I_{RRM}$	Peak Recovery Current ( $I_S = -I_D [\text{Cont.}], di/dt = 100A/\mu s$ )	$T_j = 25^\circ\text{C}$		12	Amps
		$T_j = 125^\circ\text{C}$		22	

**THERMAL CHARACTERISTICS**

Symbol	Characteristic	MIN	TYP	MAX	UNIT
$R_{\theta JC}$	Junction to Case			0.24	$^\circ\text{C/W}$
$R_{\theta JA}$	Junction to Ambient			40	

- ① Repetitive Rating: Pulse width limited by maximum junction temperature.
- ② Pulse Test: Pulse width < 380  $\mu\text{s}$ , Duty Cycle < 2%
- ③ See MIL-STD-750 Method 3471
- ④ Starting  $T_j = +25^\circ\text{C}$ ,  $L = 870\mu\text{H}$ ,  $R_G = 25\Omega$ , Peak  $I_L = 76\text{A}$
- ⑤  $I_S = -I_D [\text{Cont.}], di/dt = 100A/\mu s, V_{DD} = V_{DSS}, T_j = 150^\circ\text{C}, R_G = 2.0\Omega, V_R = 200V$ .

APT Reserves the right to change, without notice, the specifications and information contained herein.

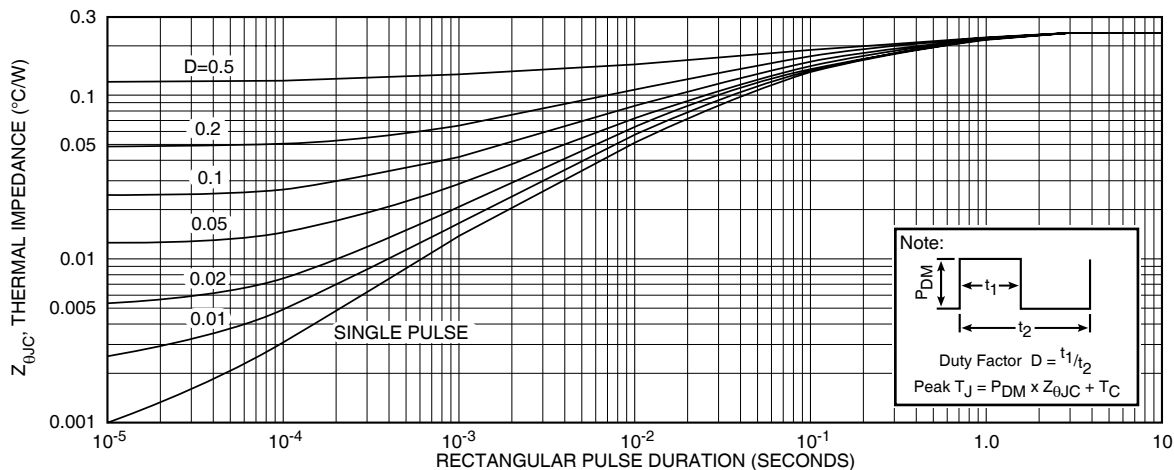

FIGURE 1, MAXIMUM EFFECTIVE TRANSIENT THERMAL IMPEDANCE, JUNCTION-TO-CASE vs PULSE DURATION

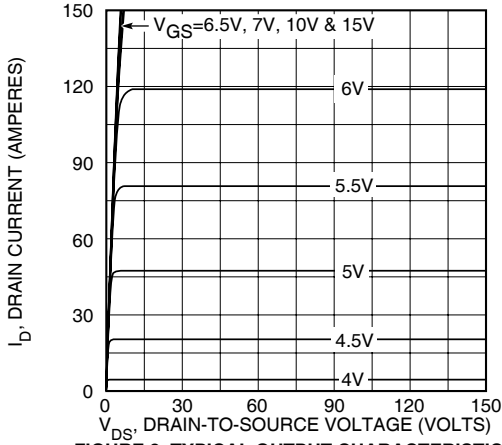

FIGURE 2, TYPICAL OUTPUT CHARACTERISTICS

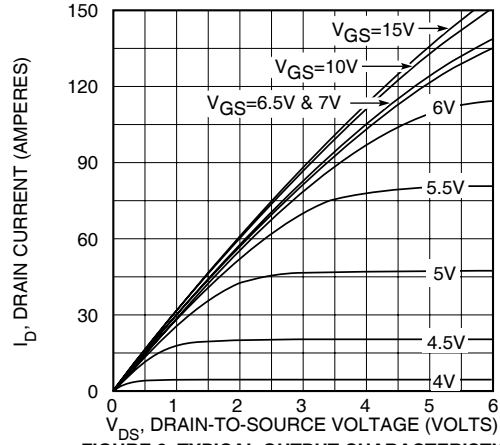

FIGURE 3, TYPICAL OUTPUT CHARACTERISTICS

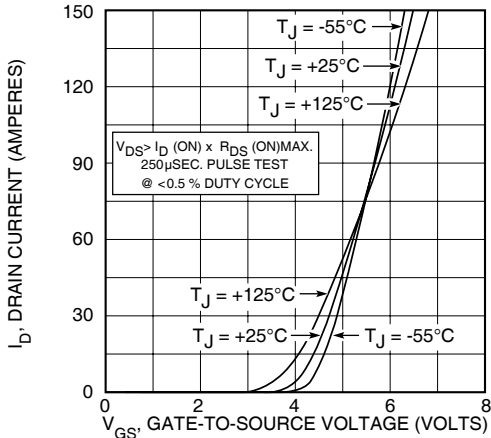

FIGURE 4, TYPICAL TRANSFER CHARACTERISTICS

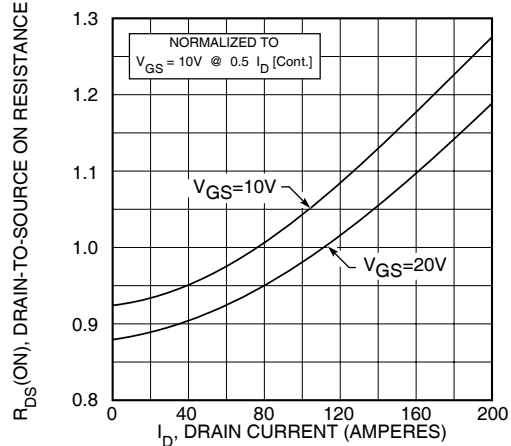

FIGURE 5,  $R_{DS(ON)}$  vs DRAIN CURRENT

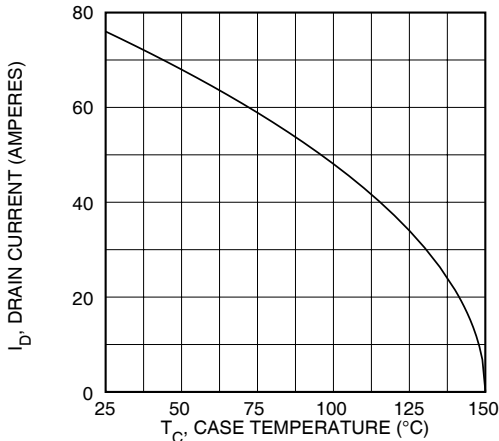

FIGURE 6, MAXIMUM DRAIN CURRENT vs CASE TEMPERATURE

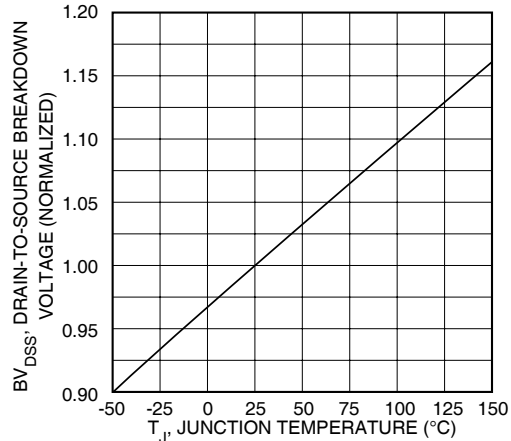

FIGURE 7, BREAKDOWN VOLTAGE vs TEMPERATURE

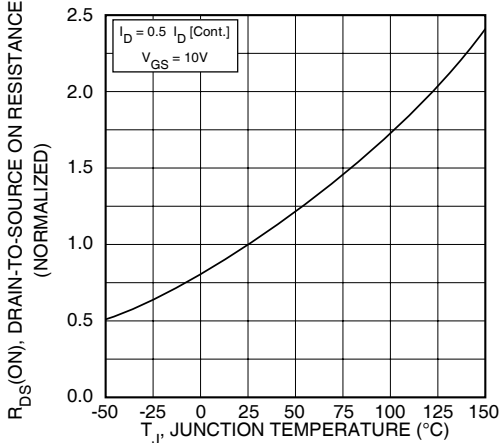

FIGURE 8, ON-RESISTANCE vs. TEMPERATURE

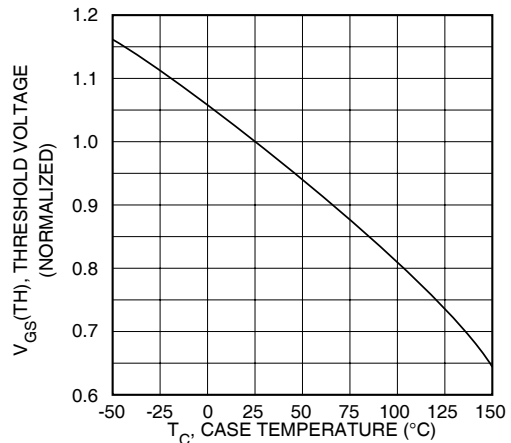

FIGURE 9, THRESHOLD VOLTAGE vs TEMPERATURE

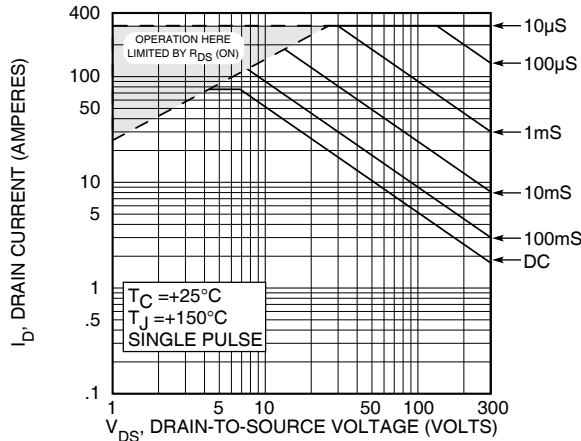

FIGURE 10, MAXIMUM SAFE OPERATING AREA

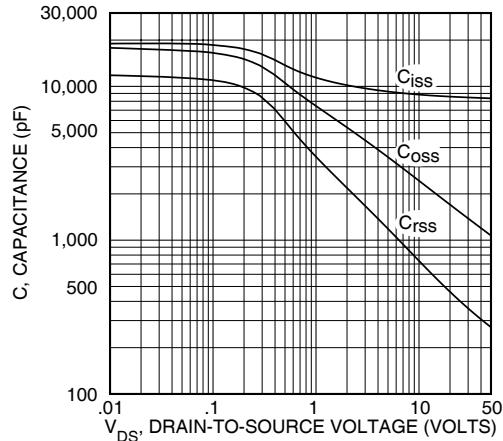

FIGURE 11, TYPICAL CAPACITANCE vs DRAIN-TO-SOURCE VOLTAGE

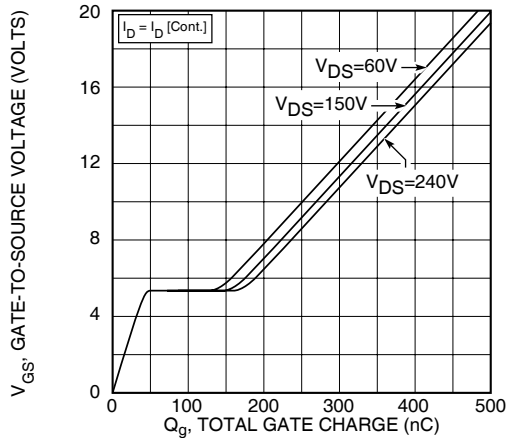

FIGURE 12, GATE CHARGES vs GATE-TO-SOURCE VOLTAGE

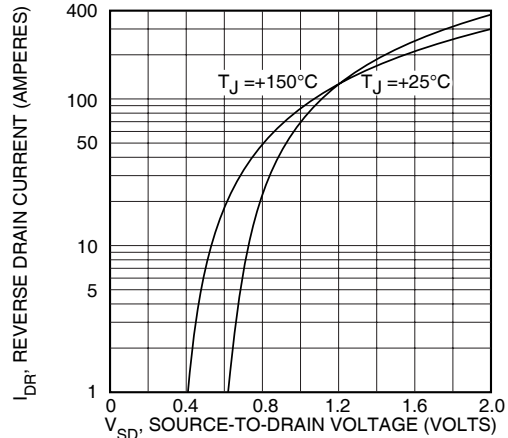
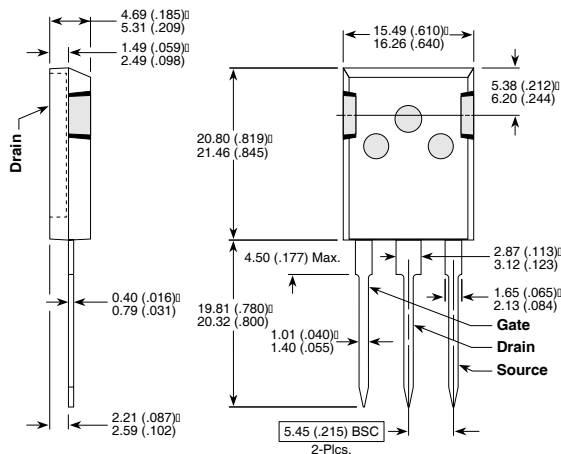

FIGURE 13, TYPICAL SOURCE-DRAIN DIODE FORWARD VOLTAGE

T-MAX™ (B2) Package Outline (B2VFR)



These dimensions are equal to the TO-247 without the mounting hole.  
Dimensions in Millimeters and (Inches)

TO-264 (L) Package Outline (LVFR)

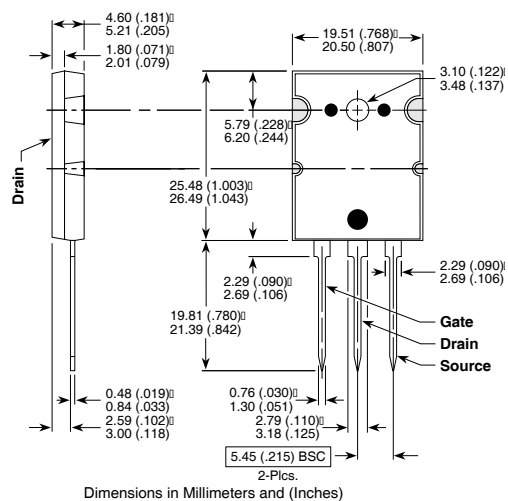

Dimensions in Millimeters and (Inches)