

Cree® XLamp® XHP50.2 LEDs

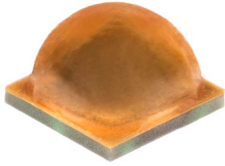

PRODUCT DESCRIPTION

The XLamp XHP50.2 LED is the next generation of Extreme High Power LEDs that delivers the lowest system cost through the best lumen density, reliability and color consistency. Built on Cree's latest high-power LED technology, the XHP50.2 LED improves the lumen density, voltage characteristics, reliability and optical performance of the XHP50 LED in the same 5.0 mm x 5.0 mm footprint. The new XHP50.2 LED provides an easy drop-in upgrade to achieve higher system LPW for lighting manufacturers with existing XHP50 designs, eliminating redesign costs. Its unparalleled lumen density and longer lifetime at higher operating temperatures also enables new and innovative lighting designs at lower system costs.

FEATURES

- Available in white, configurable to 6 V or 12 V by PCB layout
- Available in 5-step EasyWhite® bins at 3000 K to 5000 K CCT, 3-step EasyWhite bins at 2700 K to 5000 K and 2-step EasyWhite bins at 2700 K to 4000 K CCT
- Available in ANSI white bins at 3000 K to 7000 K CCT
- Available in standard, 70-, 80-, and 90-minimum CRI options
- Binned at 85 °C
- Maximum drive current: 3000 mA (6 V), 1500 mA (12 V)
- Low thermal resistance: 1.2 °C/W
- Wide viewing angle: 120°
- Unlimited floor life at ≤ 30 °C/85% RH
- Reflow solderable - JEDEC J-STD-020C
- UL® recognized component (E349212)

TABLE OF CONTENTS

Characteristics	2
Flux Characteristics, EasyWhite® Order Codes and Bins	3
Flux Characteristics, ANSI White Order Codes and Bins	5
Relative Spectral Power Distribution	7
Relative Flux vs. Junction Temperature.....	7
Electrical Characteristics.....	8
Relative Flux vs. Current	9
Relative Chromaticity vs Current.....	10
Relative Chromaticity vs Temperature.....	11
Typical Spatial Distribution.....	11
Thermal Design.....	12
Performance Groups – Luminous Flux.....	13
Performance Groups – Chromaticity.....	13
Cree's EasyWhite® Chromaticity Regions Plotted on the 1931 CIE Curve	16
Cree's ANSI Cool White Kits Plotted on ANSI Standard Chromaticity Regions.....	17
Cree's ANSI Warm and Neutral White Kits Plotted on ANSI Standard Chromaticity Regions.....	18
Bin and Order Code Formats.....	19
Reflow Soldering Characteristics.....	20
Notes	21
Mechanical Dimensions	22
Electrical Configuration	23
Tape and Reel.....	24
Packaging.....	25



CHARACTERISTICS

XHP50.2 LEDs are tested and binned in production in the 12-V configuration. See the Mechanical Dimensions section on page 22 for pad layout options.

Characteristics	Unit	Minimum	Typical	Maximum
Thermal resistance, junction to solder point	°C/W		1.2	
Viewing angle (FWHM)	degrees		120	
Temperature coefficient of voltage (6 V)*	mV/°C		-3	
Temperature coefficient of voltage (12 V)	mV/°C		-6	
ESD withstand voltage (HBM per Mil-Std-883D)	V			8000
DC forward current (6 V)*	mA			3000
DC forward current (12 V)	mA			1500
Reverse voltage	V			5
Forward voltage (6 V, @ 1400 mA, 85 °C)*	V		5.6	6.2
Forward voltage (12 V, @ 700 mA, 85 °C)	V		11.2	12.4
LED junction temperature	°C			150

Note:

* Data for the 6-V configuration is calculated and for reference only.

FLUX CHARACTERISTICS, EASYWHITE® ORDER CODES AND BINS

The following table provides order codes for XLamp XHP50.2 LEDs. For a complete description of how the flux and chromaticity groups are reflected in the bin code and order code nomenclature, please see the Bin and Order Code Formats section (page 19).

Binning condition: $T_j = 85\text{ °C}$; 12 V, $I_f = 700\text{ mA}$

Reference condition: $T_j = 85\text{ °C}$; 6 V, $I_f = 1400\text{ mA}$

Nominal CCT	CRI		Minimum Luminous Flux			2-Step		3-Step		5-Step	
	Min	Typ	Group	Flux (lm) @ 85 °C	Flux (lm) @ 25 °C*	Group	Order Code	Group	Order Code	Group	Order Code
5000 K	70		J4	1120	1239					50E	XHP50B-00-0000-0D0BJ450E
			J2	1040	1151						XHP50B-00-0000-0D0BJ250E
	80		J2	1040	1151			50G	XHP50B-00-0000-0D0HJ250G		
			H4	970	1073				XHP50B-00-0000-0D0HH450G		
	90		H2	900	996			50G	XHP50B-00-0000-0D0UH250G		
			G4	840	930				XHP50B-00-0000-0D0UG450G		
4500 K	70		J4	1120	1239					45E	XHP50B-00-0000-0D0BJ445E
			J2	1040	1151						XHP50B-00-0000-0D0BJ245E
	80		J2	1040	1151			45G	XHP50B-00-0000-0D0HJ245G		
			H4	970	1073				XHP50B-00-0000-0D0HH445G		
	90		H2	900	996			45G	XHP50B-00-0000-0D0UH245G		
			G4	840	930				XHP50B-00-0000-0D0UG445G		
4000 K	70		J4	1120	1239					40E	XHP50B-00-0000-0D0BJ440E
			J2	1040	1151						XHP50B-00-0000-0D0BJ240E
	80		J2	1040	1151	40H	XHP50B-00-0000-0D0HJ240H	40G	XHP50B-00-0000-0D0HJ240G		
			H4	970	1073		XHP50B-00-0000-0D0HH440H		XHP50B-00-0000-0D0HH440G		
	90		H2	900	996	40H	XHP50B-00-0000-0D0UH240H	40G	XHP50B-00-0000-0D0UH240G		
			G4	840	930		XHP50B-00-0000-0D0UG440H		XHP50B-00-0000-0D0UG440G		

Notes

- Cree maintains a tolerance of $\pm 7\%$ on flux and power measurements, ± 0.005 on chromaticity (CCx, CCy) measurements and a tolerance of ± 2 on CRI measurements. See the Measurements section (page 21).
- Cree XLamp XHP50.2 LED order codes specify only a minimum flux bin and not a maximum. Cree may ship reels in flux bins higher than the minimum specified by the order code without advance notice. Shipments will always adhere to the chromaticity bin restrictions specified by the order code.
- * Flux values @ 25 °C are calculated and for reference only.

FLUX CHARACTERISTICS, EASYWHITE® ORDER CODES AND BINS - CONTINUED

Nominal CCT	CRI		Minimum Luminous Flux			2-Step		3-Step		5-Step	
	Min	Typ	Group	Flux (lm) @ 85 °C	Flux (lm) @ 25 °C*	Group	Order Code	Group	Order Code	Group	Order Code
3500 K	70		J4	1120	1239					35E	XHP50B-00-0000-0D0BJ435E
			J2	1040	1151						XHP50B-00-0000-0D0BJ235E
	80		H4	970	1073	35H	XHP50B-00-0000-0D0HH435H	35G	XHP50B-00-0000-0D0HH435G		
			H2	900	996		XHP50B-00-0000-0D0HH235H		XHP50B-00-0000-0D0HH235G		
	90		G4	840	930	35H	XHP50B-00-0000-0D0UG435H	35G	XHP50B-00-0000-0D0UG435G		
			G2	780	863		XHP50B-00-0000-0D0UG235H		XHP50B-00-0000-0D0UG235G		
3000 K	70		J2	1040	1151					30E	XHP50B-00-0000-0D0BJ230E
			H4	970	1073						XHP50B-00-0000-0D0BH430E
	80		H4	970	1073	30H	XHP50B-00-0000-0D0HH430H	30G	XHP50B-00-0000-0D0HH430G		
			H2	900	996		XHP50B-00-0000-0D0HH230H		XHP50B-00-0000-0D0HH230G		
	90		G4	840	930	30H	XHP50B-00-0000-0D0UG430H	30G	XHP50B-00-0000-0D0UG430G		
			G2	780	863		XHP50B-00-0000-0D0UG230H		XHP50B-00-0000-0D0UG230G		
2700 K	80		H2	900	996	27H	XHP50B-00-0000-0D0HH227H	27G	XHP50B-00-0000-0D0HH227G		
			G4	840	930		XHP50B-00-0000-0D0HG427H		XHP50B-00-0000-0D0HG427G		
	90		G2	780	863	27H	XHP50B-00-0000-0D0UG227H	27G	XHP50B-00-0000-0D0UG227G		
			F4	730	808		XHP50B-00-0000-0D0UF427H		XHP50B-00-0000-0D0UF427G		

- Notes**
- Cree maintains a tolerance of ±7% on flux and power measurements, ±0.005 on chromaticity (CCx, CCy) measurements and a tolerance of ±2 on CRI measurements. See the Measurements section (page 21).
 - Cree XLamp XHP50.2 LED order codes specify only a minimum flux bin and not a maximum. Cree may ship reels in flux bins higher than the minimum specified by the order code without advance notice. Shipments will always adhere to the chromaticity bin restrictions specified by the order code.
 - * Flux values @ 25 °C are calculated and for reference only.

FLUX CHARACTERISTICS, ANSI WHITE ORDER CODES AND BINS

The following table provides order codes for XLamp XHP50.2 LEDs. For a complete description of how the flux and chromaticity groups are reflected in the bin code and order code nomenclature, please see the Bin and Order Code Formats section (page 19).

Binning condition: $T_j = 85\text{ °C}$; 12 V, $I_f = 700\text{ mA}$

Reference condition: $T_j = 85\text{ °C}$; 6 V, $I_f = 1400\text{ mA}$

Nominal CCT	Chromaticity Regions	CRI		Minimum Luminous Flux			Order Code
		Min	Typ	Group	Flux (lm) @ 85 °C	Flux (lm) @ 25 °C*	
7000 K	0A, 0B, 0C, 0D, 0R, 0S, 0T, 0U, 1A, 1B, 1C, 1D, 1R, 1S, 1T, 1U	0	68	J4	1120	1239	XHP50B-00-0000-0D00J40DT
				J2	1040	1151	XHP50B-00-0000-0D00J20DT
		70		J4	1120	1239	XHP50B-00-0000-0D0BJ40DT
				J2	1040	1151	XHP50B-00-0000-0D0BJ20DT
		80		J2	1040	1151	XHP50B-00-0000-0D0HJ20DT
				H4	970	1073	XHP50B-00-0000-0D0HH40DT
6500 K	0A, 0B, 0C, 0D, 0R, 0S, 0T, 0U, 1A, 1B, 1C, 1D, 1R, 1S, 1T, 1U, 2A, 2B, 2C, 2D, 2R, 2S, 2T, 2U	0	68	J4	1120	1239	XHP50B-00-0000-0D00J40CB
				J2	1040	1151	XHP50B-00-0000-0D00J20CB
		70		J4	1120	1239	XHP50B-00-0000-0D0BJ40CB
				J2	1040	1151	XHP50B-00-0000-0D0BJ20CB
		80		J2	1040	1151	XHP50B-00-0000-0D0HJ20CB
				H4	970	1073	XHP50B-00-0000-0D0HH40CB
6500 K	1A, 1B, 1C, 1D	0	68	J4	1120	1239	XHP50B-00-0000-0D00J40E1
				J2	1040	1151	XHP50B-00-0000-0D00J20E1
		70		J4	1120	1239	XHP50B-00-0000-0D0BJ40E1
				J2	1040	1151	XHP50B-00-0000-0D0BJ20E1
		80		J2	1040	1151	XHP50B-00-0000-0D0HJ20E1
				H4	970	1073	XHP50B-00-0000-0D0HH40E1
6000 K	1A, 1B, 1C, 1D, 1R, 1S, 1T, 1U, 2A, 2B, 2C, 2D, 2R, 2S, 2T, 2U	0	68	J4	1120	1239	XHP50B-00-0000-0D00J40DV
				J2	1040	1151	XHP50B-00-0000-0D00J20DV
		70		J4	1120	1239	XHP50B-00-0000-0D0BJ40DV
				J2	1040	1151	XHP50B-00-0000-0D0BJ20DV
		80		J2	1040	1151	XHP50B-00-0000-0D0HJ20DV
				H4	970	1073	XHP50B-00-0000-0D0HH40DV
		90		H2	900	996	XHP50B-00-0000-0D0UH20DV
				G4	840	930	XHP50B-00-0000-0D0UG40DV

Notes

- Cree maintains a tolerance of $\pm 7\%$ on flux and power measurements, ± 0.005 on chromaticity (CCx, CCy) measurements and a tolerance of ± 2 on CRI measurements. See the Measurements section (page 21).
- Cree XLamp XHP50.2 LED order codes specify only a minimum flux bin and not a maximum. Cree may ship reels in flux bins higher than the minimum specified by the order code without advance notice. Shipments will always adhere to the chromaticity bin restrictions specified by the order code.
- * Flux values @ 25 °C are calculated and for reference only.

FLUX CHARACTERISTICS, ANSI WHITE ORDER CODES AND BINS - CONTINUED

Nominal CCT	Chromaticity Regions	CRI		Minimum Luminous Flux			Order Code		
		Min	Typ	Group	Flux (lm) @ 85 °C	Flux (lm) @ 25 °C*			
5700 K	2A, 2B, 2C, 2D	0	68	J4	1120	1239	XHP50B-00-0000-0D00J40E2		
				J2	1040	1151	XHP50B-00-0000-0D00J20E2		
		70		J4	1120	1239	XHP50B-00-0000-0D0BJ40E2		
				J2	1040	1151	XHP50B-00-0000-0D0BJ20E2		
		80		J2	1040	1151	XHP50B-00-0000-0D0HJ20E2		
				H4	970	1073	XHP50B-00-0000-0D0HH40E2		
		90		H2	900	996	XHP50B-00-0000-0D0UH20E2		
				G4	840	930	XHP50B-00-0000-0D0UG40E2		
		5000 K	3A, 3B, 3C, 3D	0	68	K2	1200	1328	XHP50B-00-0000-0D00K20E3
						J4	1120	1239	XHP50B-00-0000-0D00J40E3
J2	1040					1151	XHP50A-00-0000-0D00J20E3		
70				J4	1120	1239	XHP50B-00-0000-0D0BJ40E3		
				J2	1040	1151	XHP50B-00-0000-0D0BJ20E3		
80				J2	1040	1151	XHP50B-00-0000-0D0HJ20E3		
				H4	970	1073	XHP50B-00-0000-0D0HH40E3		
90				H2	900	996	XHP50B-00-0000-0D0UH20E3		
				G4	840	930	XHP50B-00-0000-0D0UG40E3		
4500 K	4A, 4B, 4C, 4D			0	68	J4	1120	1239	XHP50B-00-0000-0D00J40E4
		J2	1040			1151	XHP50B-00-0000-0D00J20E4		
		70		J4	1120	1239	XHP50B-00-0000-0D0BJ40E4		
				J2	1040	1151	XHP50B-00-0000-0D0BJ20E4		
		80		J2	1040	1151	XHP50B-00-0000-0D0HJ20E4		
				H4	970	1073	XHP50B-00-0000-0D0HH40E4		
		90		H2	900	996	XHP50B-00-0000-0D0UH20E4		
				G4	840	930	XHP50B-00-0000-0D0UG40E4		
		4000 K	5A, 5B, 5C, 5D	0	68	J4	1120	1239	XHP50B-00-0000-0D00J40E5
						J2	1040	1151	XHP50B-00-0000-0D00J20E5
70				J4	1120	1239	XHP50B-00-0000-0D0BJ40E5		
				J2	1040	1151	XHP50B-00-0000-0D0BJ20E5		
80				H4	970	1073	XHP50B-00-0000-0D0HH40E5		
				H2	900	996	XHP50B-00-0000-0D0HH20E5		
90				H2	900	996	XHP50B-00-0000-0D0UH20E5		
				G4	840	930	XHP50B-00-0000-0D0UG40E5		
3500 K	6A, 6B, 6C, 6D			70		J4	1120	1239	XHP50B-00-0000-0D0BJ40E6
						J2	1040	1151	XHP50B-00-0000-0D0BJ20E6
3000 K	7A, 7B, 7C, 7D	70		J2	1040	1151	XHP50B-00-0000-0D0BJ20E7		
				H4	970	1073	XHP50B-00-0000-0D0BH40E7		

- Notes**
- Cree maintains a tolerance of ±7% on flux and power measurements, ±0.005 on chromaticity (CCx, CCy) measurements and a tolerance of ±2 on CRI measurements. See the Measurements section (page 21).
 - Cree XLamp XHP50.2 LED order codes specify only a minimum flux bin and not a maximum. Cree may ship reels in flux bins higher than the minimum specified by the order code without advance notice. Shipments will always adhere to the chromaticity bin restrictions specified by the order code.
 - * Flux values @ 25 °C are calculated and for reference only.

RELATIVE SPECTRAL POWER DISTRIBUTION

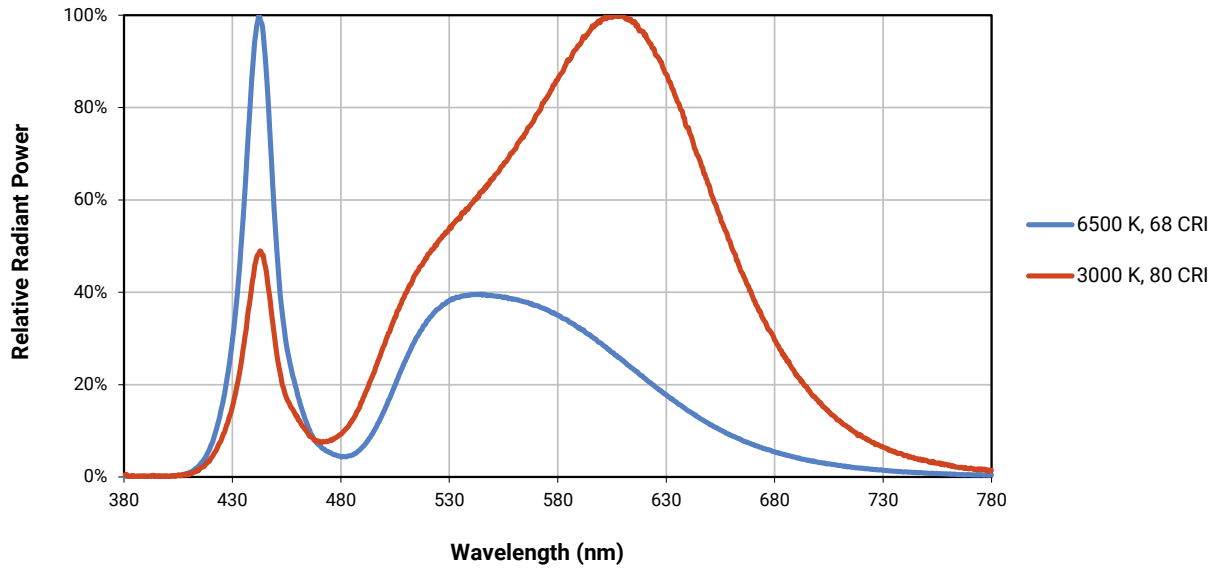

RELATIVE FLUX VS. JUNCTION TEMPERATURE

Reference condition: 6 V, $I_F = 1400$ mA; 12 V, $I_F = 700$ mA

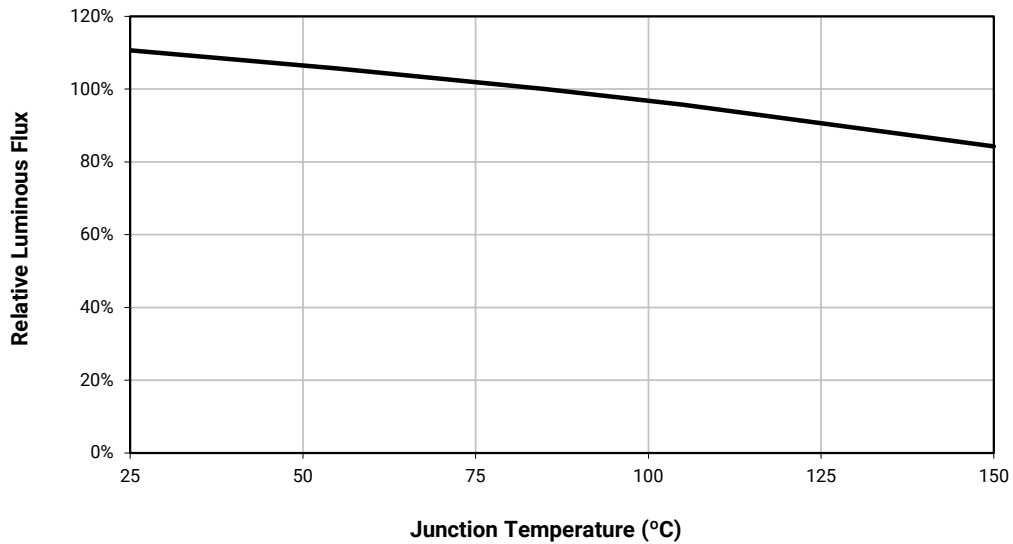

ELECTRICAL CHARACTERISTICS ($T_j = 85^\circ\text{C}$)

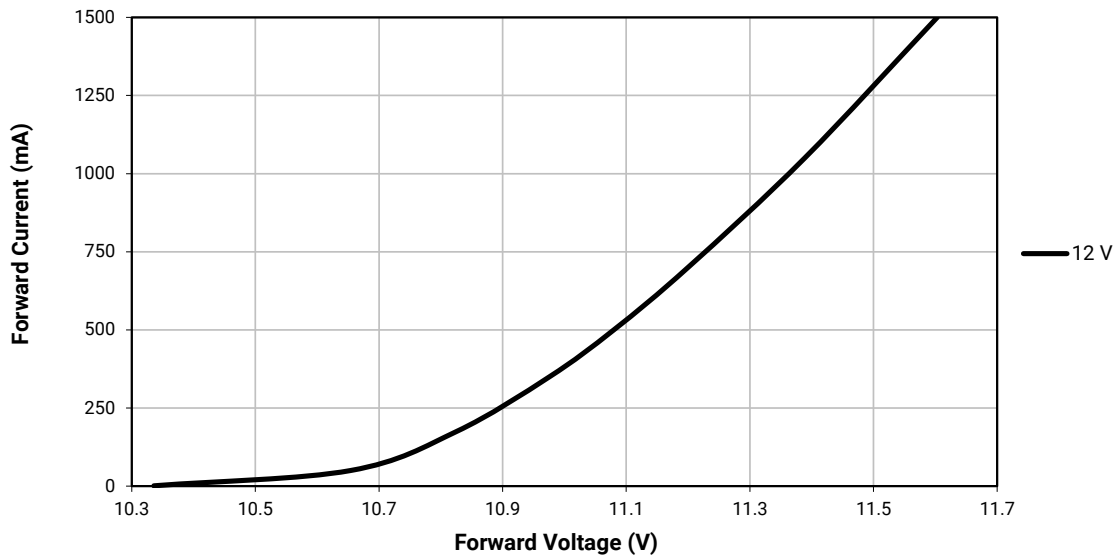
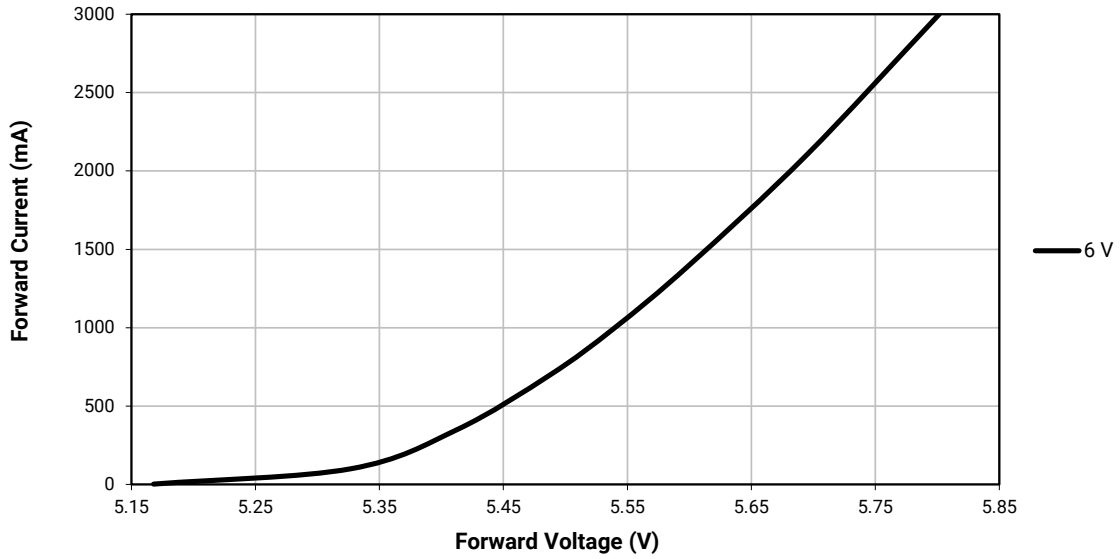

RELATIVE FLUX VS. CURRENT ($T_j = 85\text{ }^\circ\text{C}$)

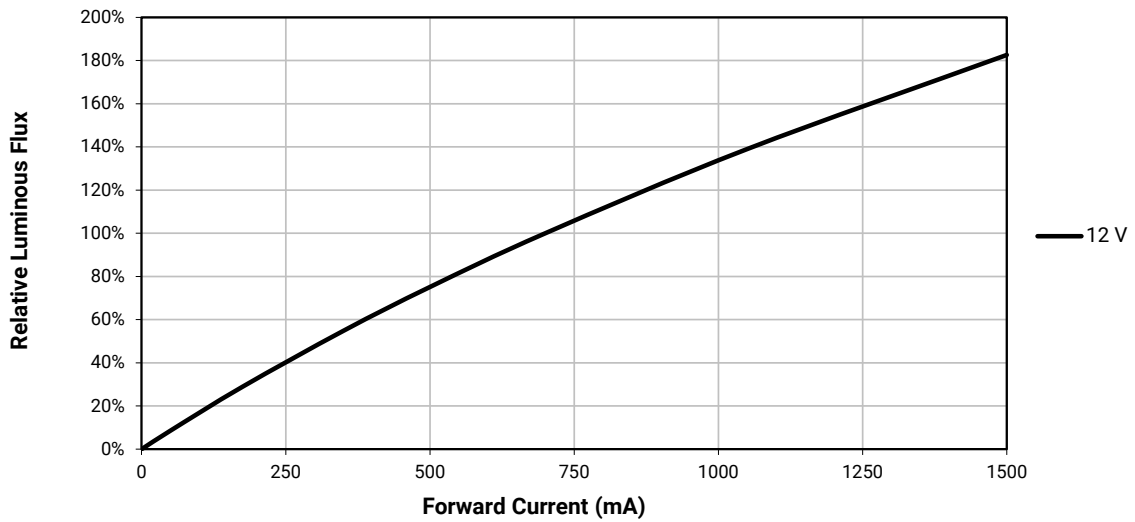
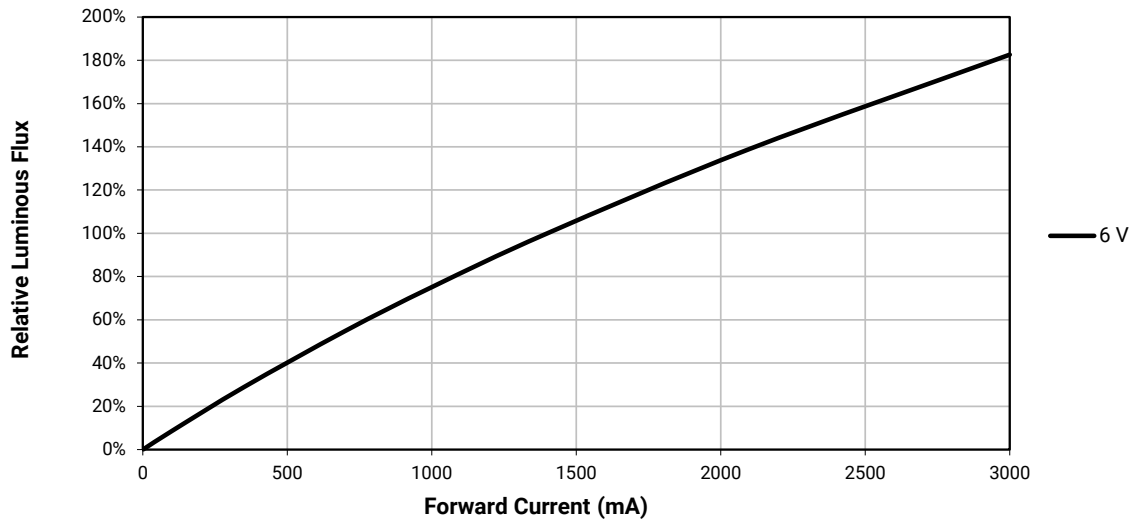

RELATIVE CHROMATICITY VS CURRENT (WARM WHITE)

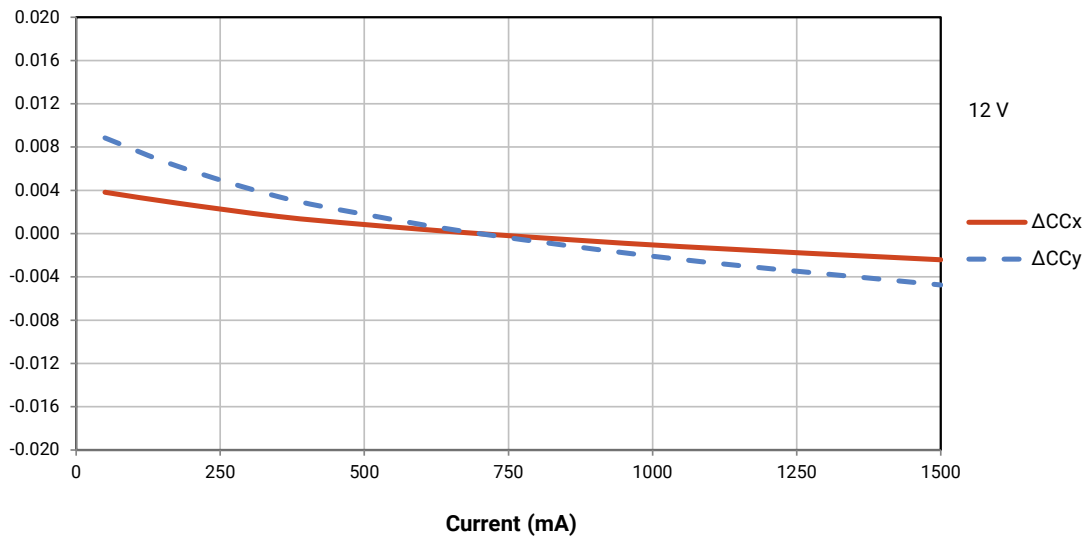
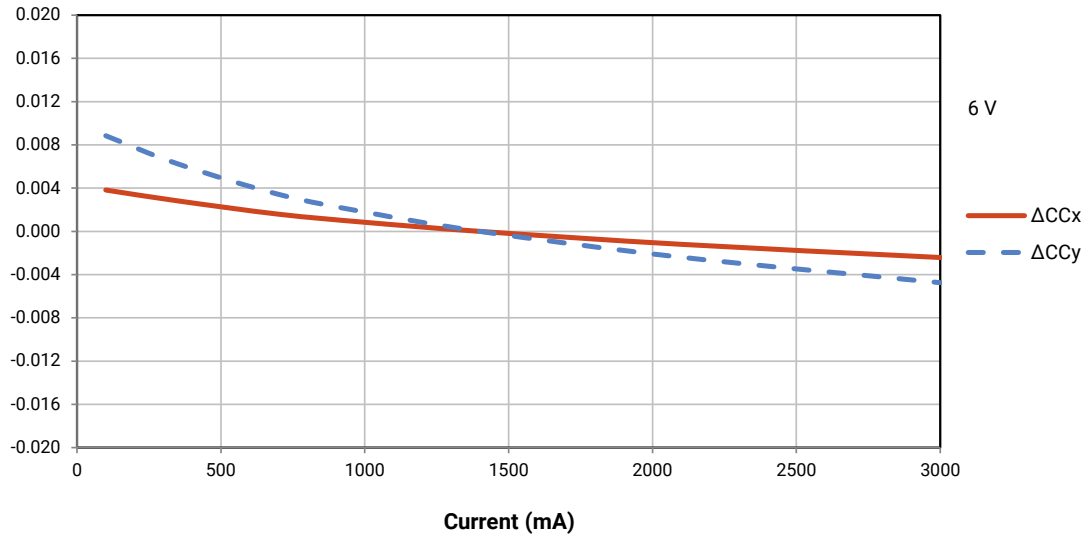

RELATIVE CHROMATICITY VS TEMPERATURE (WARM WHITE)

Reference condition: 6 V, $I_F = 1400$ mA; 12 V, $I_F = 700$ mA

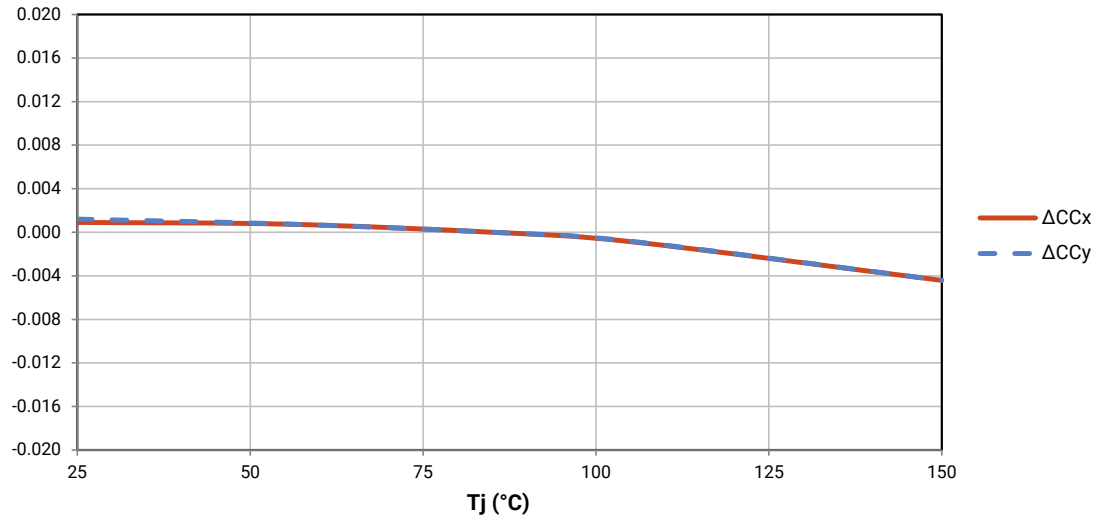

TYPICAL SPATIAL DISTRIBUTION

Reference condition: $T_J = 85$ °C; 6 V, $I_F = 1400$ mA; 12 V, $I_F = 700$ mA

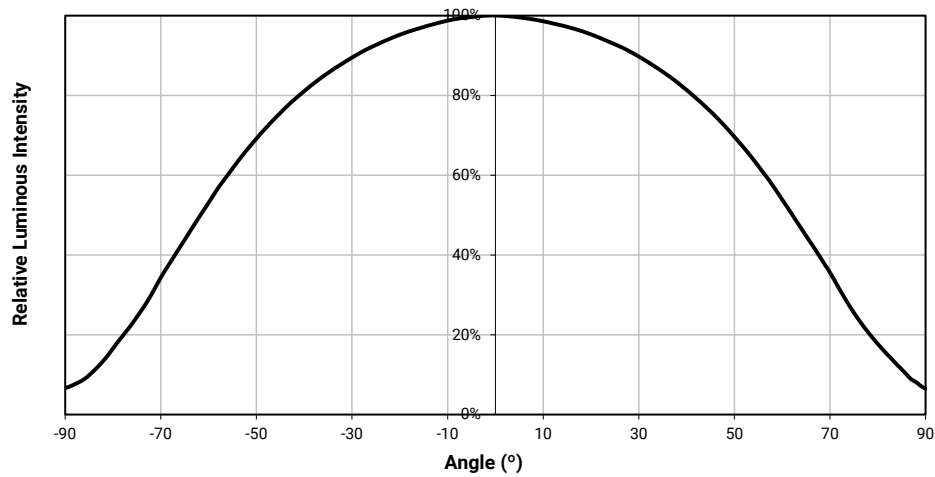

THERMAL DESIGN

The maximum forward current is determined by the thermal resistance between the LED junction and ambient. It is crucial for the end product to be designed in a manner that minimizes the thermal resistance from the solder point to ambient in order to optimize lamp life and optical characteristics.

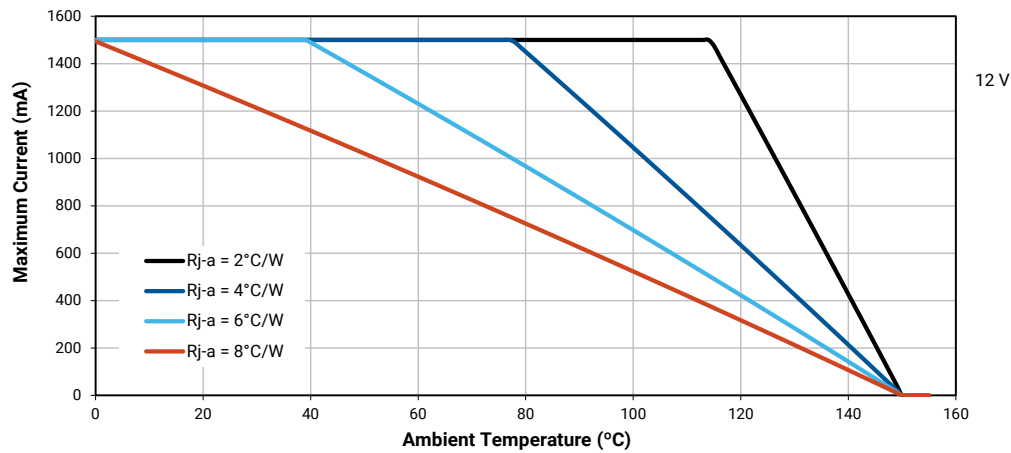
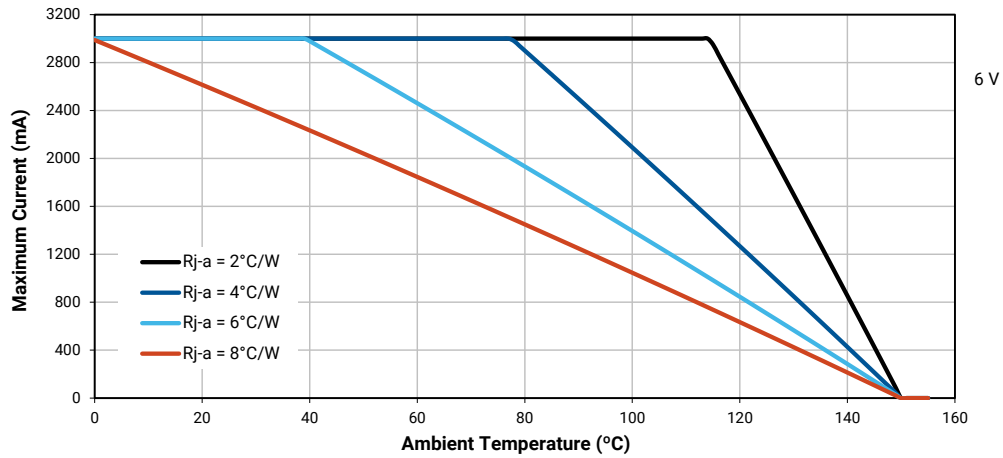

PERFORMANCE GROUPS – LUMINOUS FLUX ($T_j = 85\text{ }^\circ\text{C}$)

XLamp XHP50.2 LEDs are tested for luminous flux and placed into one of the following luminous-flux groups.

Group Code	Minimum Luminous Flux	Maximum Luminous Flux
F4	730	780
G2	780	840
G4	840	900
H2	900	970
H4	970	1040
J2	1040	1120
J4	1120	1200
K2	1200	1290
K4	1290	1380

PERFORMANCE GROUPS – CHROMATICITY

XLamp XHP50.2 LEDs are tested for chromaticity and placed into one of the regions defined by the following bounding coordinates.

EasyWhite Color Temperatures – 2-Step			
Bin Code	CCT	x	y
40H	4000 K	0.3777	0.3739
		0.3797	0.3816
		0.3861	0.3855
		0.3838	0.3777
35H	3500 K	0.4022	0.3858
		0.4053	0.3942
		0.4125	0.3977
		0.4091	0.3891
30H	3000 K	0.4287	0.3975
		0.4328	0.4064
		0.4390	0.4086
		0.4347	0.3996
27H	2700 K	0.4524	0.4048
		0.4574	0.4140
		0.4633	0.4154
		0.4581	0.4062

PERFORMANCE GROUPS – CHROMATICITY (CONTINUED)

EasyWhite Color Temperatures – 3-Step Ellipse						
Bin Code	CCT	Center Point		Major Axis	Minor Axis	Rotation Angle (°)
		x	y	a	b	
50G	5000 K	0.3447	0.3553	0.00840	0.00312	65.0
45G	4500 K	0.3611	0.3658	0.00852	0.00330	61.5
40G	4000 K	0.3818	0.3797	0.00939	0.00402	53.7
35G	3500 K	0.4073	0.3917	0.00927	0.00414	54.0
30G	3000 K	0.4338	0.4030	0.00834	0.00408	53.2
27G	2700 K	0.4577	0.4099	0.00834	0.00420	48.5

EasyWhite Color Temperatures – 5-Step Ellipse						
Bin Code	CCT	Center Point		Major Axis	Minor Axis	Rotation Angle (°)
		x	y	a	b	
50E	5000 K	0.3447	0.3553	0.01400	0.00520	65.0
45E	4500 K	0.3611	0.3658	0.01420	0.00550	61.5
40E	4000 K	0.3818	0.3797	0.01565	0.00670	53.7
35E	3500 K	0.4073	0.3917	0.01545	0.00690	54.0
30E	3000 K	0.4338	0.4030	0.01390	0.00680	53.2

ANSI White Bins			
CCT	Bin Code	x	y
7000 K	0A0	0.2950	0.2970
		0.2920	0.3060
		0.2984	0.3133
		0.3009	0.3042
	0B0	0.2920	0.3060
		0.2895	0.3135
		0.2962	0.3220
		0.2984	0.3133
	0C0	0.2984	0.3133
		0.2962	0.3220
		0.3028	0.3304
		0.3048	0.3207
	0D0	0.2984	0.3133
		0.3048	0.3207
		0.3068	0.3113
		0.3009	0.3042

ANSI White Bins			
CCT	Bin Code	x	y
7000 K	0R0	0.2980	0.2880
		0.2950	0.2970
		0.3009	0.3042
		0.3037	0.2937
	0S0	0.2895	0.3135
		0.2870	0.3210
		0.2937	0.3312
		0.2962	0.3220
	0T0	0.2962	0.3220
		0.2937	0.3312
		0.3005	0.3415
		0.3028	0.3304
	0U0	0.3037	0.2937
		0.3009	0.3042
		0.3068	0.3113
		0.3093	0.2993

ANSI White Bins			
CCT	Bin Code	x	y
7000 K	1A0	0.3048	0.3207
		0.3130	0.3290
		0.3144	0.3186
		0.3068	0.3113
	1B0	0.3028	0.3304
		0.3115	0.3391
		0.3130	0.3290
		0.3048	0.3207
	1C0	0.3115	0.3391
		0.3205	0.3481
		0.3213	0.3373
		0.3130	0.3290
	1D0	0.3130	0.3290
		0.3213	0.3373
		0.3221	0.3261
		0.3144	0.3186

PERFORMANCE GROUPS – CHROMATICITY (CONTINUED)

ANSI White Bins			
CCT	Bin Code	x	y
7000 K	1R0	0.3068	0.3113
		0.3144	0.3186
		0.3161	0.3059
		0.3093	0.2993
	1S0	0.3005	0.3415
		0.3099	0.3509
		0.3115	0.3391
		0.3028	0.3304
	1T0	0.3099	0.3509
		0.3196	0.3602
		0.3205	0.3481
		0.3115	0.3391
	1U0	0.3144	0.3186
		0.3221	0.3261
		0.3231	0.3120
		0.3161	0.3059

ANSI White Bins			
CCT	Bin Code	x	y
6000 K	2A0	0.3215	0.3350
		0.3290	0.3417
		0.3290	0.3300
		0.3222	0.3243
	2B0	0.3207	0.3462
		0.3290	0.3538
		0.3290	0.3417
		0.3215	0.3350
	2C0	0.3290	0.3538
		0.3376	0.3616
		0.3371	0.3490
		0.3290	0.3417
	2D0	0.3290	0.3417
		0.3371	0.3490
		0.3366	0.3369
		0.3290	0.3300

ANSI White Bins			
CCT	Bin Code	x	y
6000 K	2R0	0.3222	0.3243
		0.3290	0.3300
		0.3290	0.3180
		0.3231	0.3120
	2S0	0.3196	0.3602
		0.3290	0.3690
		0.3290	0.3538
		0.3207	0.3462
	2T0	0.3290	0.3690
		0.3381	0.3762
		0.3376	0.3616
		0.3290	0.3538
	2U0	0.3290	0.3300
		0.3366	0.3369
		0.3361	0.3245
		0.3290	0.3180

ANSI White Bins			
CCT	Bin Code	x	y
5000 K	3A0	0.3371	0.3490
		0.3451	0.3554
		0.3440	0.3427
		0.3366	0.3369
	3B0	0.3376	0.3616
		0.3463	0.3687
		0.3451	0.3554
		0.3371	0.3490
	3C0	0.3463	0.3687
		0.3551	0.3760
		0.3533	0.3620
		0.3451	0.3554
	3D0	0.3451	0.3554
		0.3533	0.3620
		0.3515	0.3487
		0.3440	0.3427

ANSI White Bins			
CCT	Bin Code	x	y
4500 K	4A0	0.3530	0.3597
		0.3615	0.3659
		0.3512	0.3465
		0.3515	0.3487
	4B0	0.3548	0.3736
		0.3641	0.3804
		0.3530	0.3597
		0.3533	0.362
	4C0	0.3641	0.3804
		0.3736	0.3874
		0.3702	0.3722
		0.3615	0.3659
	4D0	0.3615	0.3659
		0.3702	0.3722
		0.3670	0.3578
		0.3590	0.3521

PERFORMANCE GROUPS – CHROMATICITY (CONTINUED)

ANSI White Bins			
CCT	Bin Code	x	y
4000 K	5A0	0.3670	0.3578
		0.3702	0.3722
		0.3825	0.3798
		0.3783	0.3646
	5B0	0.3702	0.3722
		0.3736	0.3874
		0.3869	0.3958
		0.3825	0.3798
	5C0	0.3825	0.3798
		0.3869	0.3958
		0.4006	0.4044
		0.3950	0.3875
	5D0	0.3783	0.3646
		0.3825	0.3798
		0.3950	0.3875
		0.3898	0.3716

ANSI White Bins			
CCT	Bin Code	x	y
3500 K	6A0	0.3889	0.3690
		0.3941	0.3848
		0.4080	0.3916
		0.4017	0.3751
	6B0	0.3941	0.3848
		0.3996	0.4015
		0.4146	0.4089
		0.4080	0.3916
	6C0	0.4080	0.3916
		0.4146	0.4089
		0.4299	0.4165
		0.4221	0.3984
	6D0	0.4017	0.3751
		0.4080	0.3916
		0.4221	0.3984
		0.4147	0.3814

ANSI White Bins			
CCT	Bin Code	x	y
3000 K	7A0	0.4147	0.3814
		0.4221	0.3984
		0.4342	0.4028
		0.4259	0.3853
	7B0	0.4221	0.3984
		0.4299	0.4165
		0.4430	0.4212
		0.4342	0.4028
	7C0	0.4342	0.4028
		0.4430	0.4212
		0.4562	0.4260
		0.4465	0.4071
	7D0	0.4259	0.3853
		0.4342	0.4028
		0.4465	0.4071
		0.4373	0.3893

CREE'S EASYWHITE® CHROMATICITY REGIONS PLOTTED ON THE 1931 CIE CURVE

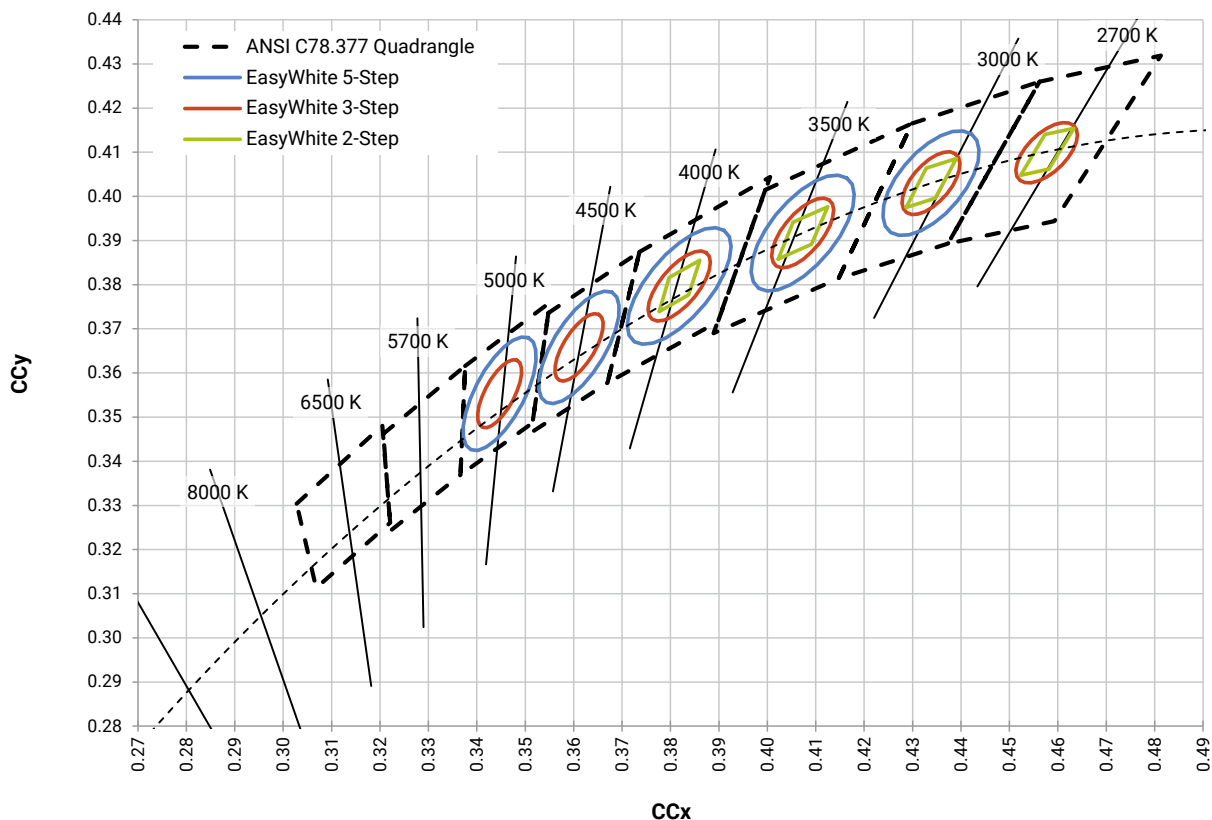

CREE'S ANSI COOL WHITE KITS PLOTTED ON ANSI STANDARD CHROMATICITY REGIONS

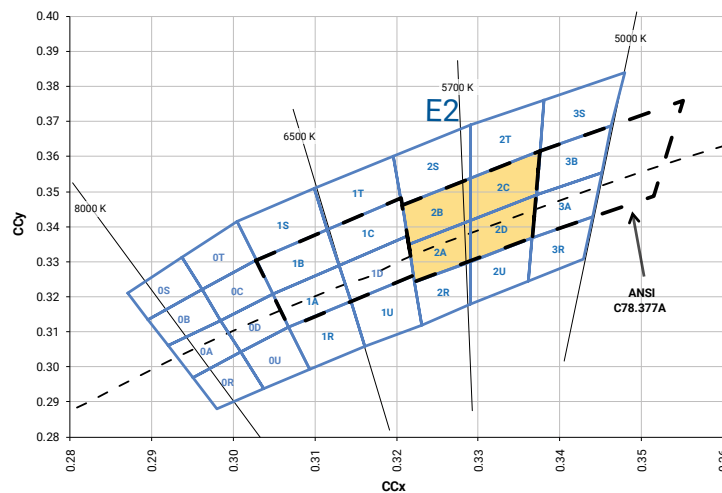
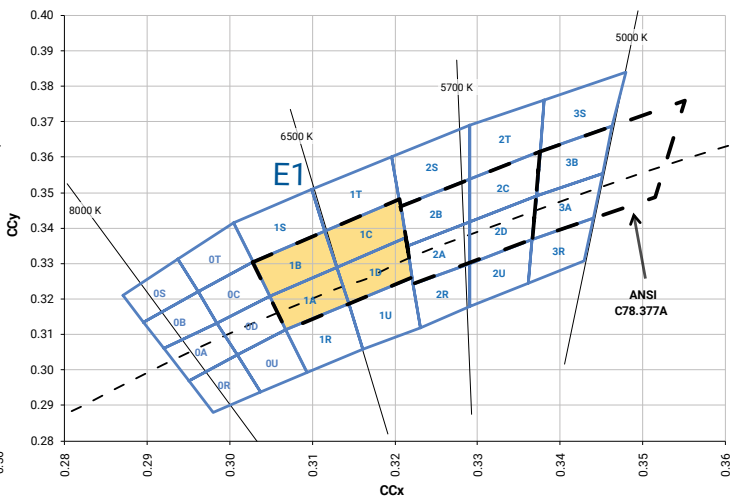
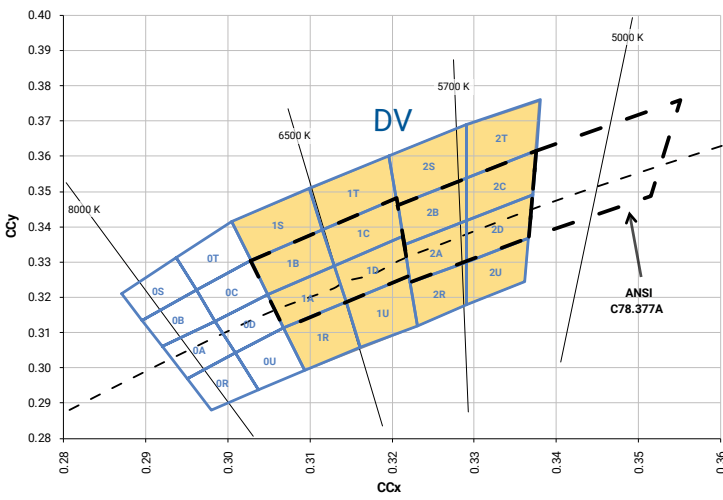
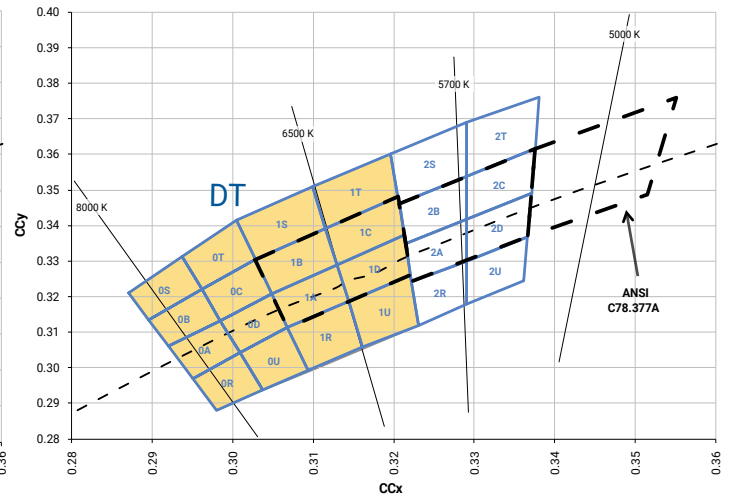
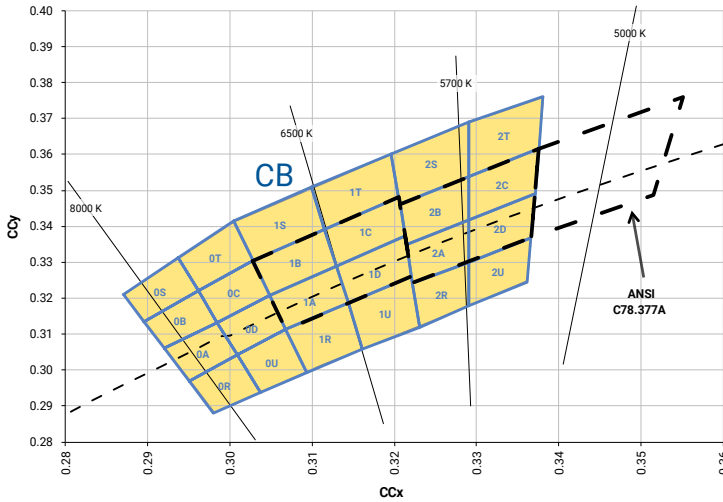

CREE'S ANSI WARM AND NEUTRAL WHITE KITS PLOTTED ON ANSI STANDARD CHROMATICITY REGIONS

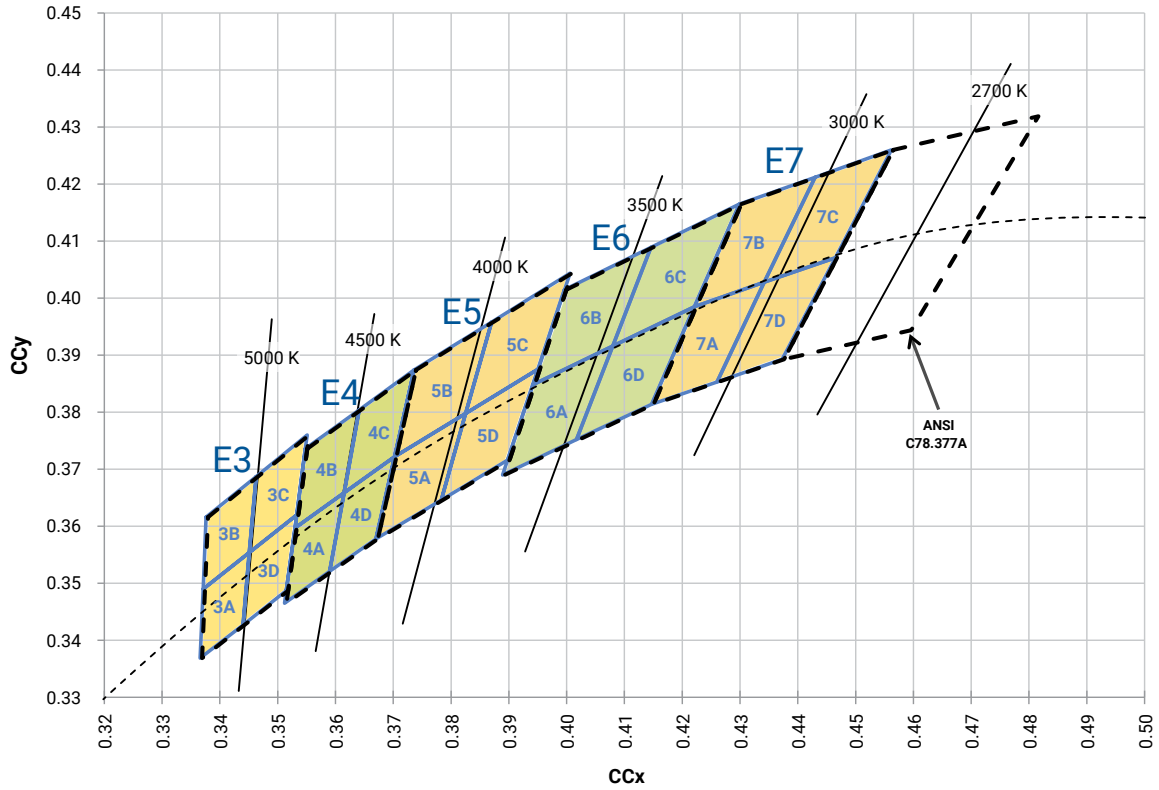

BIN AND ORDER CODE FORMATS

Bin codes and order codes for XHP50.2 LEDs are configured in the following manner:

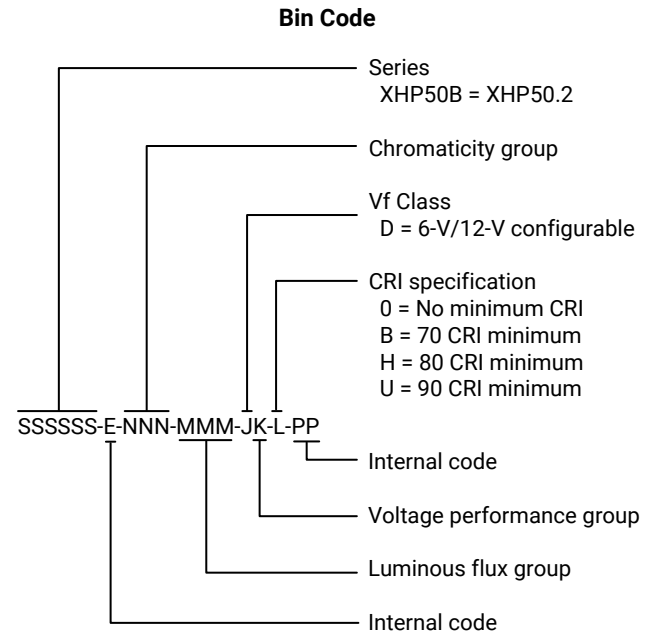
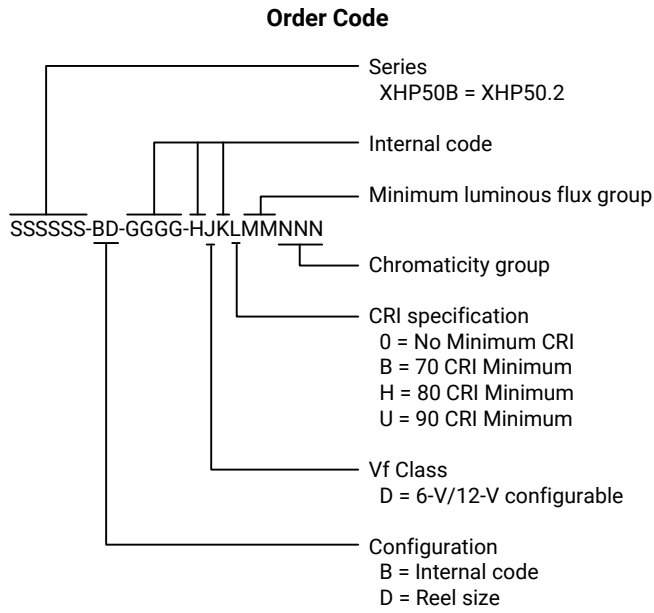

REFLOW SOLDERING CHARACTERISTICS

In testing, Cree has found XLamp XHP50.2 LEDs to be compatible with JEDEC J-STD-020C, using the parameters listed below. As a general guideline, Cree recommends that users follow the recommended soldering profile provided by the manufacturer of the solder paste used.

Note that this general guideline may not apply to all PCB designs and configurations of reflow soldering equipment.



IPC/JEDEC J-STD-020C

Profile Feature	Lead-Free Solder
Average Ramp-Up Rate ($T_{s_{max}}$ to T_P)	1.2 °C/second
Preheat: Temperature Min ($T_{s_{min}}$)	120 °C
Preheat: Temperature Max ($T_{s_{max}}$)	170 °C
Preheat: Time ($t_{s_{min}}$ to $t_{s_{max}}$)	65-150 seconds
Time Maintained Above: Temperature (T_L)	217 °C
Time Maintained Above: Time (t_l)	45-90 seconds
Peak/Classification Temperature (T_P)	235 - 245 °C
Time Within 5 °C of Actual Peak Temperature (t_p)	20-40 seconds
Ramp-Down Rate	1 - 6 °C/second
Time 25 °C to Peak Temperature	4 minutes max.

Note: All temperatures refer to the topside of the package, measured on the package body surface.

NOTES

Measurements

The luminous flux, radiant power, chromaticity and CRI measurements in this document are binning specifications only and solely represent product measurements as of the date of shipment. These measurements will change over time based on a number of factors that are not within Cree's control and are not intended or provided as operational specifications for the products. Calculated values are provided for informational purposes only and are not intended as specifications.

Pre-Release Qualification Testing

Please read the [LED Reliability Overview](#) for details of the qualification process Cree applies to ensure long-term reliability for XLamp LEDs and details of Cree's pre-release qualification testing for XLamp LEDs. Cree did not perform Room Temperature Operating Life (RTOL) testing on the XHP50.2 LED.

Lumen Maintenance

Cree now uses standardized IES LM-80-08 and TM-21-11 methods for collecting long-term data and extrapolating LED lumen maintenance. For information on the specific LM-80 data sets available for this LED, refer to the public [LM-80 results document](#).

Please read the [Long-Term Lumen Maintenance application note](#) for more details on Cree's lumen maintenance testing and forecasting. Please read the [Thermal Management application note](#) for details on how thermal design, ambient temperature, and drive current affect the LED junction temperature.

Moisture Sensitivity

Cree recommends keeping XLamp LEDs in the provided, resealable moisture-barrier packaging (MBP) until immediately prior to soldering. Unopened MBPs that contain XLamp LEDs do not need special storage for moisture sensitivity.

Once the MBP is opened, XLamp XHP50.2 LEDs may be stored as MSL 1 per JEDEC J-STD-033, meaning they have unlimited floor life in conditions of ≤ 30 °C/85% relative humidity (RH). Regardless of the storage condition, Cree recommends sealing any unsoldered LEDs in the original MBP.

UL® Recognized Component

Level 4 enclosure consideration. The LED package or a portion thereof has been investigated as a fire and electrical enclosure per ANSI/UL 8750.

Vision Advisory

WARNING: Do not look at exposed lamp in operation. Eye injury can result. For more information about LEDs and eye safety, please refer to the [LED Eye Safety application note](#).

MECHANICAL DIMENSIONS

Thermal vias, if present, are not shown on these drawings.

All dimensions are $\pm .13$ mm unless otherwise indicated.

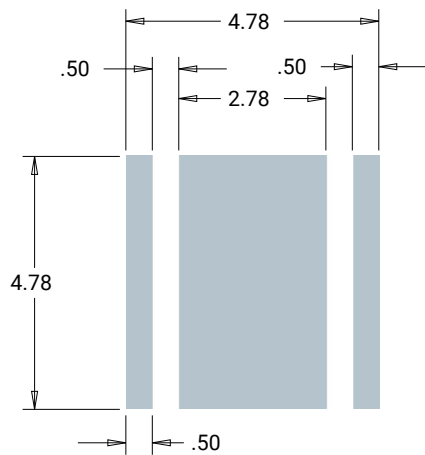
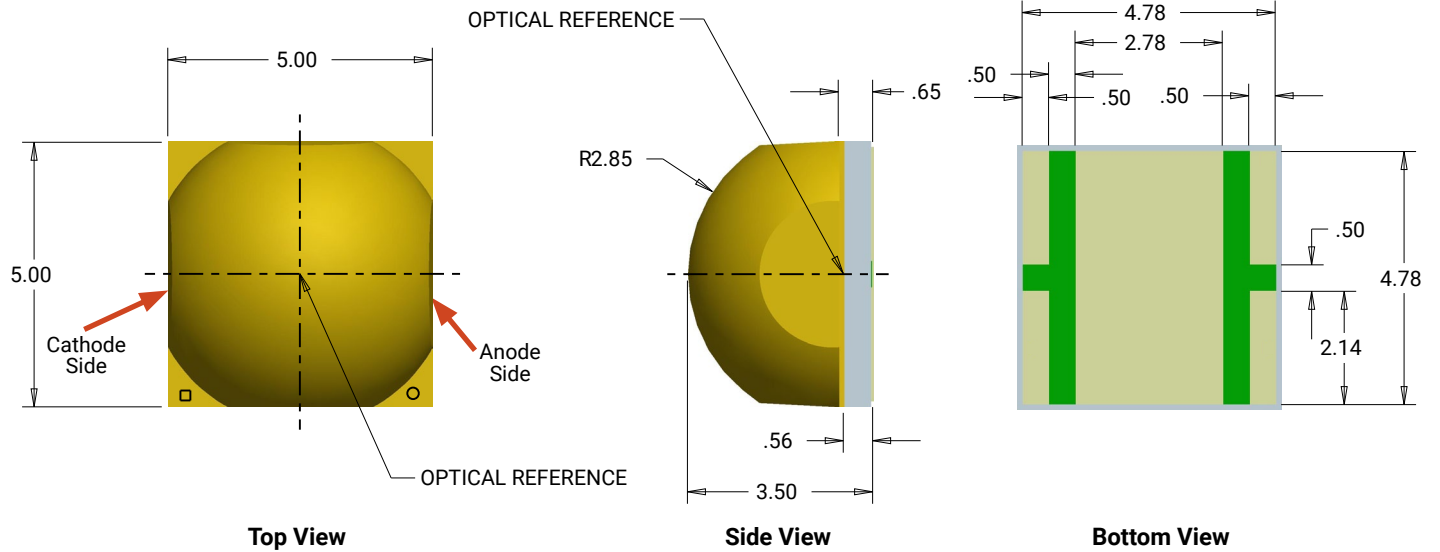

**Recommended PCB Solder Pad
6 V Configuration
(thermal pad is electrically isolated)**

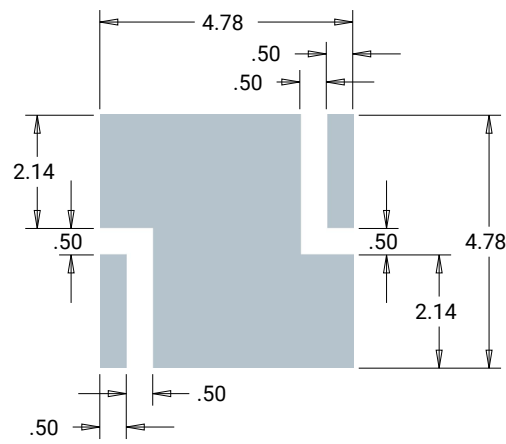

**Recommended PCB Solder Pad
12 V Configuration
(thermal pad is connected to anode and cathode
and is not electrically isolated)**

MECHANICAL DIMENSIONS - CONTINUED

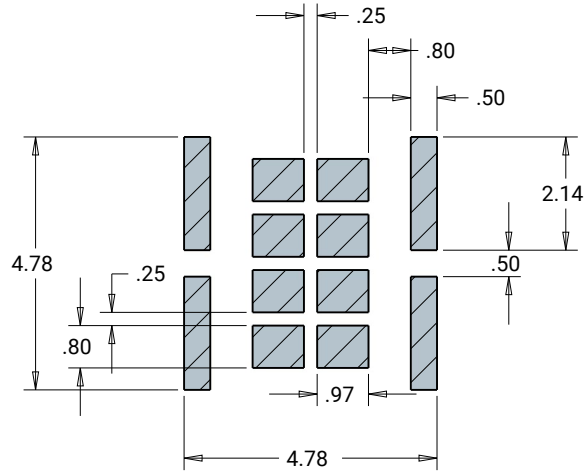

**Recommended Stencil Pattern
6 V & 12 V Configurations
(shaded area is open)**

ELECTRICAL CONFIGURATION

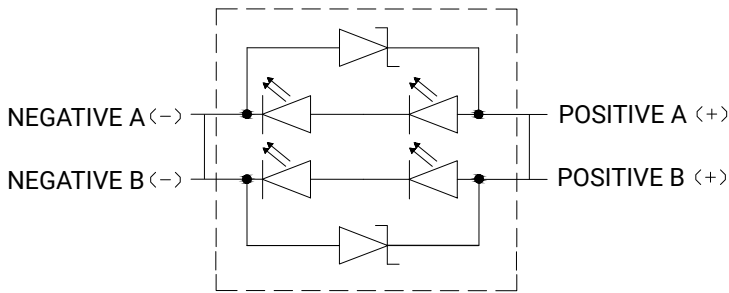

6-V Configuration

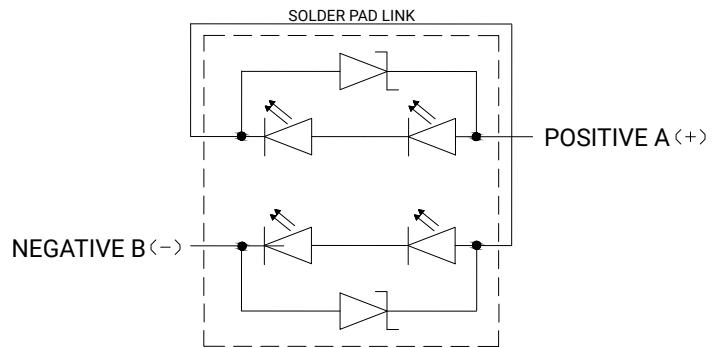

12-V Configuration

TAPE AND REEL

All Cree carrier tapes conform to EIA-481D, Automated Component Handling Systems Standard.

All dimensions are ±.13 mm unless otherwise indicated.

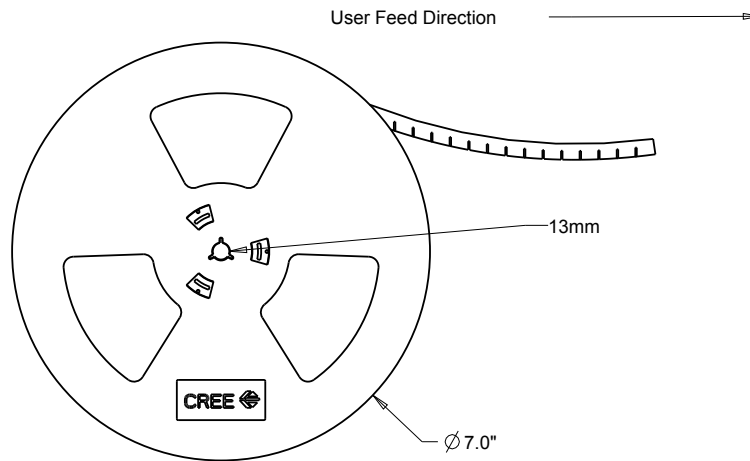
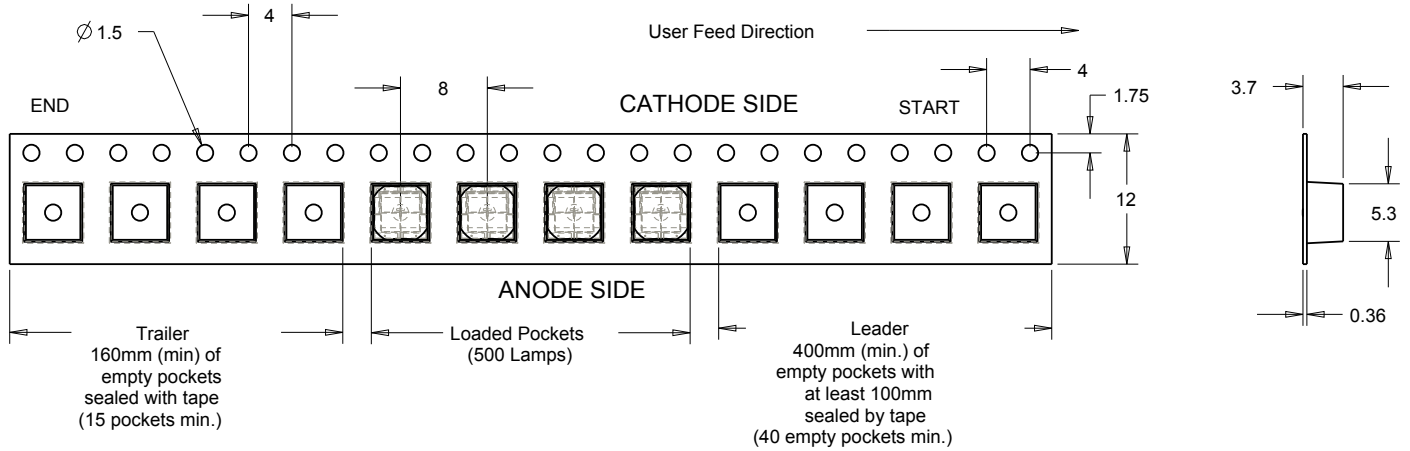

PACKAGING

Unpackaged Reel

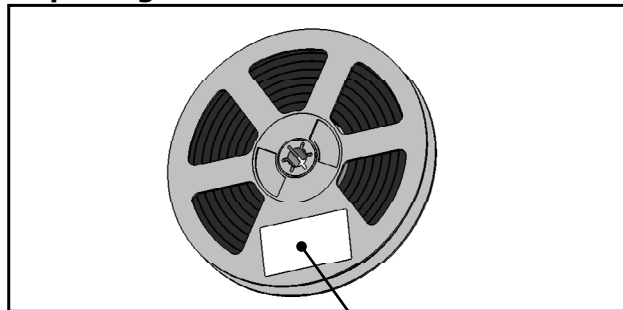

Label with Cree Bin Code,
Quantity, Reel ID

Packaged Reel

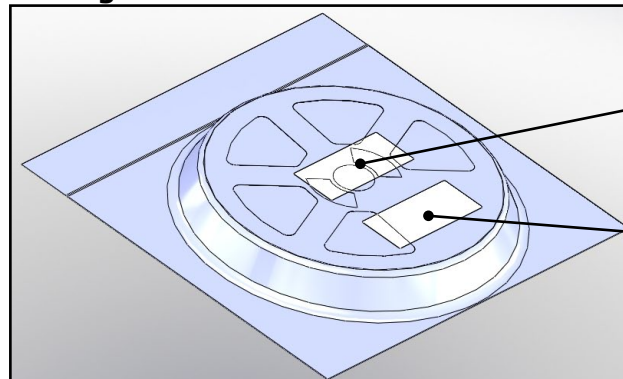

Label with Cree Order Code,
Quantity, Reel ID, PO #

Label with Cree Bin Code,
Quantity, Reel ID

Boxed Reel

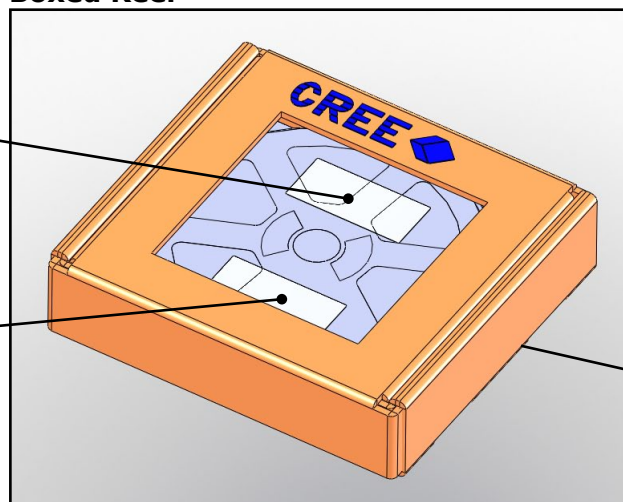

Label with Cree Order Code,
Quantity, Reel ID, PO #

Label with Cree Bin Code,
Quantity, Reel ID

Patent Label
(on bottom of box)