

SDD1&0NXXB

Diode-Diode Modules



Type	V _{RSM} V	V _{RRM} V
SDD120N08B	900	800
SDD120N12B	1300	1200
SDD120N14B	1500	1400
SDD120N16B	1700	1600
SDD120N18B	1900	1800
SDD120N20B	2100	2000
SDD120N22B	2300	2200

Holerance: ±0.5mm
Dimensions in mm (1mm=0.0394")

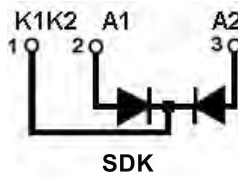
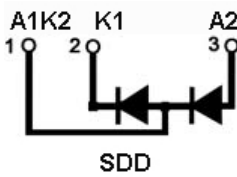
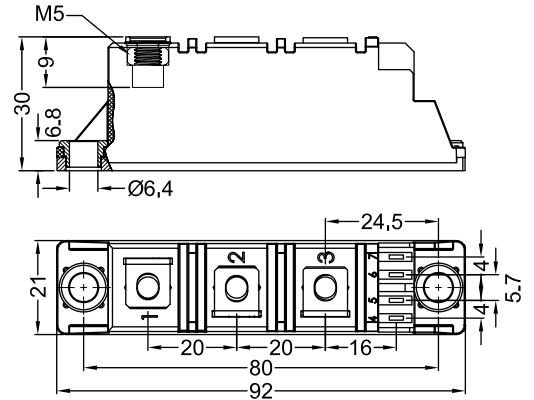

Symbol	Test Conditions	Maximum Ratings	Unit
I _{FRMS} I _{FAVM}	T _{VJ} =T _{VJM} T _C =100°C; 180° sine	188 120	A
I _{FSM}	T _{VJ} =45°C V _R =0 t=10ms (50Hz), sine t=8.3ms (60Hz), sine	2800 3300	A
	T _{VJ} =T _{VJM} V _R =0 t=10ms(50Hz), sine t=8.3ms(60Hz), sine	2500 2750	
∫i ² dt	T _{VJ} =45°C V _R =0 t=10ms (50Hz), sine t=8.3ms (60Hz), sine	39200 45000	A ² s
	T _{VJ} =T _{VJM} V _R =0 t=10ms(50Hz), sine t=8.3ms(60Hz), sine	31200 31300	
T _{VJ} T _{VJM} T _{stg}		-40...+150 150 -40...+125	°C
V _{ISOL}	50/60Hz, RMS I _{ISOL} ≤1mA t=1min t=1s	3000 3600	V~
M _d	Mounting torque (M5) Terminal connection torque (M5)	2.5-4/22-35 2.5-4/22-35	Nm/lb.in.
Weight	Typ.	105	g

Sirectifier[®]

www.sirectifier.com

SDD1&0NXXB

Diode-Diode Modules

Symbol	Test Conditions	Characteristic Values	Unit
I_R	T _{VJ} =T _{VJM} ; V _R =V _{RRM}	15	mA
V_F	I _F =360A; T _{VJ} =25°C	1.63	V
V_{To}	For power-loss calculations only	0.75	V
r_T	T _{VJ} =T _{VJM}	1.95	Ω
Q_s	T _{VJ} =125°C; I _F =50A; -di/dt=3A/us	170	uC
I_{RM}		45	A
R_{thJC}	per diode; DC current per module	0.30 0.145	K/W
R_{thJK}	per diode; DC current per module	0.50 0.245	K/W
ds	Creepage distance on surface	12.7	mm
dA	Strike distance through air	9.6	mm
a	Maximum allowable acceleration	50	m/s ²

FEATURES

- * International standard package
- * Copper base plate
- * Glass passivated chips
- * Isolation voltage 3600 V~
- * UL file NO.310749
- * RoHs compliant

APPLICATIONS

- * Supplies for DC power equipment
- * DC supply for PWM inverter
- * Field supply for DC motors
- * Battery DC power supplies

ADVANTAGES

- * Space and weight savings
- * Simple mounting
- * Improved temperature and power cycling
- * Reduced protection circuits

Sirectifier[®]

www.sirectifier.com

SDD120NXXB

Diode-Diode Modules

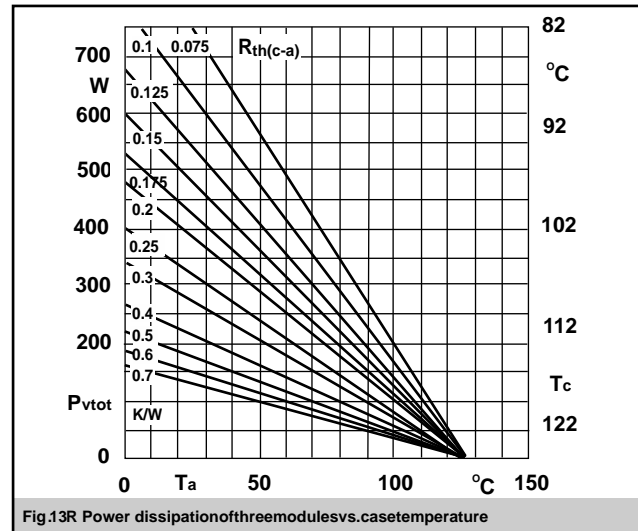
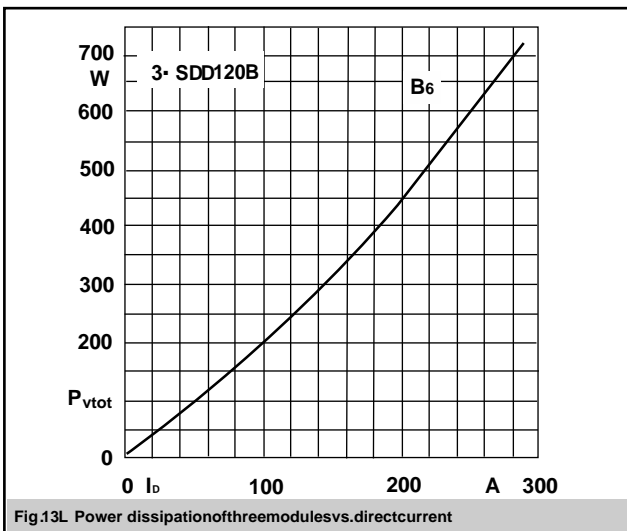
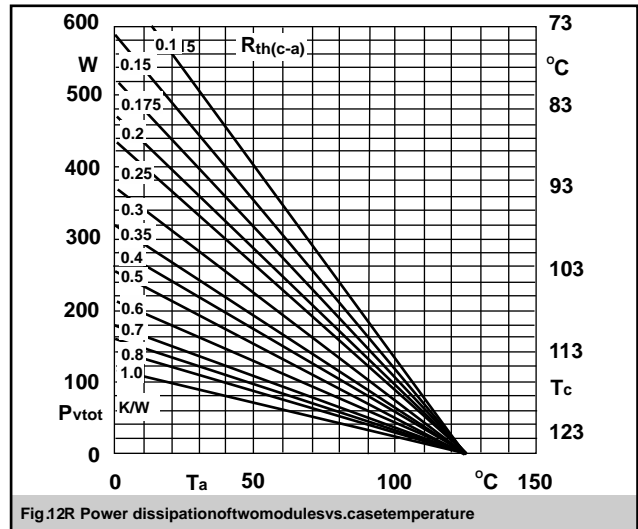
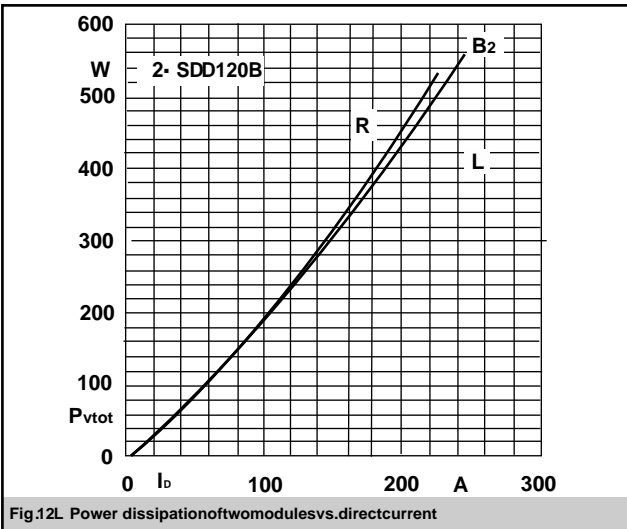
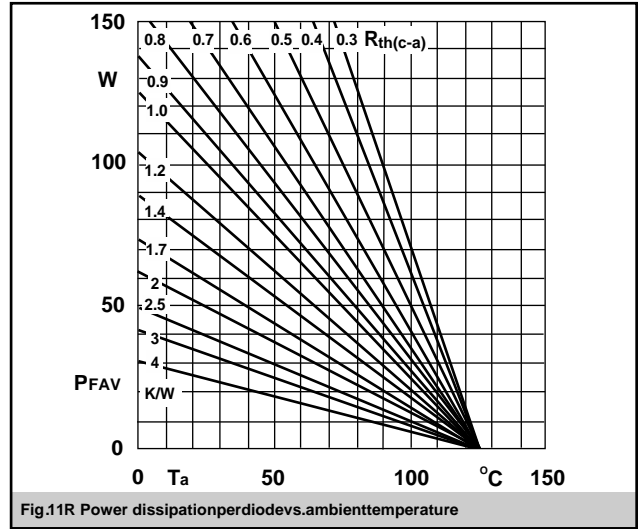
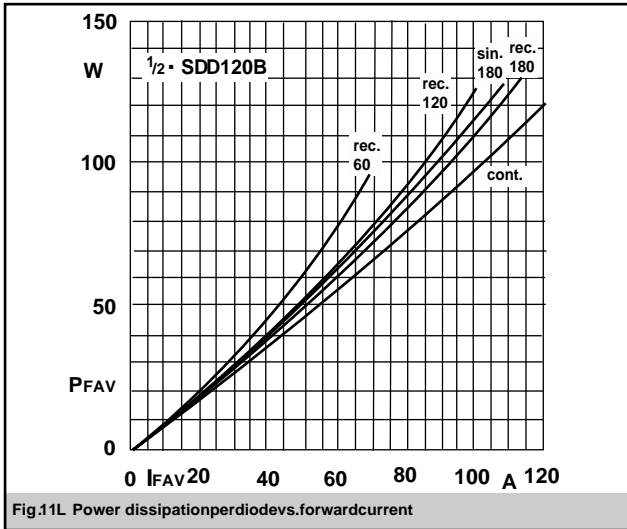

SDD1&0NXXB

Diode-Diode Modules

