



DATA SHEET

SEMICONDUCTOR

MMBT2907ADW

TRANSISTOR (PNP)

FEATURE

Complementary NPN Type available MMBT2222ADW

MAXIMUM RATINGS (T_A=25°C unless otherwise noted)

Symbol	Parameter	Value	Units
V _{CB0}	Collector-Base Voltage	-60	V
V _{CEO}	Collector-Emitter Voltage	-60	V
V _{EBO}	Emitter-Base Voltage	-5	V
I _C	Collector Current -Continuous	-600	mA
P _C	Collector Power Dissipation	200	mW
T _J	Junction Temperature	150	°C
T _{stg}	Storage Temperature	-55-150	°C

MARKING: 2F

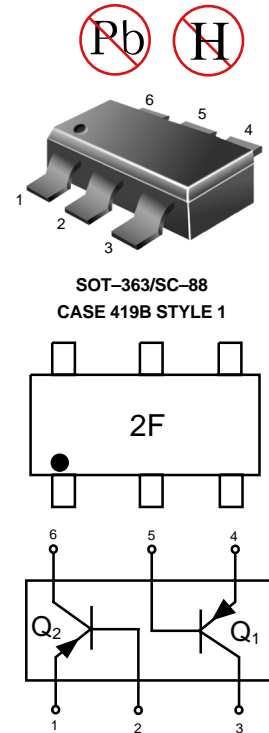

ELECTRICAL CHARACTERISTICS (T_{amb}=25°C unless otherwise specified)

Parameter	Symbol	Test conditions	MIN	MAX	UNIT
Collector-base breakdown voltage	V _{(BR)CBO}	I _C = -10μA, I _E =0	-60		V
Collector-emitter breakdown voltage	V _{(BR)CEO}	I _C = -10mA, I _B =0	-60		V
Emitter-base breakdown voltage	V _{(BR)EBO}	I _E =-10μA, I _C =0	-5		V
Collector cut-off current	I _{CBO}	V _{CB} =-50V, I _E =0		-10	nA
Collector cut-off current	I _{CEX}	V _{CE} =-30V, V _{EB(Off)} =-0.5V		-50	nA
Emitter cut-off current	I _{EBO}	V _{EB} =-5V, I _C =0		-10	nA
DC current gain	h _{FE(1)}	V _{CE} =-10V, I _C = -0.1mA	75		
	h _{FE(2)}	V _{CE} =-10V, I _C = -1mA	100		
	h _{FE(3)}	V _{CE} =-10V, I _C =-10mA	100		
	h _{FE(4)}	V _{CE} =-10V, I _C = -150mA	100	300	
	h _{FE(5)}	V _{CE} =-10V, I _C =-500mA	50		
Collector-emitter saturation voltage	V _{CE(sat)1}	I _C =-150mA, I _B =-15mA		-0.4	V
	V _{CE(sat)2}	I _C =-500mA, I _B =- 50mA		-1.6	V
Base-emitter saturation voltage	V _{BE(sat)1}	I _C =-150mA, I _B =-15mA		-1.3	V
	V _{BE(sat)2}	I _C =-500mA, I _B =- 50mA		-2.6	V
Transition frequency	f _T	V _{CE} =-20V, I _C = -50mA, f=100MHz	200		MHz
Output Capacitance	C _{ob}	V _{CB} =-10V, I _E = 0, f=1MHz		8	pF
Input Capacitance	C _{ib}	V _{EB} =-2V, I _C = 0, f=1MHz		30	pF
Delay time	t _d	V _{CC} =-30V, I _C =-150mA, I _{B1} =-15mA		10	nS
Rise time	t _r		40	nS	
Storage time	t _S	V _{CC} =-6V, I _C =-150mA,		225	nS
Fall time	t _f	I _{B1} = I _{B2} = -15mA		60	nS

DEVICE CHARACTERISTICS

MMBT2907ADW

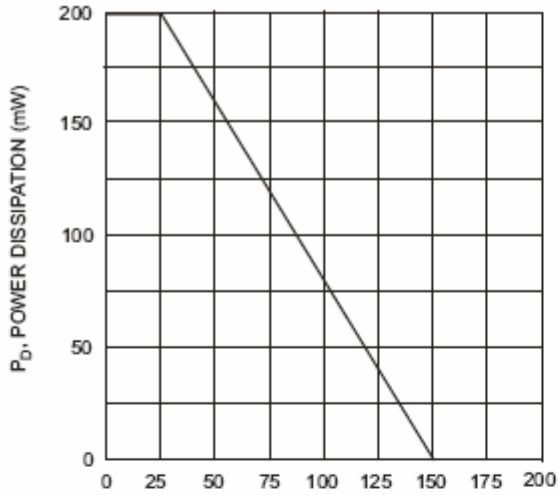

T_A, AMBIENT TEMPERATURE (°C)

Fig. 1, Max Power Dissipation vs Ambient Temperature

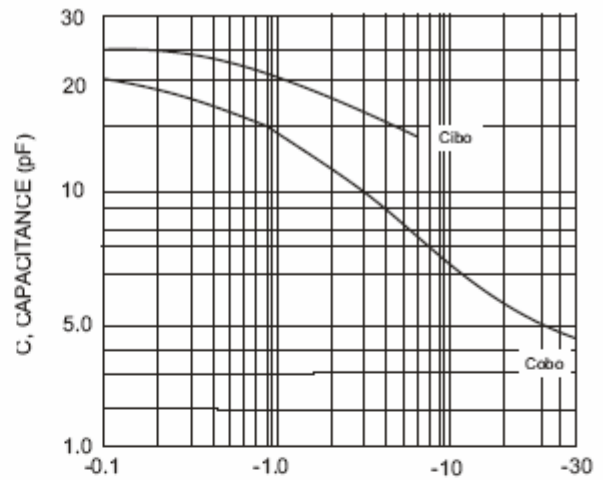

REVERSE VOLTS (V)
Fig. 2 Typical Capacitance

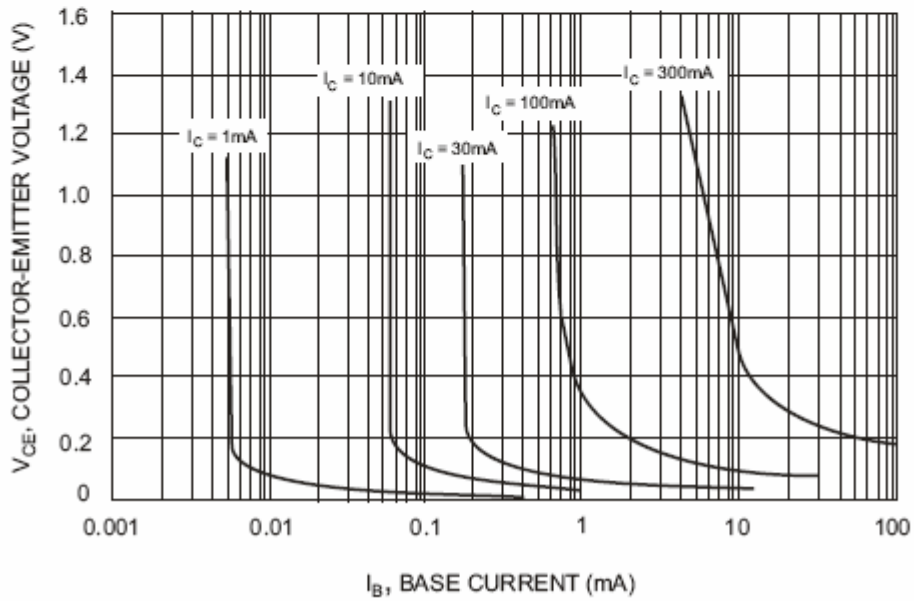

I_B, BASE CURRENT (mA)

Fig. 3 Typical Collector Saturation Region

DEVICE CHARACTERISTICS

MMBT2907ADW

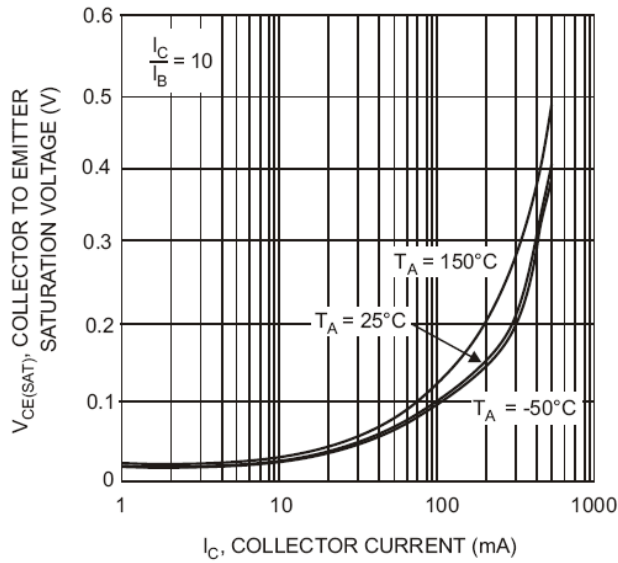

Fig. 4, Collector Emitter Saturation Voltage vs. Collector Current

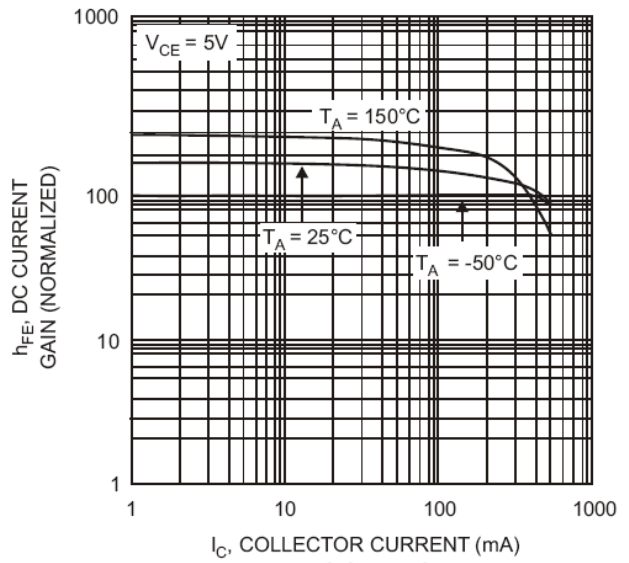

Fig. 5, DC Current Gain vs. Collector Current

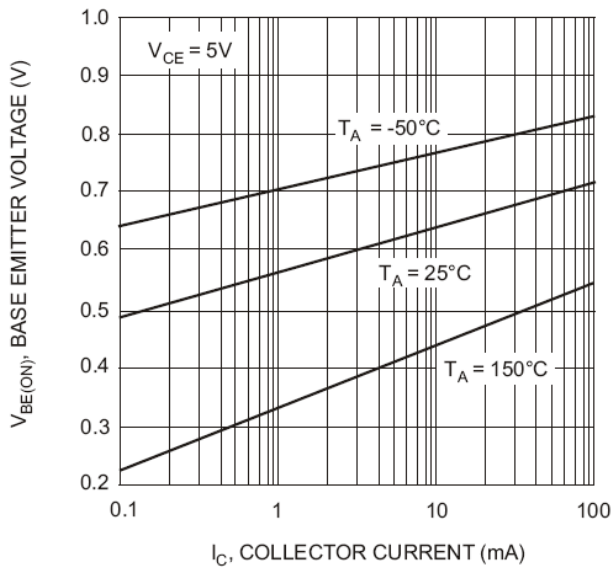

Fig. 6, Base Emitter Voltage vs. Collector Current

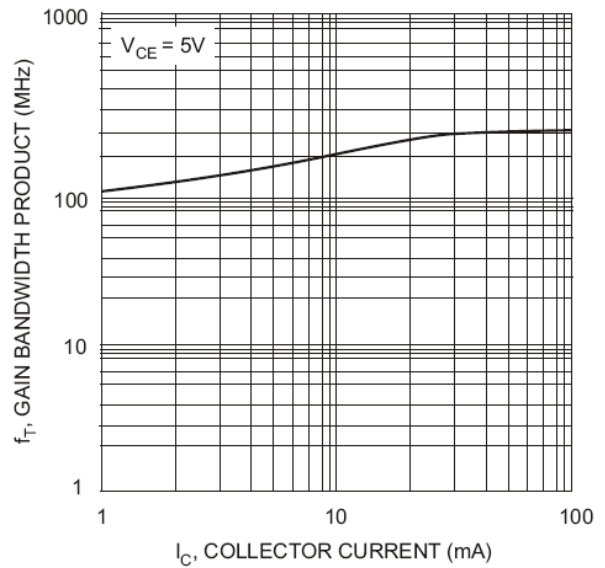

Fig. 7, Gain Bandwidth Product vs. Collector Current

PACKAGE OUTLINE & DIMENSIONS

MMBT2907ADW

SC-88/SOT-363

NOTES:

1. DIMENSIONING AND TOLERANCING PER ANSI Y14.5M, 1982.
2. CONTROLLING DIMENSION: INCH.

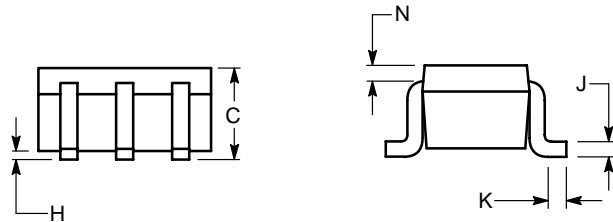
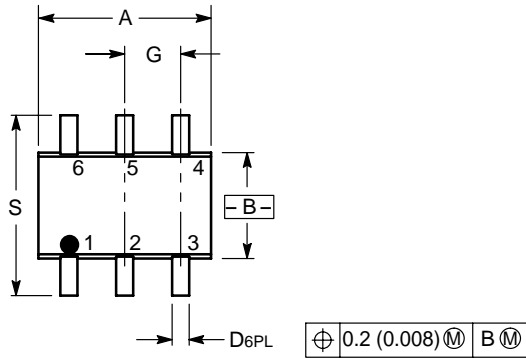

DIM	INCHES		MILLIMETERS	
	MIN	MAX	MIN	MAX
A	0.071	0.087	1.80	2.20
B	0.045	0.053	1.15	1.35
C	0.031	0.043	0.80	1.10
D	0.004	0.012	0.10	0.30
G	0.026 BSC		0.65 BSC	
H	---	0.004	---	0.10
J	0.004	0.010	0.10	0.25
K	0.004	0.012	0.10	0.30
N	0.008 REF		0.20 REF	
S	0.079	0.087	2.00	2.20

- PIN 1. EMITTER 1
 2. BASE 1
 3. COLLECTOR 2
 4. EMITTER 2
 5. BASE 2
 6. COLLECTOR 1

