

Thick Film Chip Resistors / Low Resistance Type

ERJ R, B : 0402, 0603, 0805, 1206, 1210, 1812, 2512

ERJ L : 0603, 0805, 1206, 1210, 1812, 2010, 2512

Type: ERJ 2B, 3R, 3B, 6R, 6B, 8R, 8B,
14R, 14B, 12R, 1TR
ERJ L03, L06, L08, L14, L12,
L1D, L1W

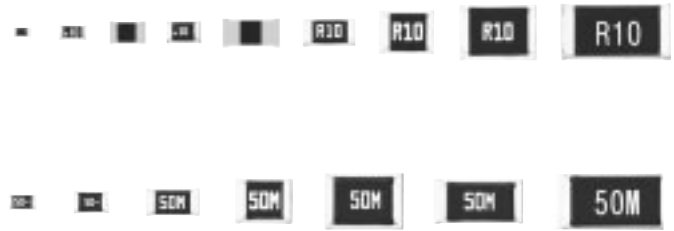

■ Features

- Small size and lightweight
- High reliability
Metal glaze thick film resistive element and three layers of electrodes
- Suitable for both reflow and flow soldering
- Low Resistance Value
ERJ2BW Type : 47 mΩ to 91 mΩ
ERJ6BW, 8BW Type : 10 mΩ to 100 mΩ
ERJ2BS, 2BQ Type : 0.1 Ω to 1.0 Ω
ERJ3R, 3B, 6R, 6B, 8R, 8B, 14R, 14B, 12R, 1TR Type : 0.1 Ω to 9.1 Ω
ERJL03, L06, L08 Type : 47 mΩ to 100 mΩ
ERJL14, L12 Type : 20 mΩ to 100 mΩ
ERJL1D, L1W Type : 40 mΩ to 100 mΩ
- Reference Standards
IEC 60115-8, JIS C 5201-8

■ Explanation of Part Numbers

- ERJ2BS/2BQ, 3R, 3B, 6R, 6B, 8R, 8B, 14R, 14B, 12R, 1TR Series

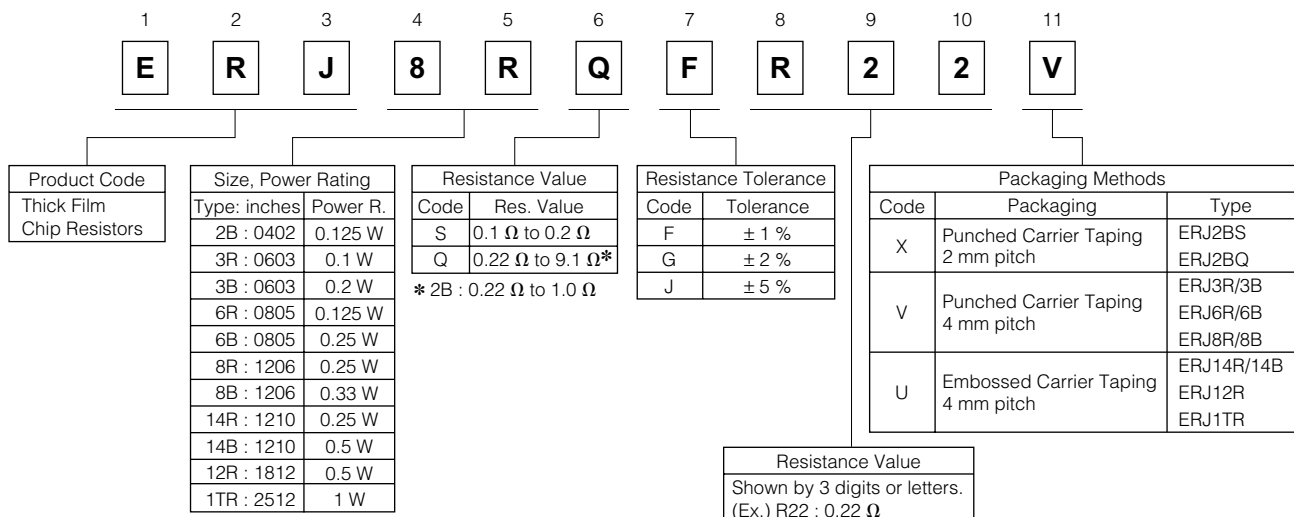

● ERJ2BW, 6BW, 8BW Series

1	2	3	4	5	6	7	8	9	10	11	12
E	R	J	2	B	W	G	R	0	4	7	X

Product Code	Code	Size:inches	Power Rating	Resistance Value	Resistance Tolerance	Packaging Methods			
Thick Film Chip Resistors	2BW	0402	0.125 W	47 mΩ to 91 mΩ	Code	Tolerance	Code	Packaging	Type
	6BW	0805	0.33 W	10 mΩ to 100 mΩ	F	± 1 %	X	Pressed Carrier Taping 2 mm pitch	ERJ2BW
	8BW	1206	0.5 W	10 mΩ to 100 mΩ	G	± 2 %	V	Punched Carrier Taping 4 mm pitch	ERJ6BW ERJ8BW
					J	± 5 %			

Resistance Value	
Shown by 4 digits or letters.	
(Ex.) R047 : 0.047 Ω=47 mΩ	

● ERJL03, L06, L08, L14, L12, L1D, L1W Series

1	2	3	4	5	6	7	8	9	10	11	12
E	R	J	L	1	4	K	J	5	0	M	U

Product Code	Size, Power Rating		Code	Res. Value	Resistance Tolerance	Packaging Methods			
Thick Film Chip Resistors	Type: inches	Power R.	K	Std.	Code	Tolerance	Code	Packaging	Type
	L03 : 0603	0.1 W		(20 mΩ, 22 mΩ, 33 mΩ, *	F	± 1 %	V	Punched Carrier Taping 4 mm pitch	ERJL03 ERJL06 ERJL08
	L06 : 0805	0.125 W	39 mΩ, 47 mΩ, 50 mΩ, *	J	± 5 %	U	Embossed Carrier Taping 4 mm pitch	ERJL14 ERJL12 ERJL1D ERJL1W	
	L08 : 1206	0.25 W	U	20 mΩ to 100 mΩ*					
	L14 : 1210	0.33 W	* L03, L06, L08 : 47 mΩ to 100 mΩ						
	L12 : 1812	0.5 W	L1D, L1W : 40 mΩ to 100 mΩ						
	L1D : 2010	0.5 W							
	L1W : 2512	1 W							

Resistance Value	
Shown by 3 digits or letters.	
(Ex.) 50 M:50 mΩ, 10 C:100 mΩ	

■ Construction

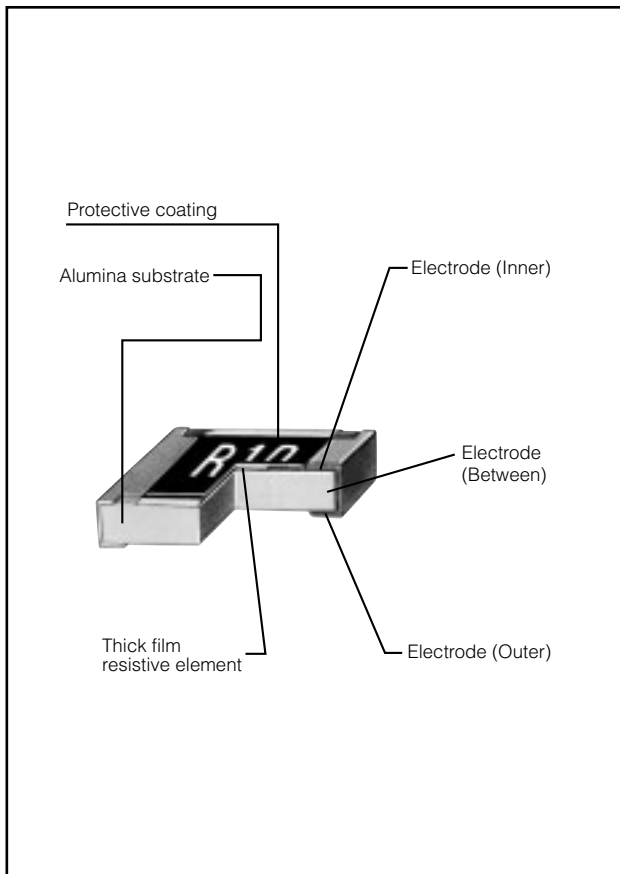

■ Dimensions in mm (not to scale)

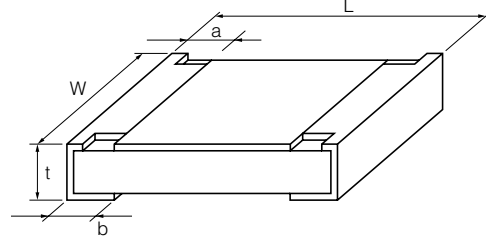

Type (inches)	Dimensions (mm)					Mass(Weight) [g/1000pcs.]
	L	W	a	b	t	
ERJ2BW (0402)	1.00 ^{+0.10}	0.50 ^{+0.10/-0.05}	0.24 ^{+0.10}	0.24 ^{+0.10}	0.35 ^{+0.05}	0.8
ERJ2BS ERJ2BQ (0402)	1.00 ^{+0.10}	0.50 ^{+0.10/-0.05}	0.20 ^{+0.10}	0.27 ^{+0.10}	0.35 ^{+0.05}	0.8
ERJ3R ERJ3B (0603) ERJL03	1.60 ^{+0.15}	0.80 ^{+0.15/-0.05}	0.30 ^{+0.20}	0.30 ^{+0.15}	0.45 ^{+0.10}	2
ERJ6BW(0805) ERJ6R ERJ6B (0805) ERJL06	2.00 ^{+0.20}	1.25 ^{+0.20}	0.55 ^{+0.20}	0.55 ^{+0.20}	0.65 ^{+0.10}	6
ERJ8BW(1206) ERJ8R ERJ8B (1206) ERJL08	3.20 ^{+0.20}	1.60 ^{+0.20}	1.00 ^{+0.20}	1.00 ^{+0.20}	0.65 ^{+0.10}	13
ERJ14R ERJ14B (1210) ERJL14	3.20 ^{+0.20}	2.50 ^{+0.20}	0.50 ^{+0.20}	0.50 ^{+0.20}	0.60 ^{+0.10}	16
ERJ12R ERJL12 (1812)	4.50 ^{+0.20}	3.20 ^{+0.20}	0.50 ^{+0.20}	0.50 ^{+0.20}	0.60 ^{+0.10}	27
ERJL1D (2010)	5.00 ^{+0.20}	2.50 ^{+0.20}	0.60 ^{+0.20}	0.60 ^{+0.20}	0.60 ^{+0.10}	27
ERJ1TR ERJL1W (2512)	6.40 ^{+0.20}	3.20 ^{+0.20}	0.65 ^{+0.20}	0.60 ^{+0.20}	0.60 ^{+0.10}	45
	6.40 ^{+0.20}	3.20 ^{+0.20}	0.65 ^{+0.20}	1.30 ^{+0.20}	1.10 ^{+0.10}	79

■ Ratings

<Low resistance type>

Type (inches)	Power Rating at 70 °C (W)	Resistance Tolerance (%)	Resistance Range (Ω)	T.C.R. [$\times 10^{-6}/^{\circ}\text{C}$ (ppm/ $^{\circ}\text{C}$)]	Category Temperature Range (Operating Temperature Range) ($^{\circ}\text{C}$)
ERJL03 (0603)	0.1 (0.2) *1	$\pm 1, \pm 5$	47 m to 100 m *2	± 200	-55 to +125
ERJL06 (0805)	0.125 (0.25) *1	$\pm 1, \pm 5$	47 m to 100 m *2	± 100	-55 to +125
ERJL08 (1206)	0.25 (0.33) *1	$\pm 1, \pm 5$	47 m to 100 m *2	± 100	-55 to +125
ERJL14 (1210)	0.33	$\pm 1, \pm 5$	20 m to 100 m *2	R < 47 mΩ: ± 300 R \geq 47 mΩ: ± 100	-55 to +125
ERJL12 (1812)	0.5	$\pm 1, \pm 5$	20 m to 100 m *2		-55 to +125
ERJL1D (2010)	0.5	$\pm 1, \pm 5$	40 m to 100 m *2		-55 to +125
ERJL1W (2512)	1	$\pm 1, \pm 5$	40 m to 100 m *2		-55 to +125

*1 Please contact us when resistors with guaranteed high power are needed.

*2 Standard R.V. : 20 mΩ, 22 mΩ, 33 mΩ, 39 mΩ, 47 mΩ, 50 mΩ, 100 mΩ, Custom R.V. : Each 1 mΩ within upper range.

<High power type>

Type (inches)	Power Rating at 70 °C (W)	Resistance Tolerance (%)	Resistance Range (Ω)	T.C.R. [$\times 10^{-6}/^{\circ}\text{C}$ (ppm/ $^{\circ}\text{C}$)]	Category Temperature Range (Operating Temperature Range) ($^{\circ}\text{C}$)
ERJ2BW (0402)	0.125	$\pm 2, \pm 5$	0.047 to 0.091 (E24)	± 300	-55 to +125
ERJ2BS (0402)		$\pm 1, \pm 2, \pm 5$	0.10 to 0.20 (E24)		
ERJ2BQ (0402)			0.22 to 1.0 (E24)		
ERJ3BS (0603)	0.2	$\pm 1, \pm 2, \pm 5$	0.10 to 0.20 (E24)	± 300	-55 to +125
ERJ3BQ (0603)			0.22 to 0.91 (E24)		
			1.0 to 9.1 (E24)		
ERJ6BW (0805)	0.33	$\pm 1, \pm 2, \pm 5$	0.01 to 0.1 (E24)	R < 0.015 Ω: ± 300 R \geq 0.015 Ω: ± 200	-55 to +155
ERJ6BS (0805)	0.25		0.10 to 0.20 (E24)	± 250	-55 to +125
ERJ6BQ (0805)			0.22 to 0.91 (E24)		
			1.0 to 9.1 (E24)	± 200	
ERJ8BW (1206)	0.5	$\pm 1, \pm 2, \pm 5$	0.01 to 0.1 (E24)	0.010 Ω \leq R < 0.020 Ω: ± 200 0.020 Ω \leq R < 0.047 Ω: ± 150 0.047 Ω \leq R \leq 0.100 Ω: ± 100	-55 to +155
ERJ8BS (1206)	0.33	$\pm 1, \pm 2, \pm 5$	0.10 to 0.20 (E24)	± 250	-55 to +125
ERJ8BQ (1206)			0.22 to 0.91 (E24)		
			1.0 to 9.1 (E24)		
ERJ14BS (1210)	0.5	$\pm 1, \pm 2, \pm 5$	0.10 to 0.20 (E24)	± 200	-55 to +125
ERJ14BQ (1210)			0.22 to 0.91 (E24)		
			1.0 to 9.1 (E24)		

<Standard type>

Type (inches)	Power Rating at 70 °C (W)	Resistance Tolerance (%)	Resistance Range (Ω)	T.C.R. [$\times 10^{-6}/^{\circ}\text{C}$ (ppm/ $^{\circ}\text{C}$)]	Category Temperature Range (Operating Temperature Range) ($^{\circ}\text{C}$)
ERJ3RS (0603)	0.1	$\pm 1, \pm 2, \pm 5$	0.10 to 0.20 (E24)	± 300	-55 to +125
ERJ3RQ (0603)			0.22 to 0.91 (E24)		
			1.0 to 9.1 (E24)		
ERJ6RS (0805)	0.125	$\pm 1, \pm 2, \pm 5$	0.10 to 0.20 (E24)	± 250	-55 to +125
ERJ6RQ (0805)			0.22 to 0.91 (E24)		
			1.0 to 9.1 (E24)		
ERJ8RS (1206)	0.25	$\pm 1, \pm 2, \pm 5$	0.10 to 0.20 (E24)	± 250	-55 to +125
ERJ8RQ (1206)			0.22 to 0.91 (E24)		
			1.0 to 9.1 (E24)		
ERJ14RS (1210)	0.25	$\pm 1, \pm 2, \pm 5$	0.10 to 0.20 (E24)	± 200	-55 to +125
ERJ14RQ (1210)			0.22 to 0.91 (E24)		
			1.0 to 9.1 (E24)		
ERJ12RS (1812)	0.5	$\pm 1, \pm 2, \pm 5$	0.10 to 0.20 (E24)	± 200	-55 to +125
ERJ12RQ (1812)			0.22 to 0.91 (E24)		
			1.0 to 9.1 (E24)		
ERJ1TRS (2512)	1	$\pm 1, \pm 2, \pm 5$	0.10 to 0.20 (E24)	± 200	-55 to +125
ERJ1TRQ (2512)			0.22 to 0.91 (E24)		
			1.0 to 9.1 (E24)		

Power Derating Curve

For resistors operated in ambient temperatures above 70 °C, power rating shall be derated in accordance with the figure on the right.

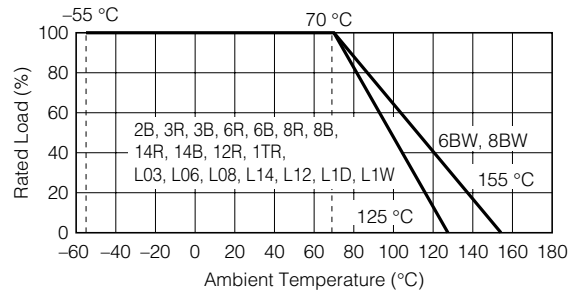

■ Packaging Methods (Taping)

● Standard Quantity

Type	Kind of Taping	Pitch (P ₁)	Quantity
ERJ2BW	Pressed Carrier Taping	2 mm	10000 pcs./reel
ERJ2BS, 2BQ	Punched Carrier Taping		
ERJ3R, 3B, L03			
ERJ6R, 6B, L06			
ERJ8R, 8B, L08			
ERJ14R, 14B, L14			
ERJ12R, L12	Embossed Carrier Taping	4 mm	5000 pcs./reel
ERJL1D			
ERJ1TR			
ERJL1W			
			4000 pcs./reel
			3000 pcs./reel

● Carrier Tape

(Unit : mm)

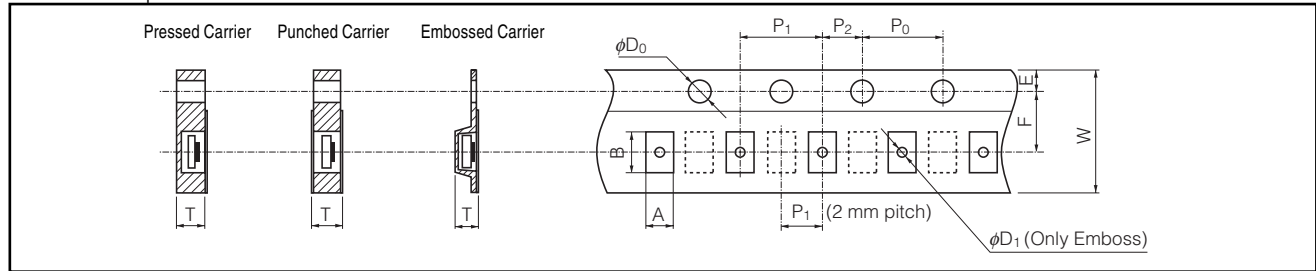

Type	A	B	W	F	E	P ₁	P ₂	P ₀	φD ₀	T	φD ₁
ERJ2BW	0.67 ^{±0.10}	1.17 ^{±0.10}	8.00 ^{±0.20}	3.50 ^{±0.05}	1.75 ^{±0.10}	2.00 ^{±0.10}				0.61 ^{±0.05}	–
ERJ2BS, 2BQ	0.67 ^{±0.05}	1.17 ^{±0.05}								0.52 ^{±0.05}	–
ERJ3R, 3B, L03	1.10 ^{±0.10}	1.90 ^{±0.05}				0.70 ^{±0.05}	–				
ERJ6BW	1.55 ^{±0.15}	2.30 ^{±0.20}				–	–				
ERJ6R, 6B, L06	1.65 ^{±0.15}	2.50 ^{±0.20}				0.84 ^{±0.05}	–				
ERJ8BW, 8R, 8B, L08	2.00 ^{±0.15}	3.60 ^{±0.20}	–	–							
ERJ14R, 14B, L14	2.80 ^{±0.20}	3.50 ^{±0.20}	8.00 ^{±0.30}	5.50 ^{±0.20}		4.00 ^{±0.10}	2.00 ^{±0.05}	4.00 ^{±0.10}	1.50 ^{±0.10}	1.0 ^{±0.10}	1.5 min.
ERJ12R, L12	3.50 ^{±0.20}	4.80 ^{±0.20}	1.00 ^{±0.10}							–	
ERJL1D	2.80 ^{±0.20}	5.30 ^{±0.20}	12.00 ^{±0.30}	5.50 ^{±0.20}						1.60 ^{±0.10}	–
ERJ1TR	3.60 ^{±0.20}	6.90 ^{±0.20}								–	–
ERJL1W	3.60 ^{±0.20}	6.90 ^{±0.20}								–	–

● Taping Reel

(Unit : mm)

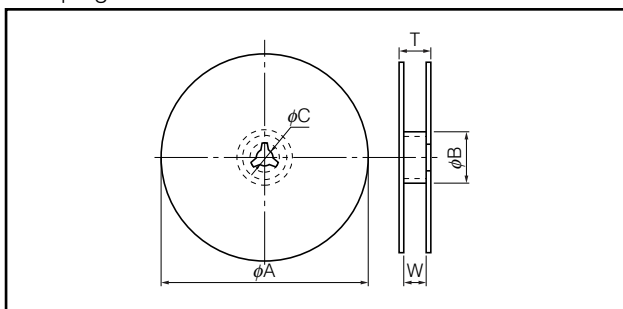

Type	φA	φB	φC	W	T
ERJ2B	180.0 ⁺⁰ _{-3.0}	60 min.	13.0 ^{±1.0}	9.0 ^{±1.0}	11.4 ^{±1.0}
ERJ3R, 3B, L03					
ERJ6R, 6B, L06					
ERJ8R, 8B, L08					
ERJ14R, 14B, L14					
ERJ12R, L12	13.0 ^{±1.0}	15.4 ^{±2.0}			
ERJL1D					
ERJ1TR					
ERJL1W					

Recommended Land Pattern

In case of flow soldering, the land width must be smaller than the Chip Resistor width to control the solder amount properly. Generally, the land width should be 0.7 to 0.8 times (W) of the width of chip resistor. In case of reflow soldering, solder amount can be adjusted, therefore the land width should be set to 1.0 to 1.3 times chip resistor width (W).

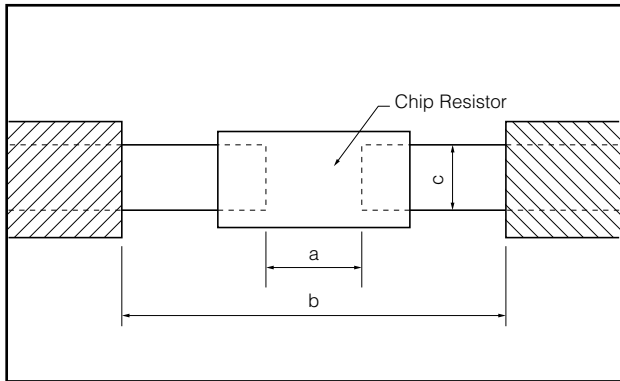

Type (inches)	Dimensions (mm)		
	a	b	c
ERJ2BW (0402)	0.52	1.4 to 1.6	0.4 to 0.6
ERJ2B (0402)	0.5 to 0.6	1.4 to 1.6	0.4 to 0.6
ERJ3R, 3B, L03 (0603)	0.7 to 0.9	2 to 2.2	0.8 to 1
ERJ6BW (0805)	0.9	3.2 to 3.8	1.1 to 1.4
ERJ6R, 6B, L06 (0805)	1 to 1.4	3.2 to 3.8	0.9 to 1.4
ERJ8BW (1206)	1.2	4.4 to 5	1.3 to 1.8
ERJ8R, 8B, L08 (1206)	2 to 2.4	4.4 to 5	1.2 to 1.8
ERJ14R, 14B, L14 (1210)	2 to 2.4	4.4 to 5	1.8 to 2.8
ERJ12R, L12 (1812)	3.3 to 3.7	5.7 to 6.5	2.3 to 3.5
ERJL1D (2010)	3.6 to 4	6.2 to 7	1.8 to 2.8
ERJ1TR (2512)	5 to 5.4	7.6 to 8.6	2.3 to 3.5
ERJL1W (2512)	3.6 to 4	7.6 to 8.6	2.3 to 3.5

Recommended Soldering Conditions

Recommendations and precautions are described below.

Recommended soldering conditions for reflow

- Reflow soldering shall be performed a maximum of two times.
- Please contact us for additional information when used in conditions other than those specified.
- Please measure the temperature of the terminals and study every kind of solder and printed circuit board for solderability before actual use.

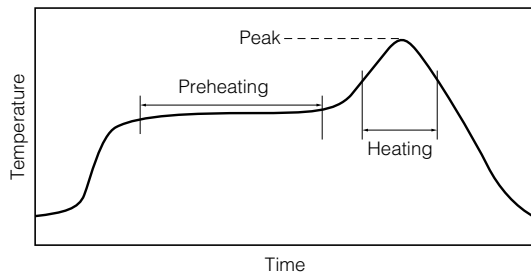

For soldering (Example : Sn/Pb)

	Temperature	Time
Preheating	140 °C to 160 °C	60 s to 120 s
Main heating	Above 200 °C	30 s to 40 s
Peak	235 ± 5 °C	max. 10 s

For lead-free soldering (Example : Sn/Ag/Cu)

	Temperature	Time
Preheating	150 °C to 180 °C	60 s to 120 s
Main heating	Above 230 °C	30 s to 40 s
Peak	max. 260 °C	max. 10 s

Recommended soldering conditions for flow

	For soldering		For lead-free soldering	
	Temperature	Time	Temperature	Time
Preheating	140 °C to 180 °C	60 s to 120 s	150 °C to 180 °C	60 s to 120 s
Soldering	245 ± 5 °C	20 s to 30 s	max. 260 °C	max. 10 s

⚠ Safety Precautions

The following are precautions for individual products. Please also refer to the precautions common to Fixed Resistors shown on page ER2 of this catalog.

- Take measures against mechanical stress during and after mounting of Thick Film Chip Resistors (hereafter called the resistors) so as not to damage their electrodes and protective coatings.
- If a transient load (heavy load in a short time) like a pulse is expected to be applied, check and evaluate the operations of the resistors when installed in your products before use.
Never exceed the rated power. Otherwise, the performance and/or reliability of the resistors may be impaired.
- Do not use halogen-based or other high-activity flux. Otherwise, the residue may impair the resistors' performance and/or reliability.
- When soldering with a soldering iron, never touch the resistors' bodies with the tip of the soldering iron. When using a soldering iron with a high temperature tip, finish soldering as quickly as possible (within three seconds at 350 °C max.).
- As the amount of applied solder becomes larger, the mechanical stress applied to the resistors increases, causing problems such as cracks and faulty characteristics. Avoid applying an excessive amount of solder.
- Do not apply shock to the resistors or pinch them with a hard tool (e.g. pliers and tweezers). Otherwise, the resistors' protective coatings and bodies may be chipped, affecting their performance.
- Avoid excessive bending of printed circuit boards in order to protect the resistors from abnormal stress.

Safety Precautions (Common precautions for Fixed Resistors)

- When using our products, no matter what sort of equipment they might be used for, be sure to make a written agreement on the specifications with us in advance. The design and specifications in this catalog are subject to change without prior notice.
- Do not use the products beyond the specifications described in this catalog.
- This catalog explains the quality and performance of the products as individual components. Before use, check and evaluate their operations when installed in your products.
- Install the following systems for a failsafe design to ensure safety if these products are to be used in equipment where a defect in these products may cause the loss of human life or other significant damage, such as damage to vehicles (automobile, train, vessel), traffic lights, medical equipment, aerospace equipment, electric heating appliances, combustion/gas equipment, rotating equipment, and disaster/crime prevention equipment.
- * Systems equipped with a protection circuit and a protection device
- * Systems equipped with a redundant circuit or other system to prevent an unsafe status in the event of a single fault

(1) Precautions for use

- These products are designed and manufactured for general and standard use in general electronic equipment (e.g. AV equipment, home electric appliances, office equipment, information and communication equipment)
- These products are not intended for use in the following special conditions. Before using the products, carefully check the effects on their quality and performance, and determine whether or not they can be used.
 1. In liquid, such as water, oil, chemicals, or organic solvent
 2. In direct sunlight, outdoors, or in dust
 3. In salty air or air with a high concentration of corrosive gas, such as Cl₂, H₂S, NH₃, SO₂, or NO₂
 4. Electric Static Discharge (ESD) Environment
 - These components are sensitive to static electricity and can be damaged under static shock (ESD). Please take measures to avoid any of these environments.
 - Smaller components are more sensitive to ESD environment.
 5. Electromagnetic Environment
 - Avoid any environment where strong electromagnetic waves exist.
 6. In an environment where these products cause dew condensation
 7. Sealing or coating of these products or a printed circuit board on which these products are mounted, with resin or other materials
- These products generate Joule heat when energized. Carefully position these products so that their heat will not affect the other components.
- Carefully position these products so that their temperatures will not exceed the category temperature range due to the effects of neighboring heat-generating components. Do not mount or place heat-generating components or inflammables, such as vinyl-coated wires, near these products .
- Note that non-cleaning solder, halogen-based highly active flux, or water-soluble flux may deteriorate the performance or reliability of the products.
- Carefully select a flux cleaning agent for use after soldering. An unsuitable agent may deteriorate the performance or reliability. In particular, when using water or a water-soluble cleaning agent, be careful not to leave water residues. Otherwise, the insulation performance may be deteriorated.

(2) Precautions for storage

The performance of these products, including the solderability, is guaranteed for a year from the date of arrival at your company, provided that they remain packed as they were when delivered and stored at a temperature of 5 °C to 35 °C and a relative humidity of 45 % to 85 %.

Even within the above guarantee periods, do not store these products in the following conditions. Otherwise, their electrical performance and/or solderability may be deteriorated, and the packaging materials (e.g. taping materials) may be deformed or deteriorated, resulting in mounting failures.

1. In salty air or in air with a high concentration of corrosive gas, such as Cl₂, H₂S, NH₃, SO₂, or NO₂
2. In direct sunlight

<Package markings>

Package markings include the product number, quantity, and country of origin. In principle, the country of origin should be indicated in English.