

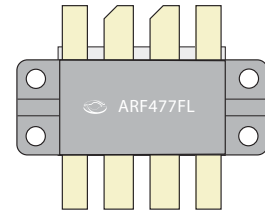

Common Source  
Push-Pull Pair

**ARF477FL**

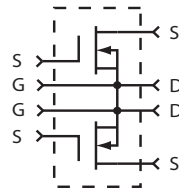

# RF POWER MOSFET

## N-CHANNEL PUSH - PULL PAIR

**165V 400W 100MHz**

The ARF477FL is a matched pair of RF power transistors in a common source configuration. It is designed for high voltage push-pull or parallel operation in ISM and MRI power amplifiers up to 100 MHz.

- **Specified 150 Volt, 65 MHz Characteristics:**
  - Output Power = 400 Watts
  - Gain = 15dB (Class AB)
  - Efficiency = 50% min
- **High Performance Push-Pull RF Package.**
- **High Voltage Breakdown and Large SOA for Superior Ruggedness.**
- **Low Thermal Resistance.**
- **RoHS Compliant**

### MAXIMUM RATINGS

All Ratings:  $T_C = 25^\circ\text{C}$  unless otherwise specified.

Symbol	Parameter	Ratings	Unit
$V_{DSS}$	Drain-Source Voltage	500	V
$V_{DGO}$	Drain-Gate Voltage	500	
$I_D$	Continuous Drain Current @ $T_C = 25^\circ\text{C}$ (each device)	15	A
$V_{GS}$	Gate-Source Voltage	$\pm 30$	V
$P_D$	Total Power Dissipation @ $T_C = 25^\circ\text{C}$	750	W
$T_J, T_{STG}$	Operating and Storage Junction Temperature Range	-55 to 175	$^\circ\text{C}$
$T_L$	Lead Temperature: 0.063" from Case for 10 Sec.	300	

### Static Electrical Characteristics

Symbol	Parameter	Min	Typ	Max	Unit
$BV_{DSS}$	Drain-Source Breakdown Voltage ( $V_{GS} = 0V, I_D = 250 \mu\text{A}$ )	500			V
$V_{DS(ON)}$	On State Drain Voltage <sup>1</sup> ( $I_{D(ON)} = 7.5A, V_{GS} = 10V$ )		2.9	4	
$I_{DSS}$	Zero Gate Voltage Drain Current ( $V_{DS} = V_{DSS}, V_{GS} = 0V$ )			25	$\mu\text{A}$
	Zero Gate Voltage Drain Current ( $V_{DS} = 50V_{DSS}, V_{GS} = 0, T_C = 125^\circ\text{C}$ )			250	
$I_{GSS}$	Gate-Source Leakage Current ( $V_{GS} = \pm 30V, V_{DS} = 0V$ )			$\pm 100$	nA
$g_{fs}$	Forward Transconductance ( $V_{DS} = 15V, I_D = 7.5A$ )	3.5	5.6	8	mhos
$g_{fs1}/g_{fs2}$	Forward Transconductance Match Ratio ( $V_{DS} = 15V, I_D = 5A$ )	0.9		1.1	
$V_{GS(TH)}$	Gate Threshold Voltage ( $V_{DS} = V_{GS}, I_D = 50mA$ )	3		5	
$V_{GS(TH)}$	Gate Threshold Voltage Match ( $V_{DS} = V_{GS}, I_D = 50mA$ )			0.2	Volts

### Thermal Characteristics

Symbol	Parameter	Min	Typ	Max	Unit
$R_{\theta JC}$	Junction to Case		0.18	0.2	$^\circ\text{C/W}$
$R_{\theta JHS}$	Junction to Sink (High Efficiency Thermal Joint Compound and Planar Heat Sink Surface.)		0.30	0.32	



**CAUTION:** These Devices are Sensitive to Electrostatic Discharge. Proper Handling Procedures Should Be Followed.

Microsemi Website - <http://www.microsemi.com>

Symbol	Parameter	Test Conditions	Min	Typ	Max	Unit
$C_{iss}$	Input Capacitance	$V_{GS} = 0V$ $V_{DS} = 150V$ $f = 1MHz$		1200	1400	pF
$C_{oss}$	Output Capacitance			150	180	
$C_{rss}$	Reverse Transfer Capacitance			60	75	
$t_{d(on)}$	Turn-on Delay Time	$V_{GS} = 15V$ $V_{DD} = 250V$ $I_D = I_{D[Cont.]} @ 25^\circ C$ $R_G = 1.6 \Omega$		7		nS
$t_r$	Rise Time			6		
$t_{d(off)}$	Turn-off Delay Time			20		
$t_f$	Fall Time			4.0	7	

Functional Characteristics

Symbol	Characteristic	Test Conditions	Min	Typ	Max	Unit
$G_{PS}$	Common Source Amplifier Power Gain	$f = 65MHz$ $I_{dq} = 0mA$ $V_{DD} = 150V$ $P_{OUT} = 400W$	14	16		dB
$\eta$	Drain Efficiency		50	55		%
$\Psi$	Electrical Ruggedness VSWR 10:1		No Degradation in Output Power			

1. Pulse Test: Pulse width < 380  $\mu S$ , Duty Cycle < 2%.

Microsemi reserves the right to change, without notice, the specifications and information contained herein.

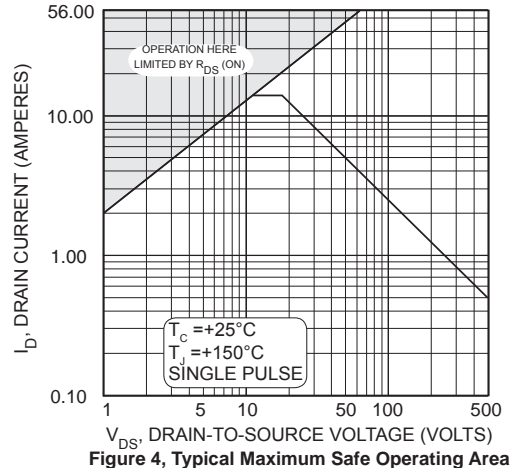
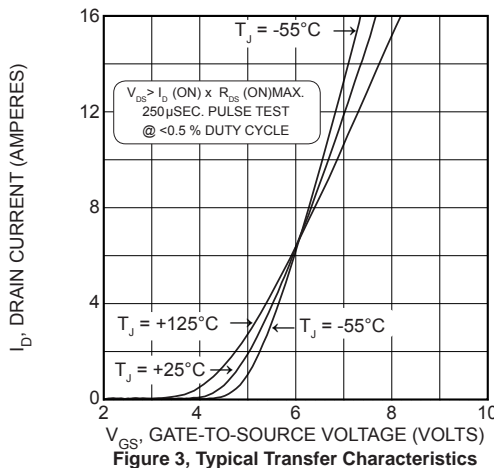
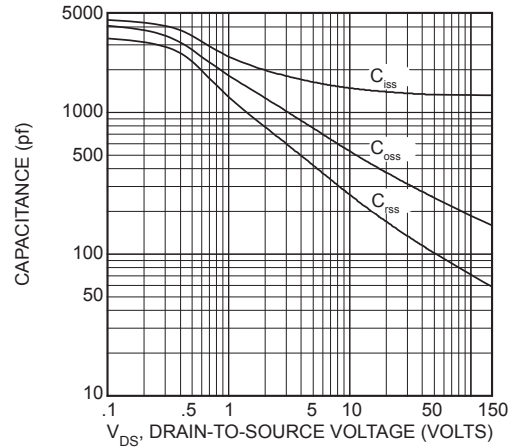
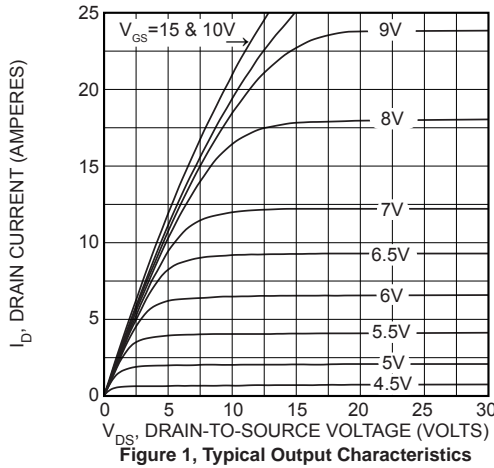

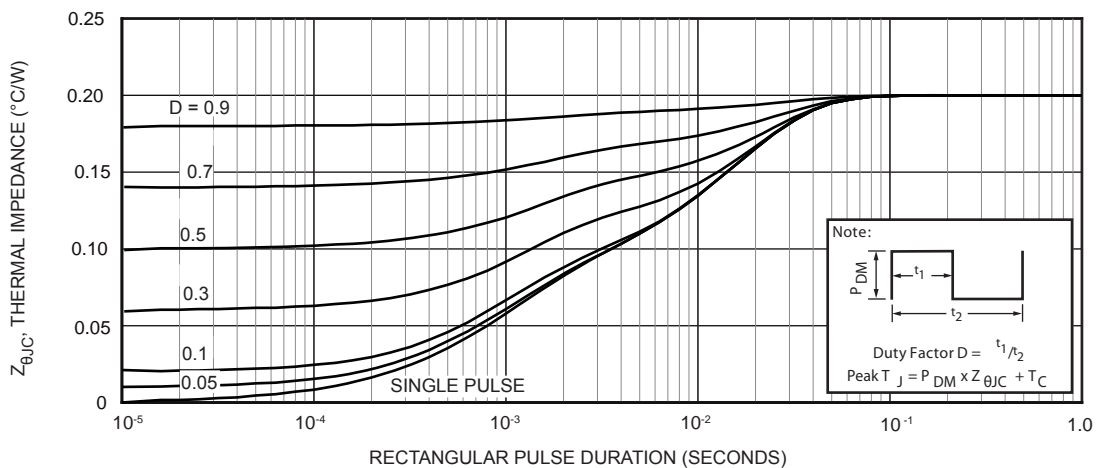

Figure 5a, Maximum Effective Transient Thermal Impedance, Junction-To-Case vs Pulse Duration

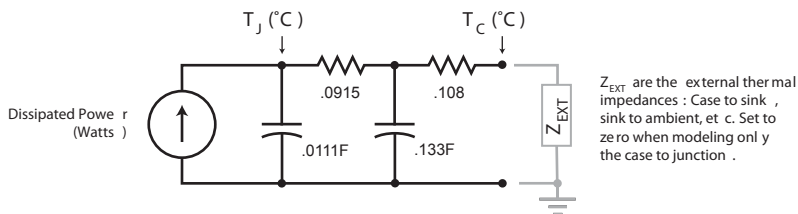
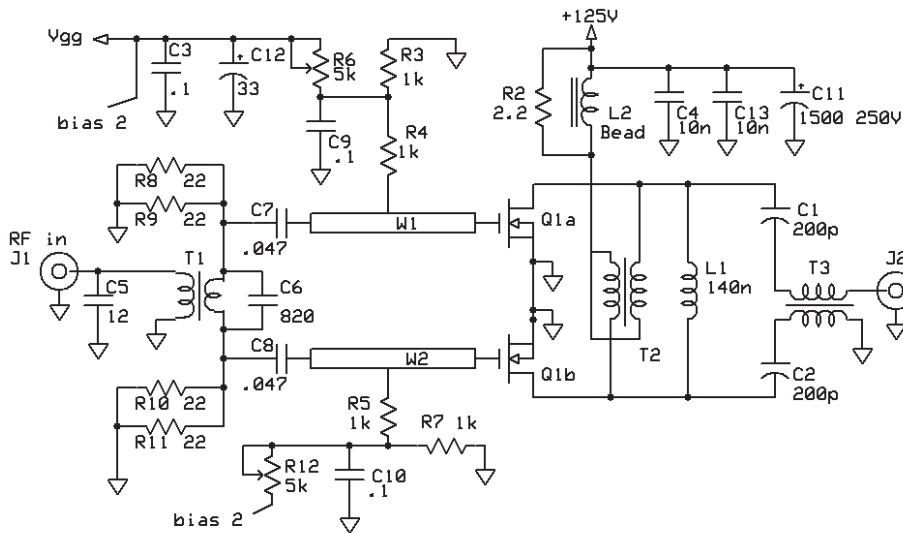

Figure 5b, TRANSIENT THERMAL IMPEDANCE MODEL

Freq. (MHz)	Z <sub>in</sub> (Ω)	Z <sub>OUT</sub> (Ω)
40	1.5 - j 10	24 - j 37
60	1.9 - j 1.3	13 - j 29
80	2.2 - j 0.82	7.9 - j 24

Z<sub>IN</sub> - Gate shunted with 100Ω I<sub>dq</sub> = 0  
 Z<sub>OL</sub> - Conjugate of optimum load for 400 Watts output at V<sub>ds</sub>=125V

65MHz Test Circuit



C6 - ATC 100B type  
 L1 - 4.5t #18 enam .312"dia  
 L2 = 2t #18 on FairRite 2643800302 bead  
 R8-R11 - 22 ohm 1W SMT  
 T1 = 4:1 2t #20 1t 1.5" braid on 2861001502

T2 = 6t #22 bifilar on FairRite 5961000301  
 T3 = 2t RG316 on FairRite 2861010002  
 Q1a/b ARF477FL  
 W1, W2 - 1.4" x .2"  
 PWB = FR-4 fiberglass er= 4.6

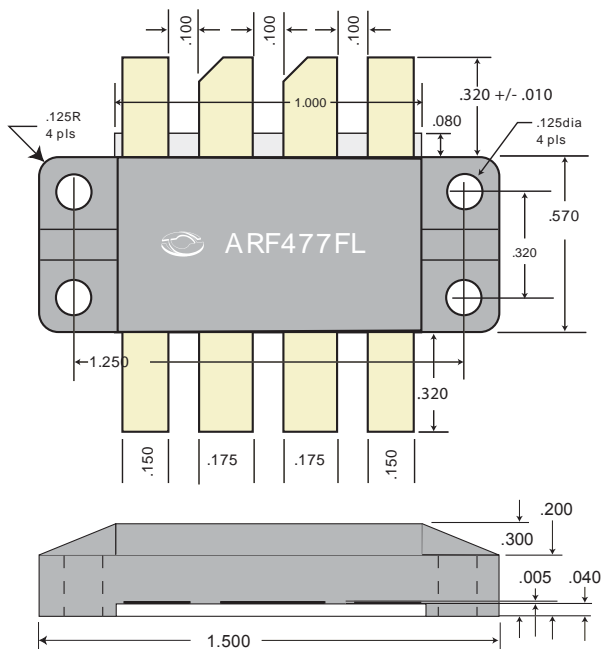

Thermal Considerations and Package Mounting:

The rated power dissipation is only available when the package mounting surface is at 25°C and the junction temperature is 175°C. The thermal resistance between junctions and case mounting surface is 0.23 °C/W. When installed, an additional thermal impedance of 0.07°C/W between the package base and the mounting surface is typical. Insure that the mounting surface is smooth and flat. Thermal joint compound must be used to reduce the effects of small surface irregularities. Use the minimum amount necessary to coat the surface. The heatsink should incorporate a copper heat spreader to obtain best results.

The package design clamps the ceramic base to the heatsink. A clamped joint maintains the required mounting pressure while allowing for thermal expansion of both the base and the heat sink. Four 4-40 (M3) screws provide the required mounting force. T = 3-4 in-lb (0.34-0.45 N-m).

HAZARDOUS MATERIAL WARNING

The white ceramic portion of the device between leads and mounting surface is beryllium oxide, BeO. Beryllium oxide dust is toxic when inhaled. Care must be taken during handling and mounting to avoid damage to this area. These devices must never be thrown away with general industrial or domestic waste.

Microsemi's products are covered by one or more of U.S. patents 4,895,810 5,045,903 5,089,434 5,182,234 5,019,522 5,262,336 6,503,786 5,256,583 4,748,103 5,283,202 5,231,474 5,434,095 5,528,058 6,939,743, 7,352,045 5,283,201 5,801,417 5,648,283 7,196,634 6,664,594 7,157,886 6,939,743 7,342,262 and foreign patents. US and Foreign patents pending. All Rights Reserved.

**Disclaimer:**

The information contained in the document (unless it is publicly available on the Web without access restrictions) is PROPRIETARY AND CONFIDENTIAL information of Microsemi and cannot be copied, published, uploaded, posted, transmitted, distributed or disclosed or used without the express duly signed written consent of Microsemi. If the recipient of this document has entered into a disclosure agreement with Microsemi, then the terms of such Agreement will also apply. This document and the information contained herein may not be modified, by any person other than authorized personnel of Microsemi. No license under any patent, copyright, trade secret or other intellectual property right is granted to or conferred upon you by disclosure or delivery of the information, either expressly, by implication, inducement, estoppels or otherwise. Any license under such intellectual property rights must be approved by Microsemi in writing signed by an officer of Microsemi.

Microsemi reserves the right to change the configuration, functionality and performance of its products at anytime without any notice. This product has been subject to limited testing and should not be used in conjunction with life-support or other mission-critical equipment or applications. Microsemi assumes no liability whatsoever, and Microsemi disclaims any express or implied warranty, relating to sale and/or use of Microsemi products including liability or warranties relating to fitness for a particular purpose, merchantability, or infringement of any patent, copyright or other intellectual property right. Any performance specifications believed to be reliable but are not verified and customer or user must conduct and complete all performance and other testing of this product as well as any user or customer's final application. User or customer shall not rely on any data and performance specifications or parameters provided by Microsemi. It is the customer's and user's responsibility to independently determine suitability of any Microsemi product and to test and verify the same. The information contained herein is provided "AS IS, WHERE IS" and with all faults, and the entire risk associated with such information is entirely with the User. Microsemi specifically disclaims any liability of any kind including for consequential, incidental and punitive damages as well as lost profit. The product is subject to other terms and conditions which can be located on the web at <http://www.microsemi.com/terms-a-conditions>.