

- ★ Super Low Gate Charge
- ★ Green Device Available
- ★ Excellent Cdv/dt effect decline
- ★ Advanced high cell density Trench technology

### Product Summary



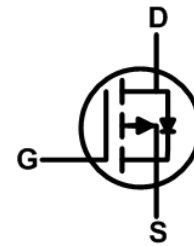
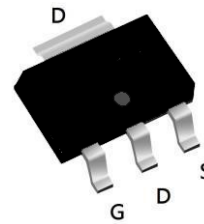
BVDSS	RDSON	ID
-100V	0.65Ω	-1.5A

### Description

The PKL0107 is the high cell density trenched P-ch MOSFETs, which provide excellent RDSON and gate charge for most of the synchronous buck converter applications.

The PKL0107 meet the RoHS and Green Product requirement with full function reliability approved.

### SOT223 Pin Configuration



### Absolute Maximum Ratings

Symbol	Parameter	Rating	Units
$V_{DS}$	Drain-Source Voltage	-100	V
$V_{GS}$	Gate-Source Voltage	$\pm 20$	V
$I_D@T_A=25^\circ C$	Continuous Drain Current, $V_{GS} @ -10V^1$	-1.5	A
$I_D@T_A=70^\circ C$	Continuous Drain Current, $V_{GS} @ -10V^1$	-1.2	A
$I_{DM}$	Pulsed Drain Current <sup>2</sup>	-4.5	A
$P_D@T_A=25^\circ C$	Total Power Dissipation <sup>3</sup>	1.5	W
$T_{STG}$	Storage Temperature Range	-55 to 150	$^\circ C$
$T_J$	Operating Junction Temperature Range	-55 to 150	$^\circ C$

### Thermal Data

Symbol	Parameter	Typ.	Max.	Unit
$R_{\theta JA}$	Thermal Resistance Junction-ambient <sup>1</sup>	---	85	$^\circ C/W$
$R_{\theta JC}$	Thermal Resistance Junction-Case <sup>1</sup>	---	36	$^\circ C/W$

### Electrical Characteristics ( $T_J=25^\circ\text{C}$ , unless otherwise noted)

Symbol	Parameter	Conditions	Min.	Typ.	Max.	Unit
$BV_{DSS}$	Drain-Source Breakdown Voltage	$V_{GS}=0V, I_D=-250\mu A$	-100	---	---	V
$\Delta BV_{DSS}/\Delta T_J$	$BV_{DSS}$ Temperature Coefficient	Reference to $25^\circ\text{C}$ , $I_D=-1\text{mA}$	---	-0.0624	---	$V/^\circ\text{C}$
$R_{DS(ON)}$	Static Drain-Source On-Resistance <sup>2</sup>	$V_{GS}=-10V, I_D=-1A$	---	0.52	0.65	$\Omega$
		$V_{GS}=-4.5V, I_D=-0.5A$	---	0.56	0.7	
$V_{GS(th)}$	Gate Threshold Voltage	$V_{GS}=V_{DS}, I_D=-250\mu A$	-1.0	-1.5	-2.5	V
$\Delta V_{GS(th)}$	$V_{GS(th)}$ Temperature Coefficient		---	4.5	---	$\text{mV}/^\circ\text{C}$
$I_{DSS}$	Drain-Source Leakage Current	$V_{DS}=-80V, V_{GS}=0V, T_J=25^\circ\text{C}$	---	---	10	$\mu A$
		$V_{DS}=-80V, V_{GS}=0V, T_J=55^\circ\text{C}$	---	---	100	
$I_{GSS}$	Gate-Source Leakage Current	$V_{GS}=\pm 20V, V_{DS}=0V$	---	---	$\pm 100$	nA
$g_{fs}$	Forward Transconductance	$V_{DS}=-5V, I_D=-1A$	---	2.9	---	S
$R_g$	Gate Resistance	$V_{DS}=0V, V_{GS}=0V, f=1\text{MHz}$	---	16	32	$\Omega$
$Q_g$	Total Gate Charge (-10V)	$V_{DS}=-50V, V_{GS}=-10V, I_D=-1A$	---	9.3	---	nC
$Q_{gs}$	Gate-Source Charge		---	1.75	---	
$Q_{gd}$	Gate-Drain Charge		---	1.25	---	
$T_{d(on)}$	Turn-On Delay Time	$V_{DD}=-50V, V_{GS}=-10V, R_G=3.3\Omega, I_D=-0.5A$	---	2	---	ns
$T_r$	Rise Time		---	18.4	---	
$T_{d(off)}$	Turn-Off Delay Time		---	19.6	---	
$T_f$	Fall Time		---	19.6	---	
$C_{iss}$	Input Capacitance	$V_{DS}=-15V, V_{GS}=0V, f=1\text{MHz}$	---	553	---	pF
$C_{oss}$	Output Capacitance		---	29	---	
$C_{rss}$	Reverse Transfer Capacitance		---	20	---	

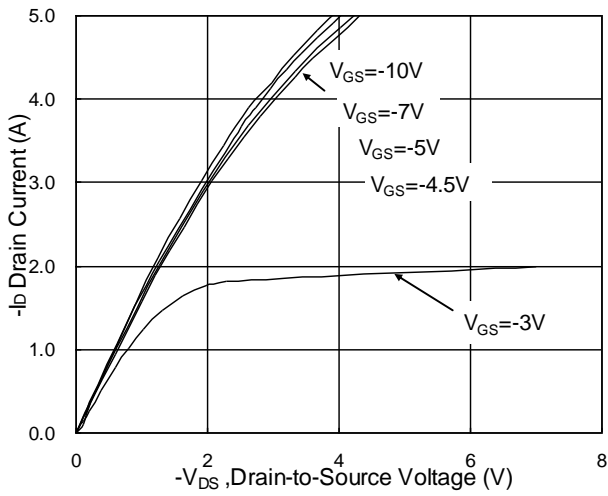
### Diode Characteristics

Symbol	Parameter	Conditions	Min.	Typ.	Max.	Unit
$I_S$	Continuous Source Current <sup>1,4</sup>	$V_G=V_D=0V$ , Force Current	---	---	-1.5	A
$I_{SM}$	Pulsed Source Current <sup>2,4</sup>		---	---	-4.5	A
$V_{SD}$	Diode Forward Voltage <sup>2</sup>	$V_{GS}=0V, I_S=-1A, T_J=25^\circ\text{C}$	---	---	-1.2	V
$t_{rr}$	Reverse Recovery Time	$I_F=-1A, dI/dt=100A/\mu s, T_J=25^\circ\text{C}$	---	27	---	nS
$Q_{rr}$	Reverse Recovery Charge		---	36	---	nC

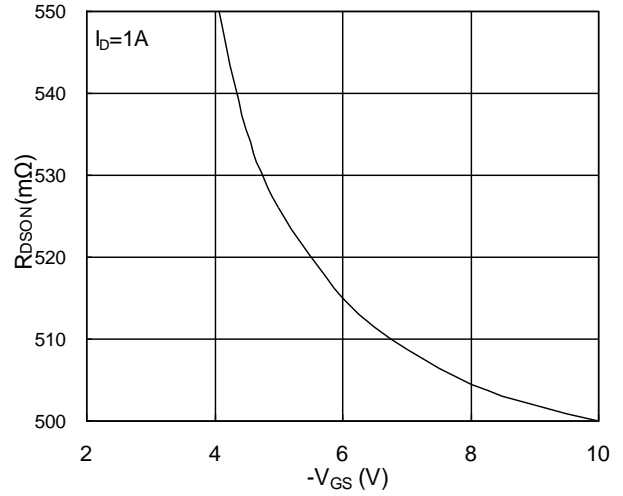
Note :

- 1.The data tested by surface mounted on a 1 inch<sup>2</sup> FR-4 board with 20Z copper.
- 2.The data tested by pulsed , pulse width  $\leq 300\mu s$ , duty cycle  $\leq 2\%$
- 3.The power dissipation is limited by  $150^\circ\text{C}$  junction temperature
- 4.The data is theoretically the same as  $I_D$  and  $I_{DM}$ , in real applications , should be limited by total power dissipation.

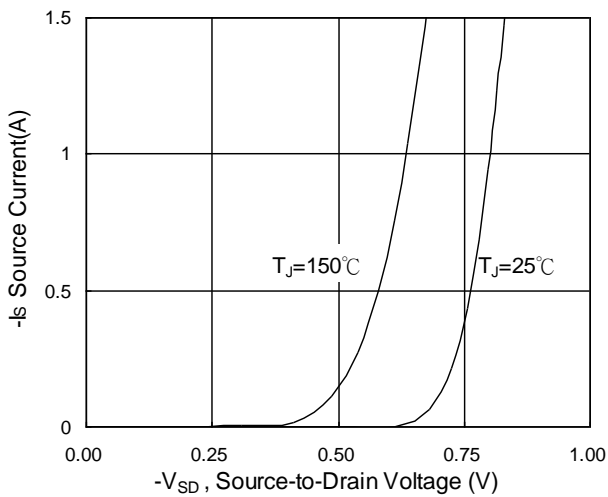
**Typical Characteristics**



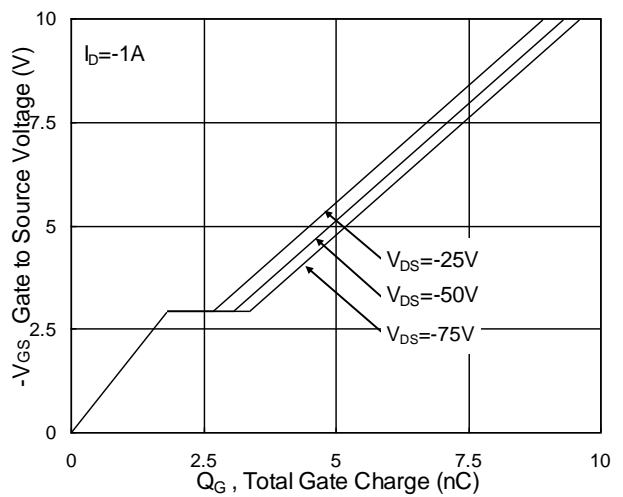
**Fig.1 Typical Output Characteristics**



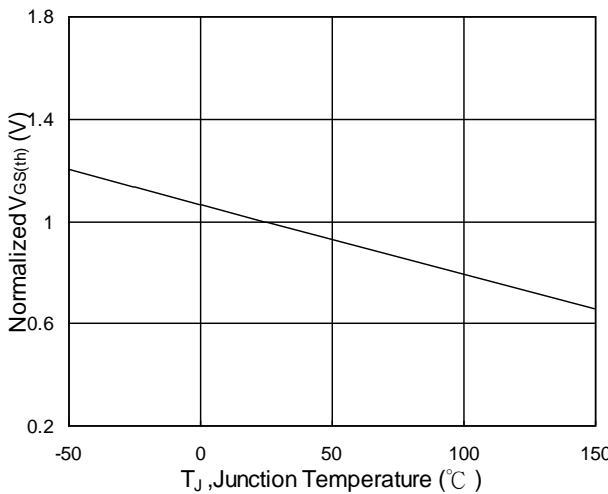
**Fig.2 On-Resistance vs. Gate-Source**



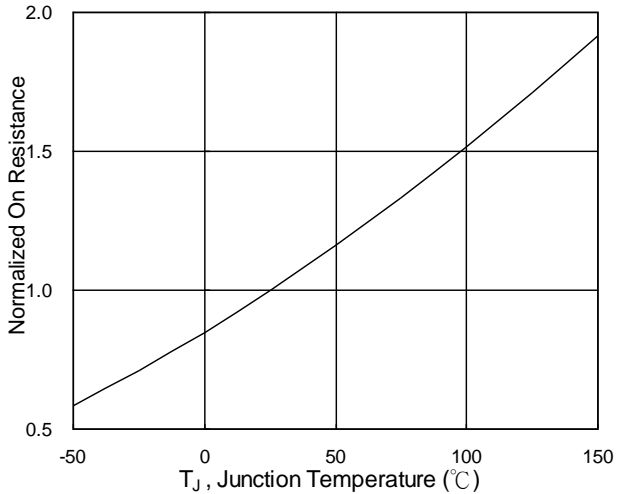
**Fig.3 Forward Characteristics Of Reverse**



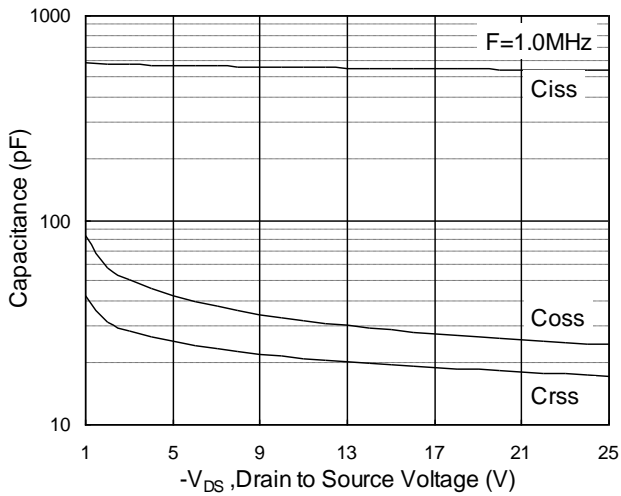
**Fig.4 Gate-Charge Characteristics**



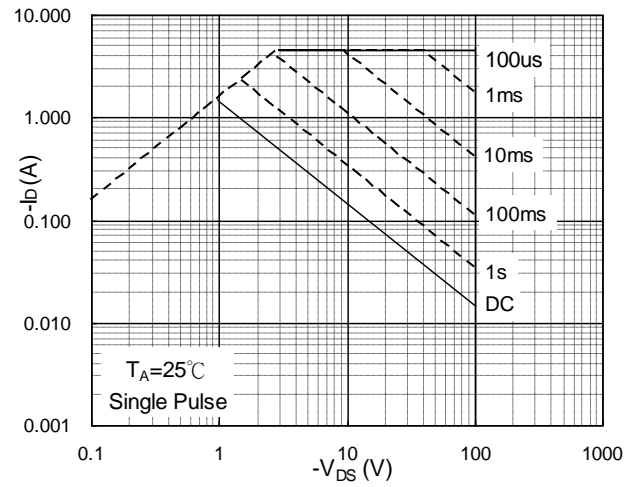
**Fig.5 Normalized  $V_{GS(th)}$  vs.  $T_J$**



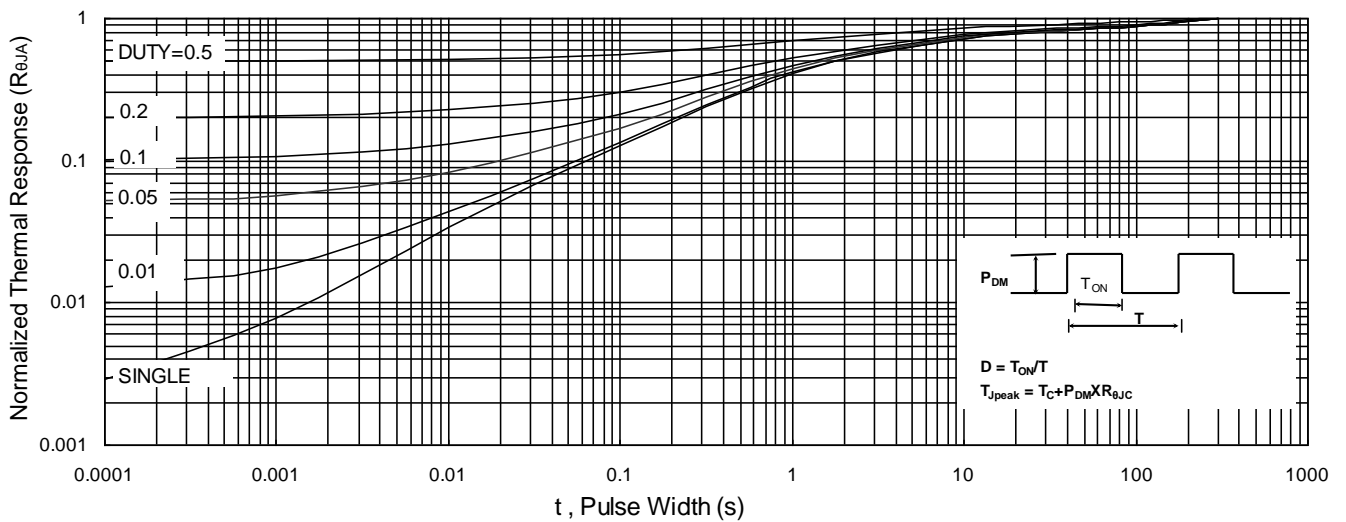
**Fig.6 Normalized  $R_{DSON}$  vs.  $T_J$**



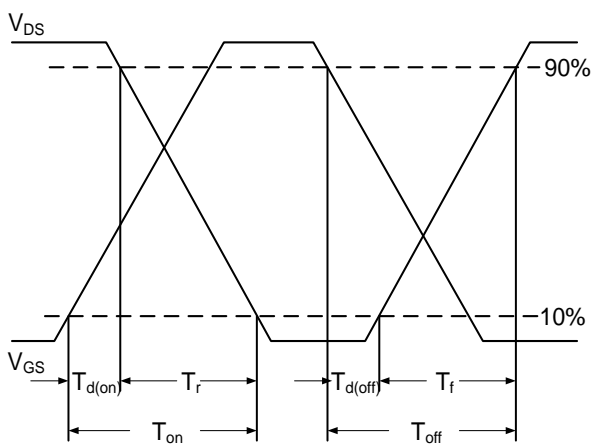
**Fig.7 Capacitance**



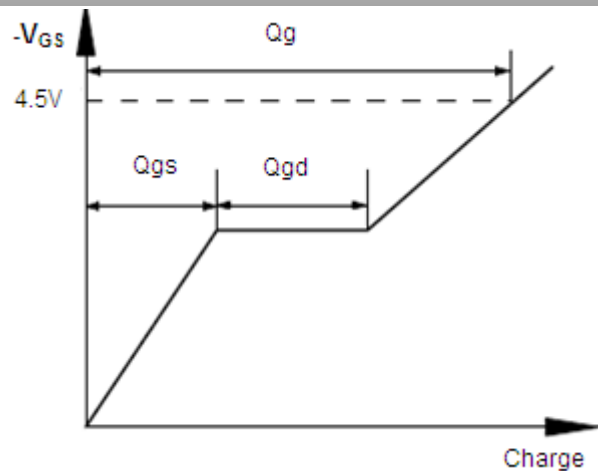
**Fig.8 Safe Operating Area**



**Fig.9 Normalized Maximum Transient Thermal Impedance**

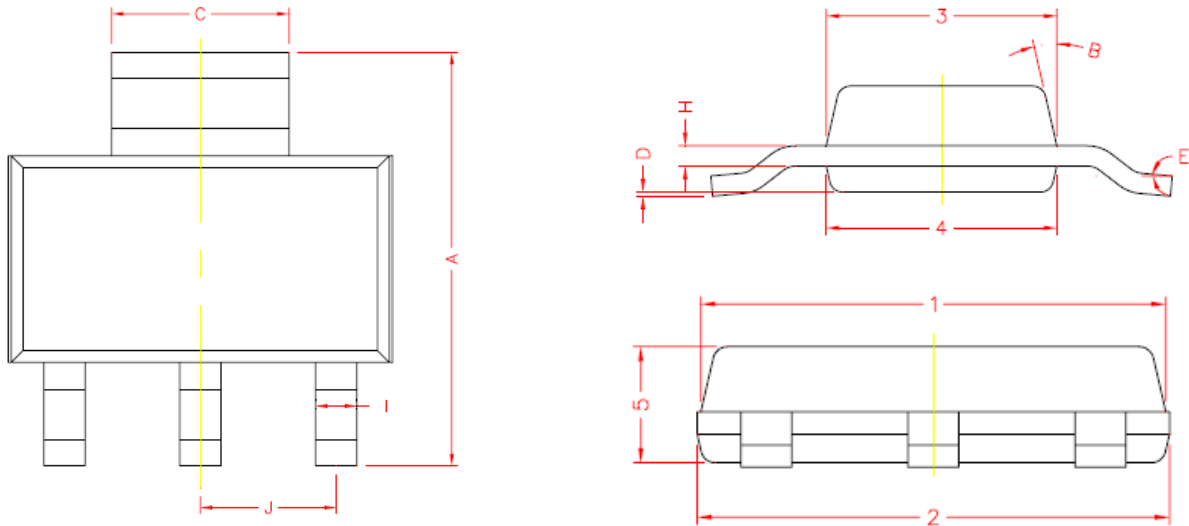


**Fig.10 Switching Time Waveform**



**Fig.11 Gate Charge Waveform**

**Package Information ( SOT-223 )**



REF.	DIMENSIONS	
	Millimeters	
	Min.	Max.
A	6.70	7.30
C	2.90	3.10
D	0.02	0.10
E	0°	10°
I	0.60	0.80
H	0.25	0.35
B	13° TYP.	
J	2.30 REF.	
1	6.30	6.70
2	6.30	6.70
3	3.30	3.70
4	3.30	3.70
5	1.40	1.80