

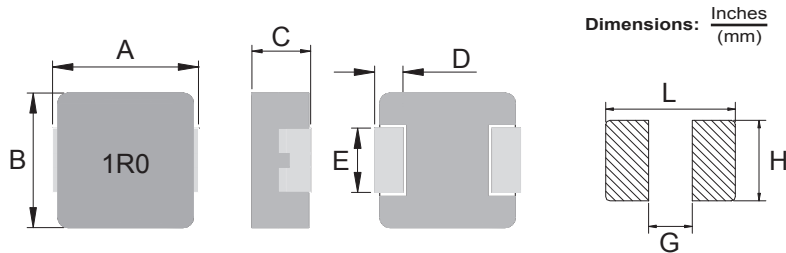

Power Choke High Current

PCHC320H



Dimensions: Inches (mm)

A(mm)	B(mm)	C(mm)	D(mm)	E(mm)
.138±.008	.126±.008	.071±.008	.028±.008	.047±.008
3.5±0.2	3.2±0.2	1.8±0.2	0.7±0.2	1.2±0.2

L(mm)	G(mm)	H(mm)
.161	.075	.057
4.1	1.9	1.45



Features

- Magnetically shielded construction
- Expanded operating temp range
- High Current
- Low DCR
- Suitable for pick and place
- Series is RoHS Compliant

Electrical

Inductance Range: 0.47µH to 10µH
Tolerance: ±20% Across entire series
Test Frequency: 100KHz, 1V
Operating Temp: -40°C to +125°C
Irms: Current at which ΔT=40°C temp rise without core loss.
Isat: Current at which Inductance drop is approximately 30%. The part temperature (ambient + temp rise) should not exceed 125°C under worst case operating conditions.

Resistance to Soldering Heat

Pre-Heat: 150°C, 1 minute.
Solder Composition: Sn96.5% Ag3% Cu0.5%
Solder Temp: 245°C ± 5°C
Immersion Time: 4 sec. ± 1 sec.
Depth: Completely cover the termination

Test Equipment

(L): HP4284A LCR meter or equivalent
DCR: CH16502, Agilent 33420A Micro-Ohmmeter

Physical

Packaging: 3000 pieces per 13 inch reel.
Marking: EIA Inductance Code/ Date Code

Allied Part Number	Inductance (µH) ±20% @ 0A	DCR (mΩ) Typ.@25°C	DCR (mΩ) Max@25°C	Irms (A) Typ.	Isat (A) Typ.
PCHC320H-R47M	0.47	19.7	23	7.0	9.0
PCHC320H-R65M	0.68	25.5	29	5.5	7.0
PCHC320H-1R0M	1.00	32	38	4.0	5.0
PCHC320H-1R5M	1.50	42	50	3.8	4.0
PCHC320H-2R2M	2.20	65	75	3.5	3.7
PCHC320H-3R3M	3.30	125	145	3.0	3.5
PCHC320H-4R7M	4.70	172	200	2.6	3.0
PCHC320H-5R6M	5.60	205	238	2.2	2.6
PCHC320H-6R8M	6.80	260	300	1.9	2.2
PCHC320H-8R2M	8.20	340	390	1.6	1.9
PCHC320H-101M	10.0	366	422	1.4	1.6

All specifications subject to change without notice.

Reflow Soldering

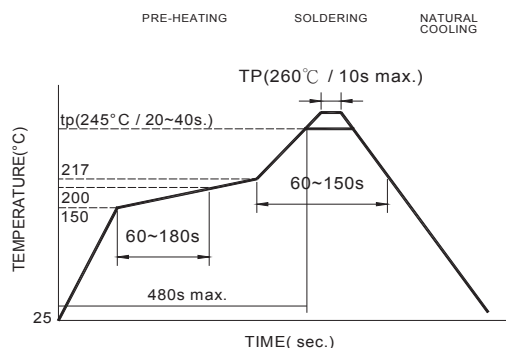

Reflow times: 3 times max.



Typical Performance Curves

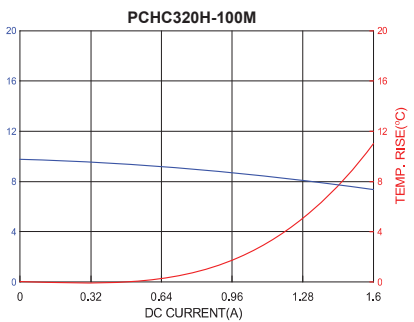
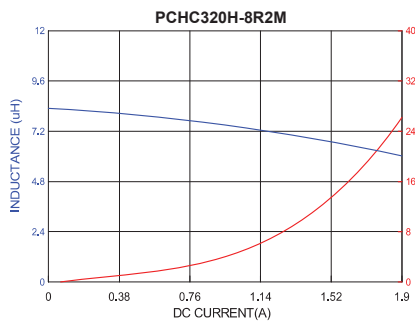
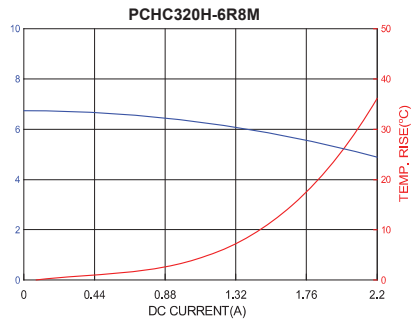
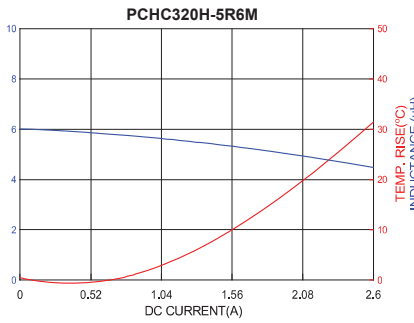
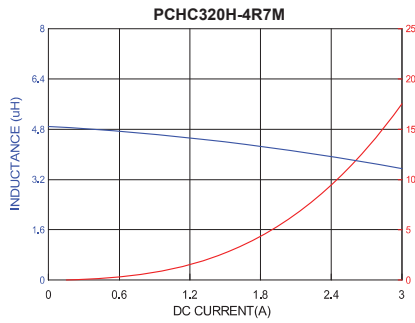
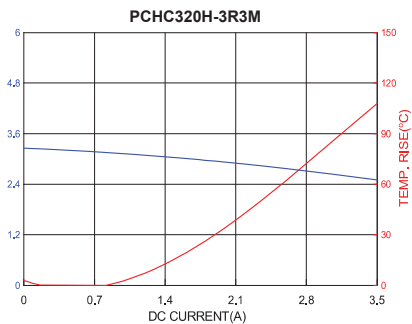
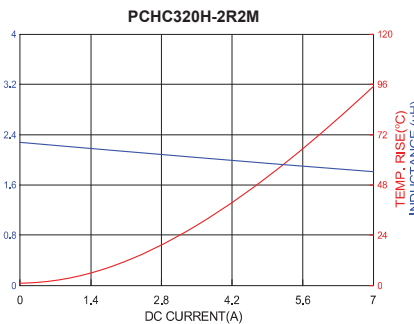
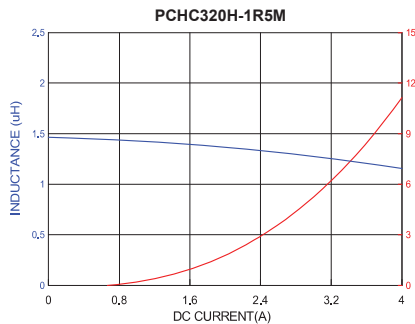
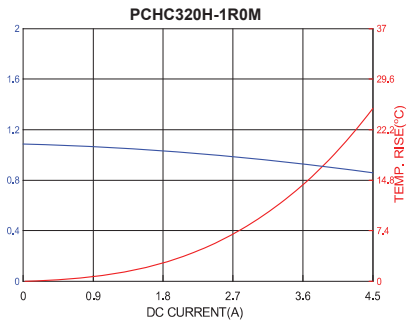
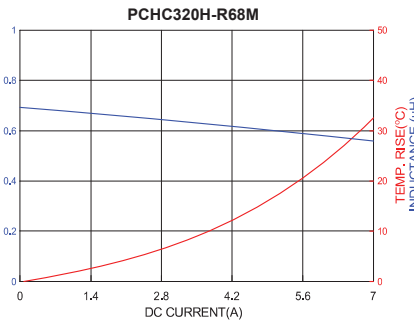
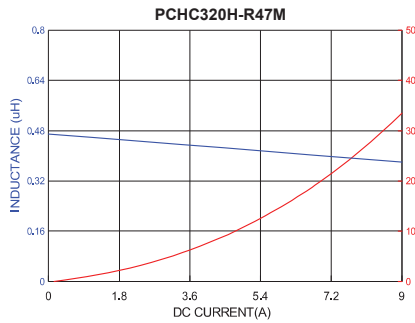

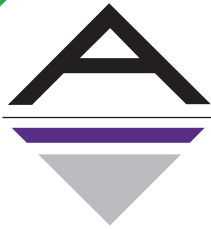

Packaging Information

Reel Dimension

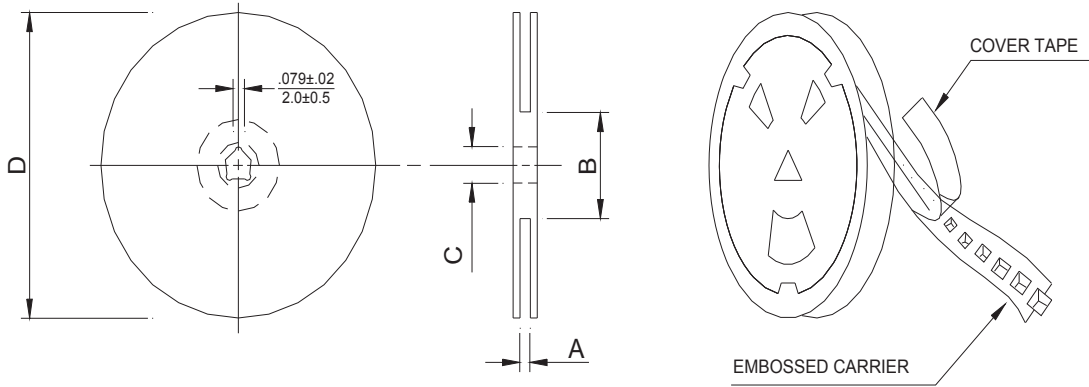

A	B	C	D
$.488 + .079 / - 0$	$3.94 \pm .079$	$.512 + .002 / - .008$	13.00
$12.4 + 2.0 / - 0$	100 ± 2.0	$13 + 0.5 / - 0.2$	330

Tape Dimension

