

# HFKA/HFKA-T

# AUTOMOTIVE RELAY

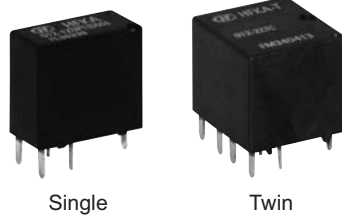

Single

Twin

### Typical Applications

Central door lock, Power doors and windows, Indicator lamp control, Seat adjustment, Sunroof motor control, Mirror adjustment, Wiper control

### Features

- 25A motor locked load
- Extremely small relay
- Change-over contact version
- Single and twin version available
- Coil wire insulation class H (180°C)
- HFKA-T (reflow soldering version) available
- RoHS & ELV compliant

## CHARACTERISTICS

Contact arrangement	1C (Single), 2C (Twin)
Voltage drop (initial) <sup>1)</sup>	Typ.: 50mV (at 10A) Max.: 250mV (at 10A)
Max. continuous current <sup>2)</sup>	25A (at 23°C, 1h)
Max. switching current	30A
Max. switching voltage <sup>3)</sup>	16VDC
Min. contact load	1A 6VDC
Electrical endurance	See "CONTACT DATA"
Mechanical endurance	1 x 10 <sup>7</sup> OPS (300OPS/min)
Initial insulation resistance	100MΩ (at 500VDC)
Dielectric strength <sup>4)</sup>	between contacts: 500VAC between coil & contacts: 500VAC
Operate time	Typ.: 2.5ms (at nomi. vol.) Max.: 10ms (at nomi. vol.)
Release time <sup>5)</sup>	Typ.: 1.2ms Max.: 10ms

Ambient temperature	HFKA: -40°C to 85°C HFKA-T: -40°C to 105°C
Vibration resistance <sup>6)</sup>	10Hz to 500Hz 49m/s <sup>2</sup>
Shock resistance <sup>6)</sup>	98m/s <sup>2</sup>
Termination	PCB <sup>7)</sup>
Construction	HFKA: Plastic sealed HFKA-T: Flux proofed
Unit weight	Single relay: Approx. 4g Twin relay: Approx. 8g

- Equivalent to the max. initial contact resistance is 100mΩ (at 1A 6VDC).
- For NO contacts, measured when applying 100% rated voltage on coil.
- See "Load limit curve" for details.
- 1min, leakage current less than 1mA.
- The value is measured when voltage drops suddenly from nominal voltage to 0 VDC and coil is not paralleled with suppression circuit.
- When energized, opening time of NO contacts shall not exceed 1ms, when non-energized, opening time of NC contacts shall not exceed 1ms, meantime, NO contacts shall not be closed.
- Since it is an environmental friendly product, please select lead-free solder when welding. The recommended soldering temperature and time is (250±3)°C, (5±0.3)s.

## CONTACT DATA <sup>3)</sup>

at 23°C

Load voltage	Load type <sup>2)</sup>		Load current A		On/Off ratio		Electrical endurance OPS	Contact material	Load wiring diagram
			1C, 2C		On s	Off s			
			NO	NC					
13.5VDC	Motor	Make <sup>1)</sup>	25	---	0.3	19.7	1 × 10 <sup>5</sup>	AgSnO <sub>2</sub>	
		Break	25	---					
	Simulate window operation	Make <sup>1)</sup>	25	---	0.2	4	1 × 10 <sup>5</sup>	AgSnO <sub>2</sub>	
		Stable	10	---					
		Break	25	---					
	Simulate motor operation	Make <sup>1)</sup>	27	---	0.02	1.8	1 × 10 <sup>5</sup>	AgSnO <sub>2</sub>	
		Transient	17	---					
		Break	8	---					



HONGFA RELAY

ISO9001, ISO/TS16949, ISO14001, OHSAS18001, IECQ QC 080000 CERTIFIED

2015 Rev. 1.00

- 1) Corresponds to the peak inrush current on initial actuation (motor).
- 2) When applied in flasher, a special silver alloy (AgSnO<sub>2</sub>) contact material should be used and the customer special code should be (170) as a suffix. Please heed the anode and cathode's request when wired, common terminal should connect with anode.
- 3) When the load requirement is different from content of the table above, please contact Hongfa for relay application support.

## COIL DATA

at 23°C

	Nominal voltage VDC	Pick-up voltage VDC max.	Drop-out voltage VDC min.	Coil resistance $x(1\pm 10\%)\Omega$	Power consumption W	Max. allowable overdrive voltage <sup>1)</sup> VDC	
						at 23°C	at 85°C
Standard	12	7.2	1.0	225	0.64	20	16
Low pick-up voltage	12	6.5	1.0	180	0.8	18	14

1) Max. allowable overdrive voltage is stated with no load applied.

## ORDERING INFORMATION

	<b>HFKA /</b>	<b>012</b>	<b>-1Z</b>	<b>S</b>	<b>P</b>	<b>T</b>	<b>C</b>	<b>(XXX)</b>
<b>Type</b>	HFKA: Standard HFKA-T: Reflow soldering version <sup>1)</sup>							
<b>Coil voltage</b>	<b>012:</b> 12VDC							
<b>Contact arrangement</b>	<b>1Z:</b> 1 Form C (Single version) <b>2Z:</b> 2 Form C (Twin version)							
<b>Construction</b>	<b>S:</b> Plastic sealed (HFKA) <sup>2)</sup> <b>Nil:</b> Flux proofed (HFKA-T)							
<b>Coil power</b>	<b>P:</b> Low pick-up voltage <b>Nil:</b> Standard							
<b>Contact material</b>	<b>T:</b> AgSnO <sub>2</sub>							
<b>Packing style</b>	<b>C:</b> Tape and reel packing <b>Nil:</b> Tube packing							
<b>Customer special code</b>	e.g. (170) stands for flasher load							

1) The structure of HFKA-T is only flux proof, the open vent hole is on the top of the relay.

2) Contact is recommended for suitable condition and specifications if water cleaning or surface process is involved in assembling relays on PCB.

## OUTLINE DIMENSIONS, WIRING DIAGRAM AND PC BOARD LAYOUT

Unit: mm

### Outline Dimensions

#### HFKA (Standard)

##### 1 Form C (Single version)

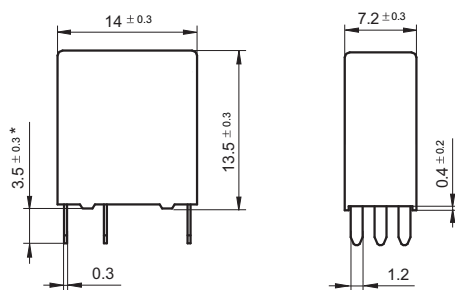

##### 2 Form C (Twin version)

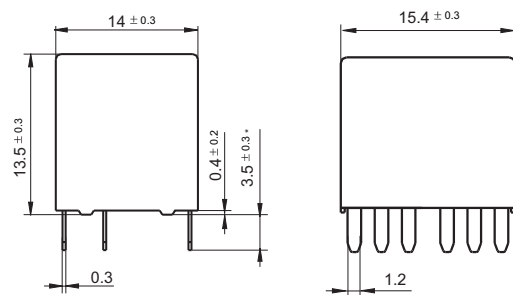

# OUTLINE DIMENSIONS, WIRING DIAGRAM AND PC BOARD LAYOUT

Unit: mm

## Outline Dimensions

### HFKA-T (Reflow soldering version)

#### 1 Form C (Single relay)

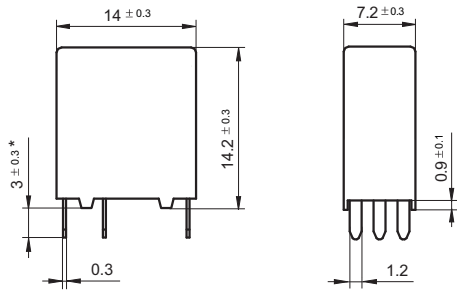

#### 2 Form C (Twin relay)

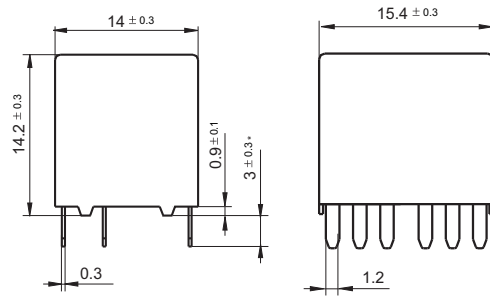

Remark: \* The additional tin top is max. 1mm.

## PCB Layout (Bottom view)

#### 1 Form C (Single relay)

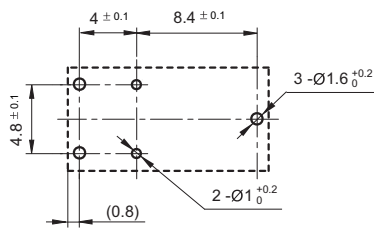

#### 2 Form C (Twin relay)

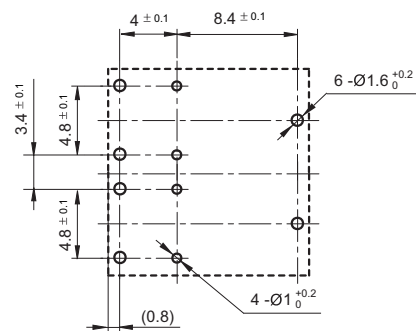

## Wiring Diagram (Bottom view)

#### 1 Form C (Single relay)

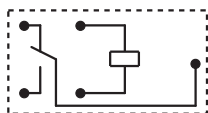

#### 2 Form C (Twin relay)

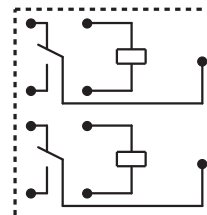

**Direction of Relay Insertion**

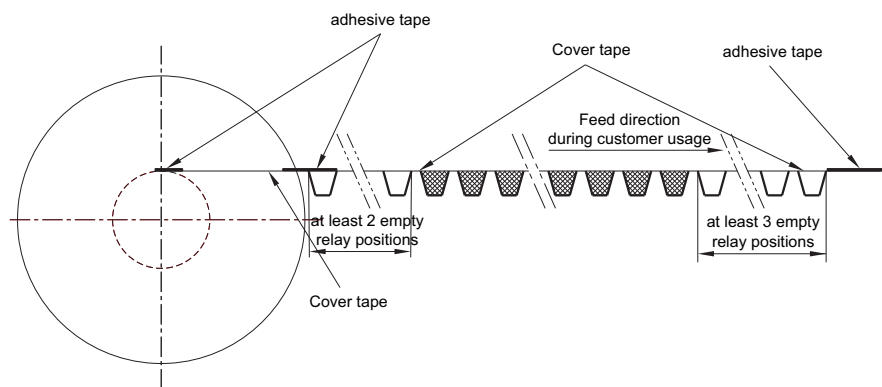
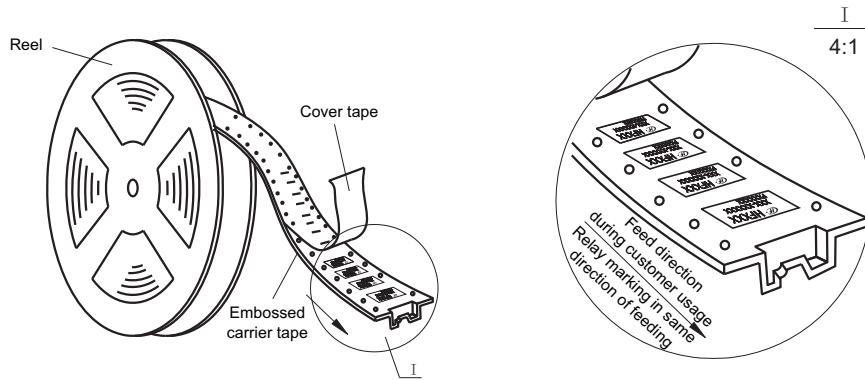

**Reel Dimensions**

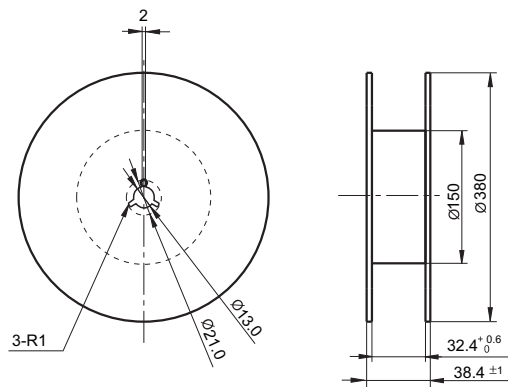

Tape Dimensions

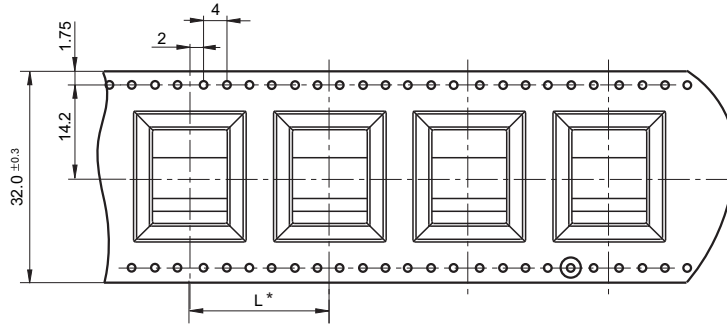

Remark: \* For Single relay, L is 20mm; for Twin relay, L is 28mm.

CHARACTERISTIC CURVES

1. Coil operating voltage range

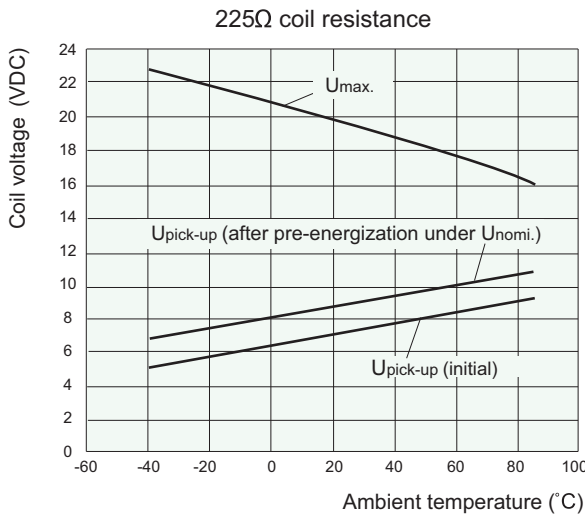

- 1) There should be no contact load applied when maximum continuous operation voltage is applied on coil.
- 2) The operating voltage is connected with coil pre-energized time and voltage. After pre-energized, the operating voltage will increase.
- 3) The maximum allowable coil temperature is 180°C. For the coil temperature rise which is measured by resistance is average value, we recommend the coil temperature should be below 170°C under the different application ambient, different coil voltage and different load etc.
- 4) If the actual operating coil voltage is out of the specified range, please contact Hongfa for further details.

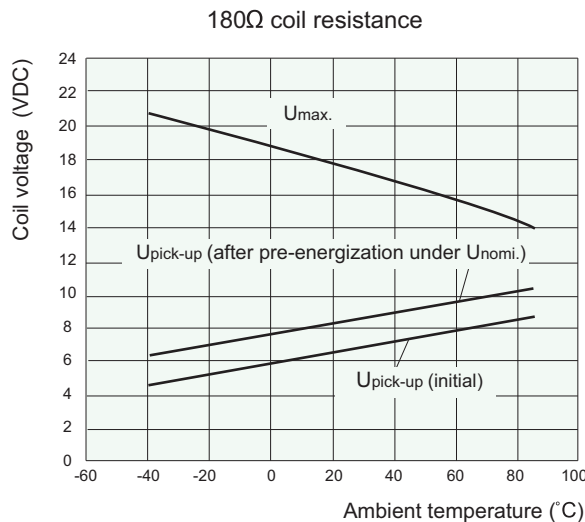

- 1) There should be no contact load applied when maximum continuous operation voltage is applied on coil.
- 2) The operating voltage is connected with coil pre-energized time and voltage. After pre-energized, the operating voltage will increase.
- 3) The maximum allowable coil temperature is 180°C. For the coil temperature rise which is measured by resistance is average value, we recommend the coil temperature should be below 170°C under the different application ambient, different coil voltage and different load etc.
- 4) If the actual operating coil voltage is out of the specified range, please contact Hongfa for further details.

## CHARACTERISTIC CURVES

### 2. Load limit curve (at 23°C)

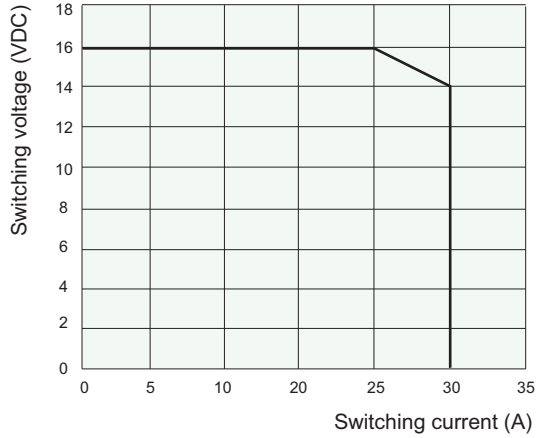

- 1) This chart takes NO contact, resistive load as example.
- 2) The load and electrical endurance tests are made according to "CONTACT DATA" parameters' table. If actual load voltage, current or operate frequency is different from "CONTACT DATA" table, please arrange corresponding tests for confirmation.

### 3. Reflow soldering, temperature on PCB board.

(Recommended soldering temperature, only for reflow soldering version)

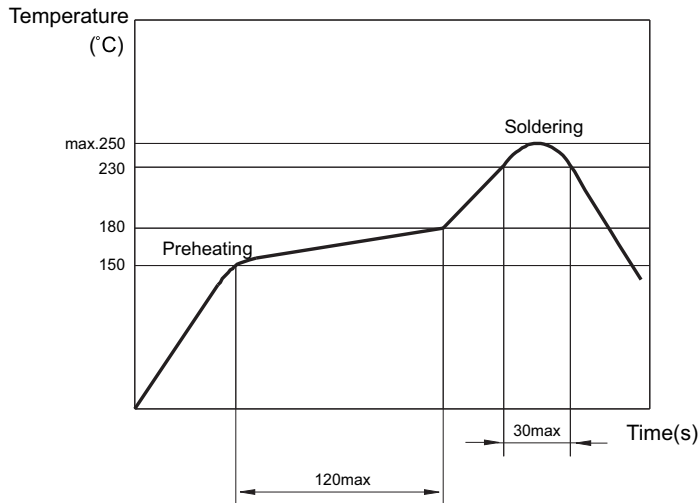

#### Disclaimer

The specification is for reference only. See to "Terminology and Guidelines" for more information. Specifications subject to change without notice. In case there is specific criterion (such as mission profile, technical specification, PPAP etc.) checked and agreed by and between customer and Hongfa, this specific criterion should be taken as standard regarding any requirement on Hongfa product.

We could not evaluate all the performance and all the parameters for every possible application. Thus the user should be in a right position to choose the suitable product for their own application. If there is any query, please contact Hongfa for the technical service. However, it is the user's responsibility to determine which product should be used only.

© Xiamen Hongfa Electroacoustic Co., Ltd. All rights of Hongfa are reserved.