

Application Note

Ceramic Quad Band Monopole Antenna

GSM850 or EGSM900

PCN1800, PCS1900 and WCDMA I

10 mm x 3.2 mm x 4 mm Ceramic Chip Antenna

Ground Cleared Under Antenna:
40 mm x 10 mm

Pulse Part Number: W3073

Version 1: GSM850, PCN1800, PCS1900 and WCDMA I
Version 2: EGSM900, PCN1800, PCS1900 and WCDMA I

Status

Author	MiJu	Version	1.0.0
Checked by		Date	22.02.2010
Approved by		Date	

Pulse Finland Oy

Takatie 6
90440 Kempele, Finland
Tel: +358 207 935 500

Domicile: Kempele
Business ID: 1933992-8
firstname.lastname@pulseeng.com

Table of Content

General Features and Applications	3
Terminal configuration and antenna dimensions.....	4
Test setup for electrical measurements	5
Electrical performance test results.....	8
Packing	15
Mechanical Outline	18
Contact information	19

Ceramic Chip Antenna

Ground Cleared Under Antenna

Features

- Low profile
- Compact size W x L x H (10 x 3.2 x 4 mm)
- Low weight (600 mg)
- Lead free materials
- Fully SMD compatible
- Lead free soldering compatible
- Tape and reel packing
- RoHS Compliant Product

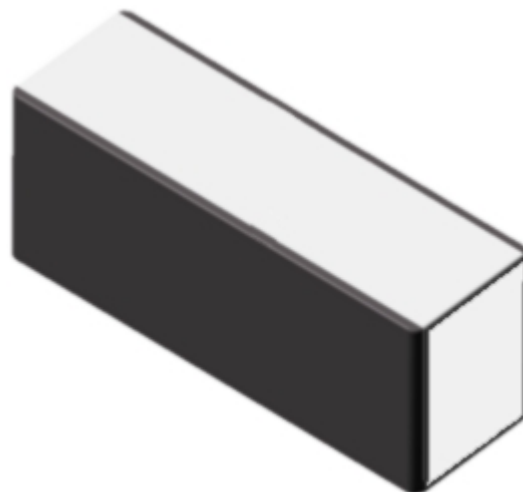

Applications

Version 1: GSM850, PCN1800, PCS1900 and WCDMA I- radios

Version 2: EGSM900, PCN1800, PCS1900 and WCDMA I- radios

Electrical specifications @ +25 °C

Note: Electrical characteristics depend on test board ground plane (GP) size, antenna positioning on GP and Ground Clearance area size.

Version 1: W3073 Ceramic Quad Band Monopole Antenna (Ground Cleared Under Antenna 40 mm x 10mm)

Typical performance (test board size 105 mm x 40 mm, PWB ground clearance area 40 mm x 10 mm)

10nH and 12nH series-inductors used for frequency tuning and 12nH shunt-inductor used for impedance matching.

Frequency Range [MHz]	3D Max Gain [dBi]	3D Efficiency [%] / [dB]	Return loss at band edges [dB]	Impedance [Ω]	Operating Temperature [°C]
824 - 894	-2.6 ; -1.76 (band edges) 0.4 (peak)	28/-5.5 ; 33/-4.8 (band edges) 51/-2.9 (peak)	-4.7 ; -5.9	50	-40 to +85
1710 – 1880	0.7 ; 2.3 (band edges) 2.3 (peak)	40/-4.0 ; 59/-2.3 (band edges) 59/-2.3 (peak)	-3.5 ; -6.7	50	-40 to +85
1850 – 1990	2.2 ; 1.6 (band edges) 2.5 (peak)	59/-2.3 ; 54/-2.7 (band edges) 59/-2.3 (peak)	-6.5 ; -5.9	50	-40 to +85
1920 - 2170	2.2 ; 0.9 (band edges) 2.2 (peak)	58/-2.3 ; 46/-3.4 (band edges) 58/-2.3 (peak)	-6.6 ; -3.3	50	-40 to +85

Version 2: W3073 Ceramic Quad Band Monopole Antenna (Ground Cleared Under Antenna 40 mm x 10mm)

Typical performance (test board size 105 mm x 40 mm, PWB ground clearance area 40 mm x 10 mm)

2pcs of 10nH series-inductors used for frequency tuning and 15nH shunt-inductor used for impedance matching.

Frequency Range [MHz]	3D Max Gain [dBi]	3D Efficiency [%] / [dB]	Return loss at band edges [dB]	Impedance [Ω]	Operating Temperature [°C]
880 - 960	-0.5 ; -1.8 (band edges) 1.0 (peak)	41/-3.8 ; 34/-4.7 (band edges) 60/-2.2 (peak)	-4.5 ; -3.8	50	-40 to +85
1710 – 1880	2.0 ; 2.8 (band edges) 2.9 (peak)	54/-2.7 ; 70/-1.6 (band edges) 70/-1.6 (peak)	-4.9 ; -9.1	50	-40 to +85
1850 – 1990	2.9 ; 2.5 (band edges) 2.9 (peak)	69/-1.6 ; 62/-2.1 (band edges) 71/-1.5 (peak)	-8.9 ; -8.0	50	-40 to +85
1920 - 2170	2.7 ; 2.3 (band edges) 2.8 (peak)	65/-1.9 ; 59/-2.3 (band edges) 67/-1.7 (peak)	-9.3 ; -4.4	50	-40 to +85

Pulse Finland Oy

Takatie 6
90440 Kempele, Finland
Tel: +358 207 935 500

Domicile: Kempele
Business ID: 1933992-8
firstname.lastname@pulseeng.com

Ceramic Chip Antenna

Terminal Configuration and Antenna Dimensions

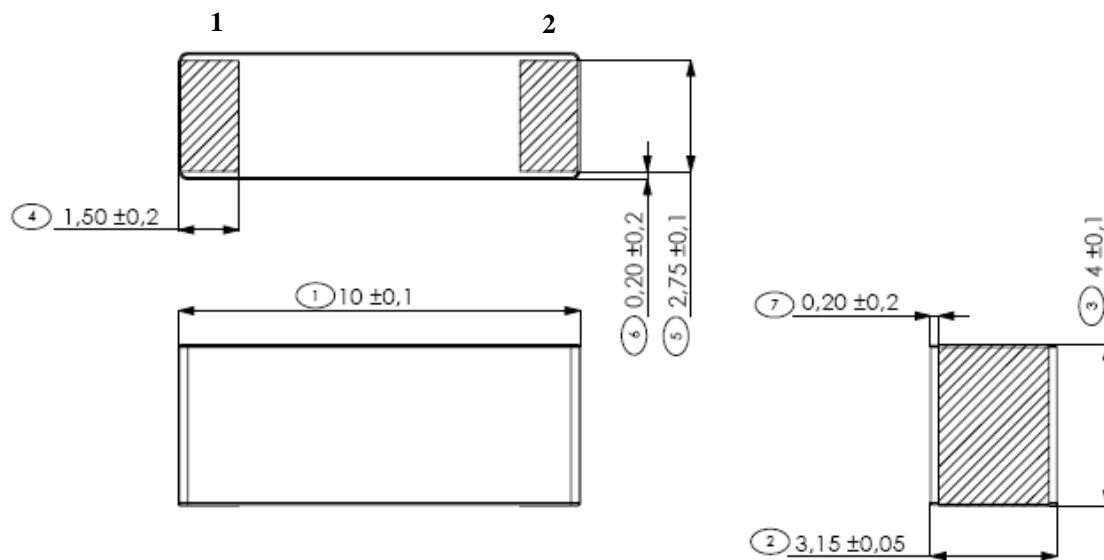

No.	Terminal Name	Terminal Dimensions
1	Feed	1.5 x 2.75 mm
2	Support pad	1.5 x 2.75 mm
Antenna is symmetrical and orientation on footprint can be rotated 180 degrees without change in performance		

Ceramic Chip Antenna

Test Setup for Electrical Measurements

Recommended test board- layout for electrical characteristic measurement. Test board outline size 105 x 40mm. Ground cleared under antenna 40mm x 10mm.

Version 1: GSM850, PCN1800, PCS1900 and WCDMA I

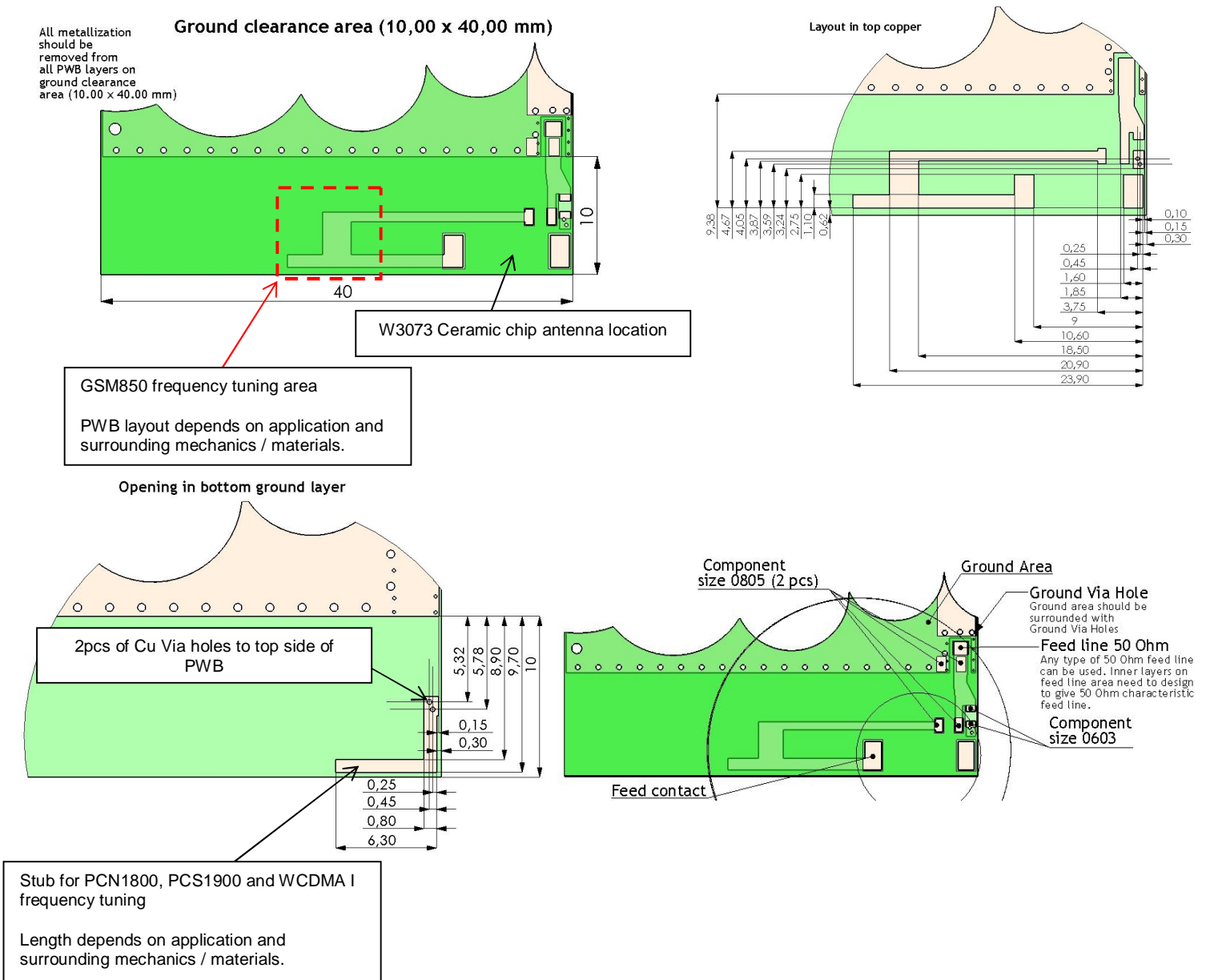

Version 2: EGSM900, PCN1800, PCS1900 and WCDMA I

All metallization should be removed from all PWB layers on ground clearance area (10,00 x 40,00 mm)

Ground clearance area (10,00 x 40,00 mm)

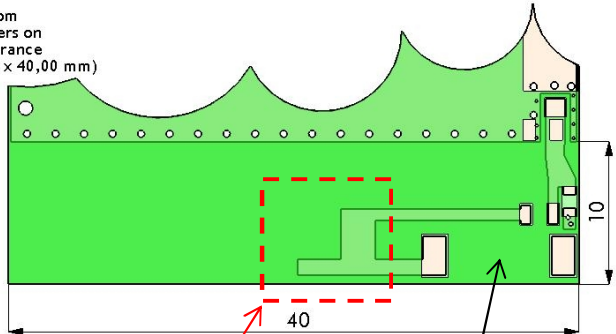

W3073 Ceramic chip antenna location

EGSM900 frequency tuning area
PWB layout depends on application and surrounding mechanics / materials.

Opening in bottom ground layers

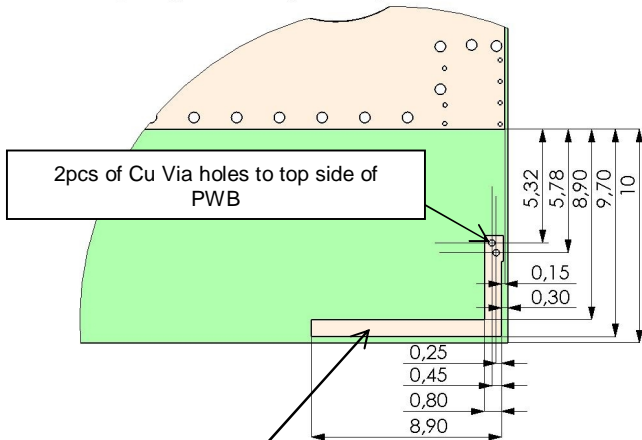

2pcs of Cu Via holes to top side of PWB

Stub for PCN1800, PCS1900 and WCDMA I frequency tuning
Length depends on application and surrounding mechanics / materials.

Pad dimensions in top copper

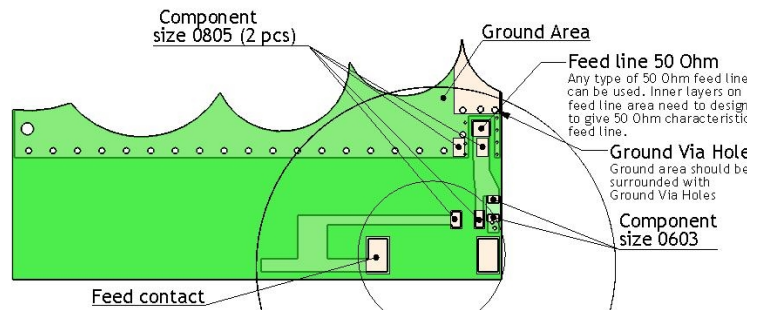
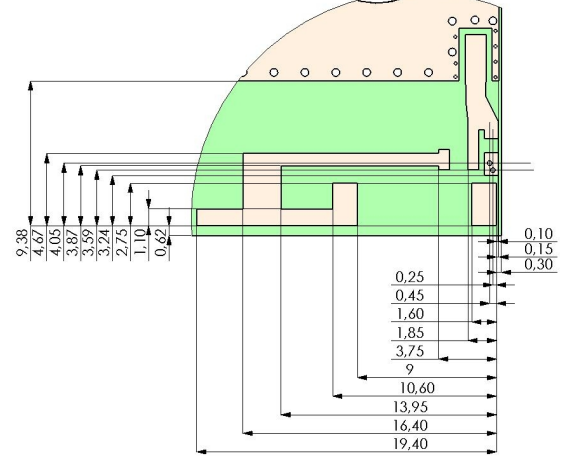

Recommended test board- layout for electrical characteristic measurement. Test board outline size 105 x 40mm. Ground cleared under antenna 40mm x 10mm.

3D- view of Test Setup

Version 1: GSM850, PCN1800, PCS1900 and WCDMA I

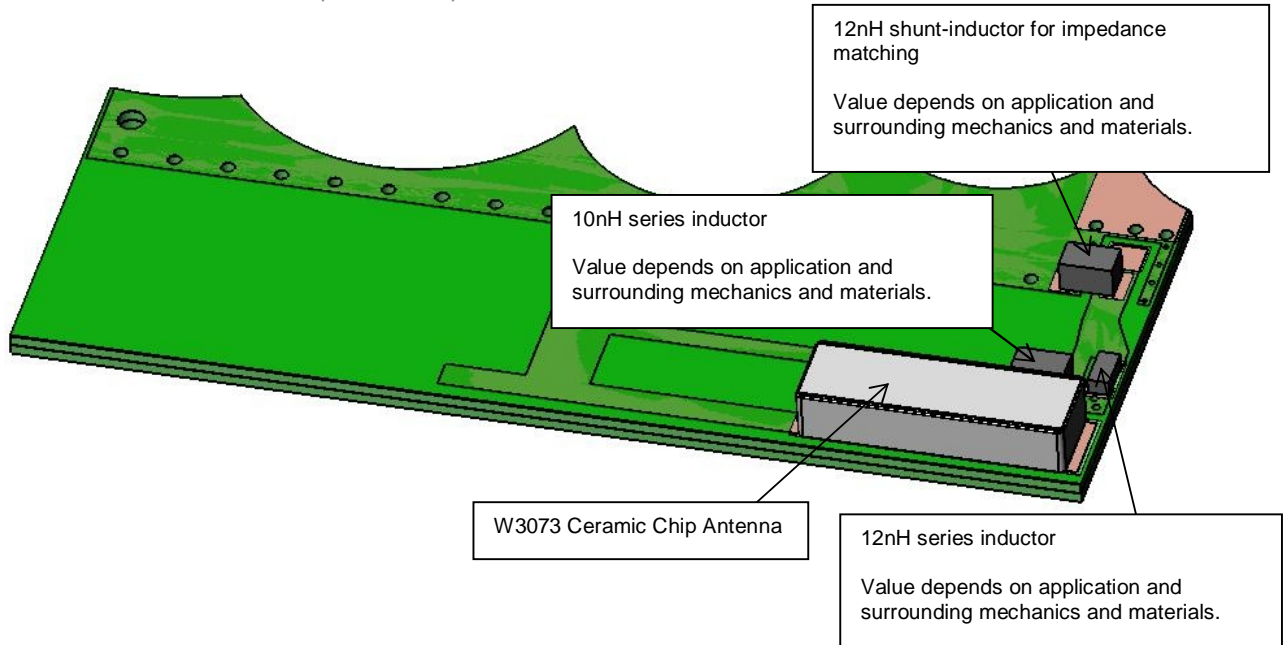

3D- view of Test Setup

Version 2: EGSM900, PCN1800, PCS1900 and WCDMA I

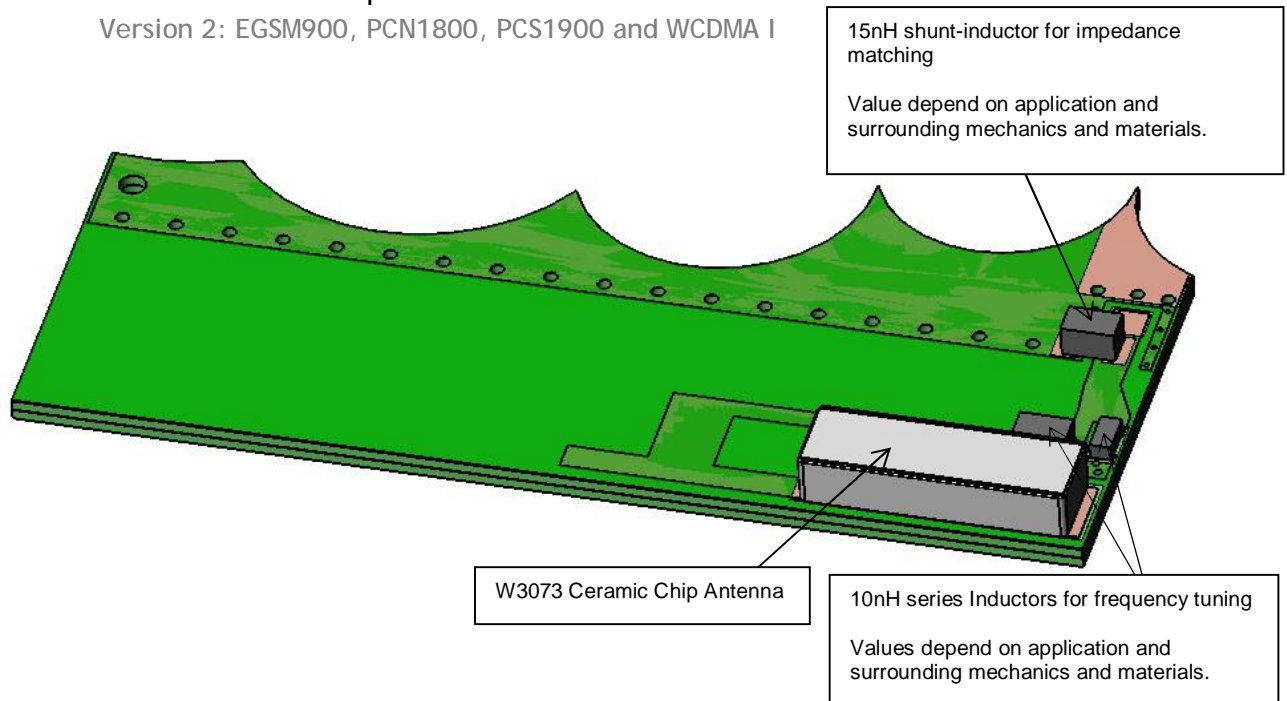

Ceramic Chip Antenna

Typical Electrical Characteristics (T=25 °C)

Measured with test board outline size 105 x 40mm. Ground cleared under antenna 40mm x 10mm.

Version 1: Typical Return Loss S11

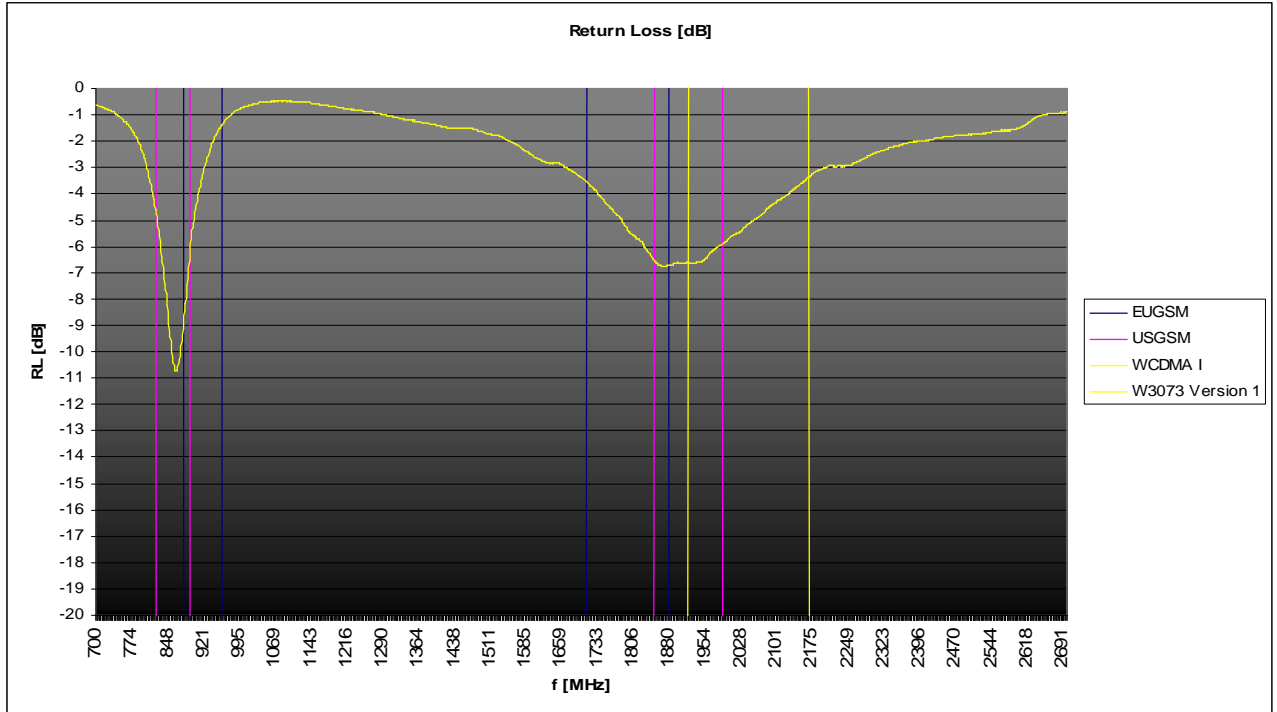

Version 2: Typical Return Loss S11

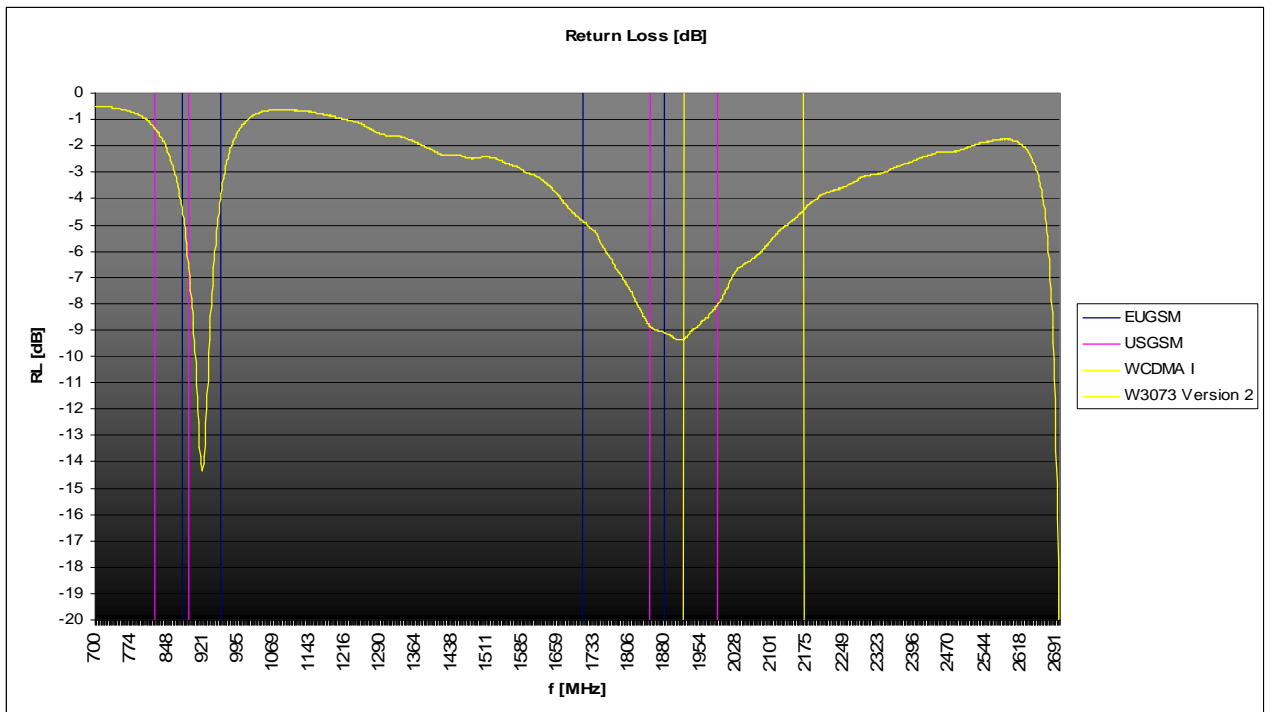

Version 1: Typical free Space Total Efficiencies [%]

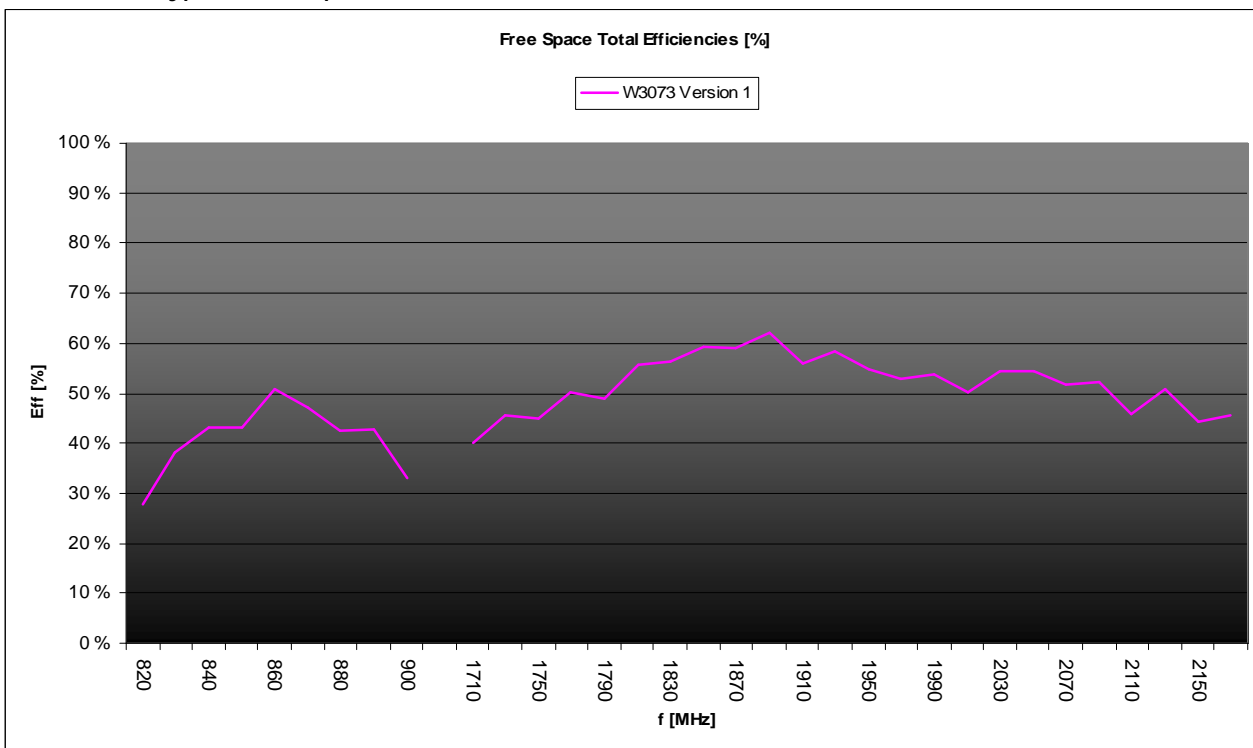

Version 2: Typical free Space Total Efficiencies [%]

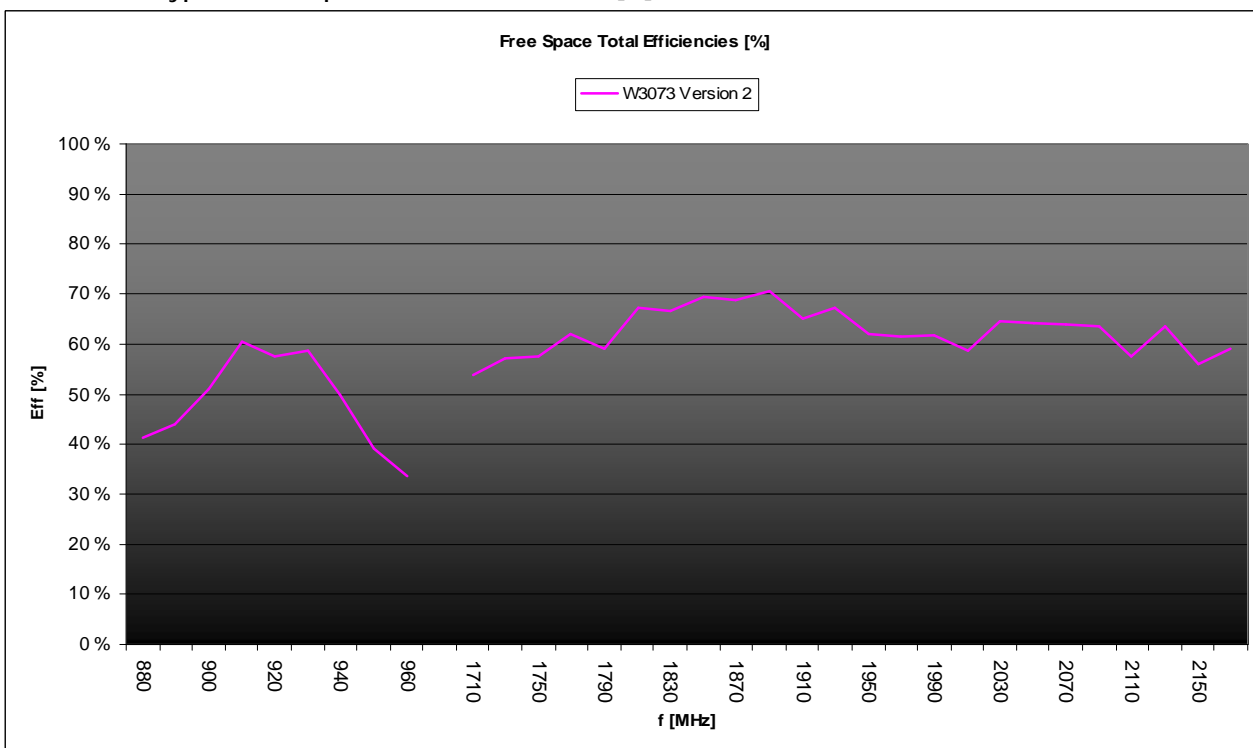

Version 1: Typical free Space Total Efficiencies [dB] and Maximum Gain [dBi]

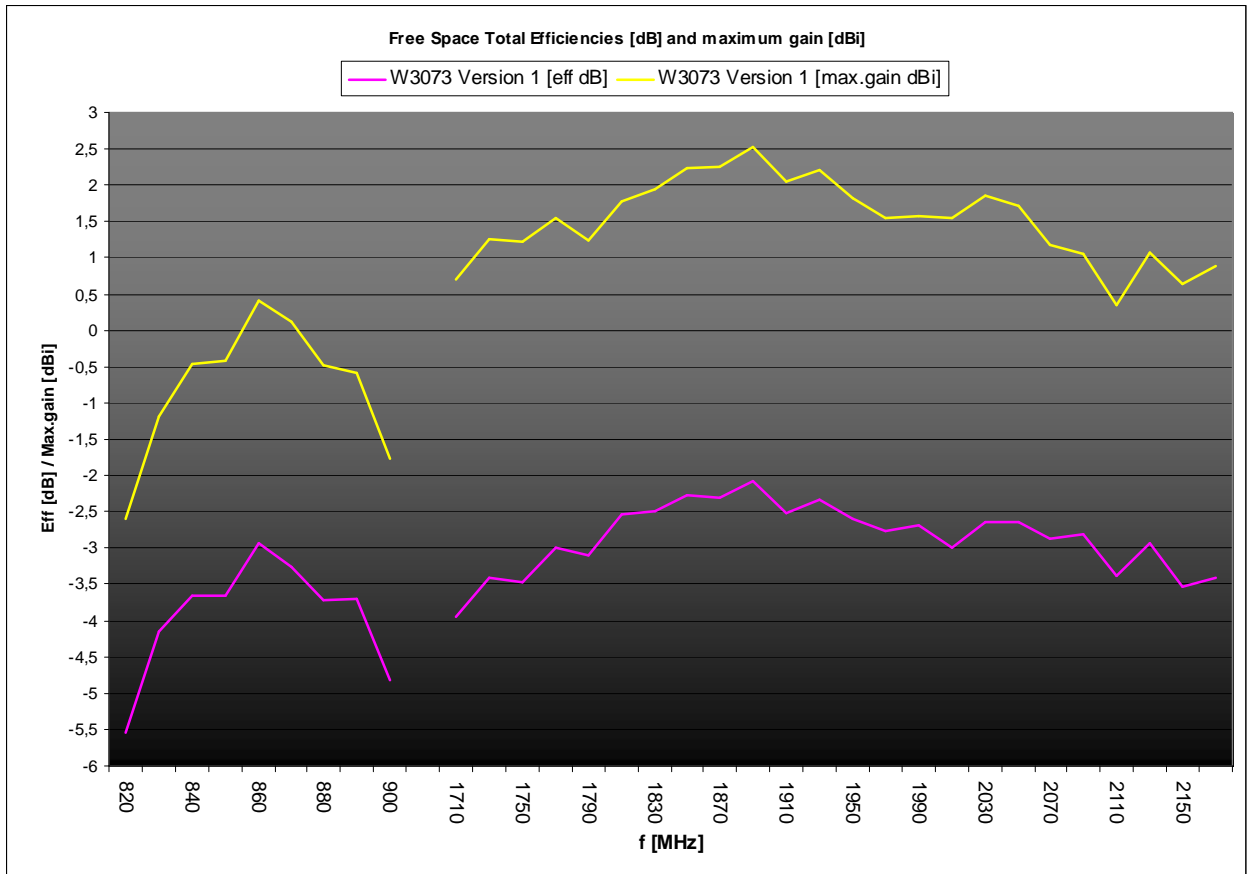

Version 2: Typical free Space Total Efficiencies [dB] and Maximum Gain [dBi]

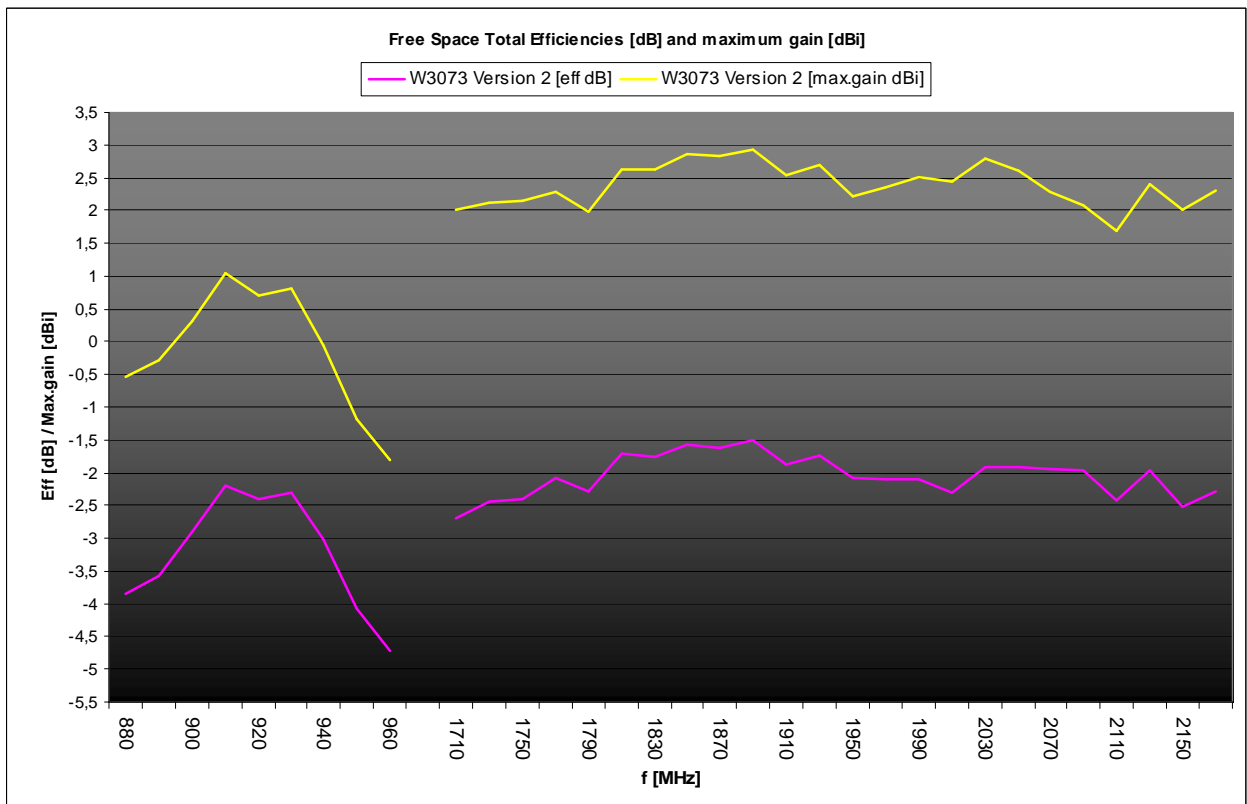

Ceramic Chip Antenna

Measured with test board outline size 105 x 40mm. Ground cleared under antenna 40mm x 10mm.

Version 1: Typical Free Space Radiation Patterns for GSM850 Band

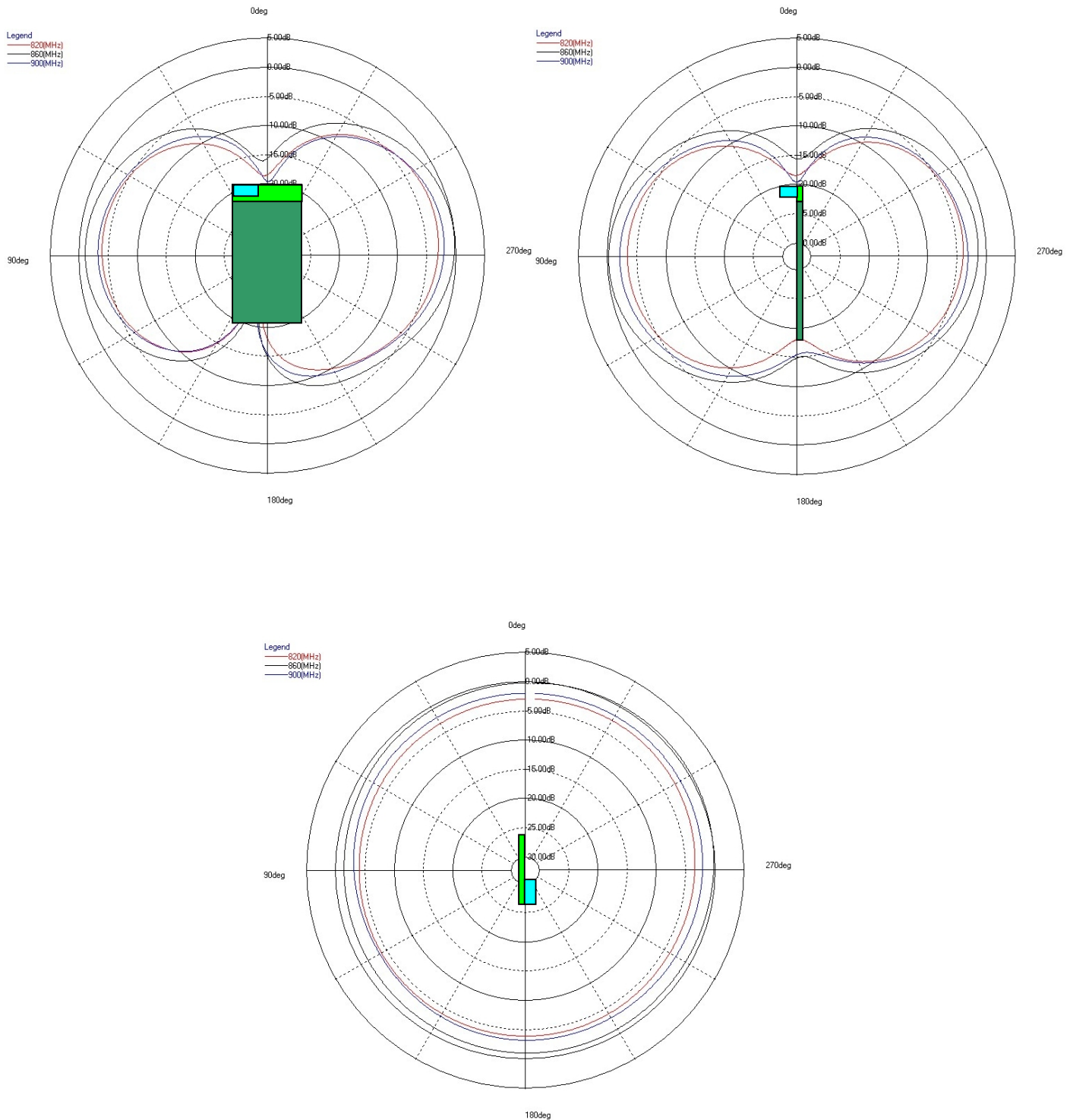

Version 1: Typical Free Space Radiation Patterns for PCN1800, PCS1900 and WCDMA I Bands

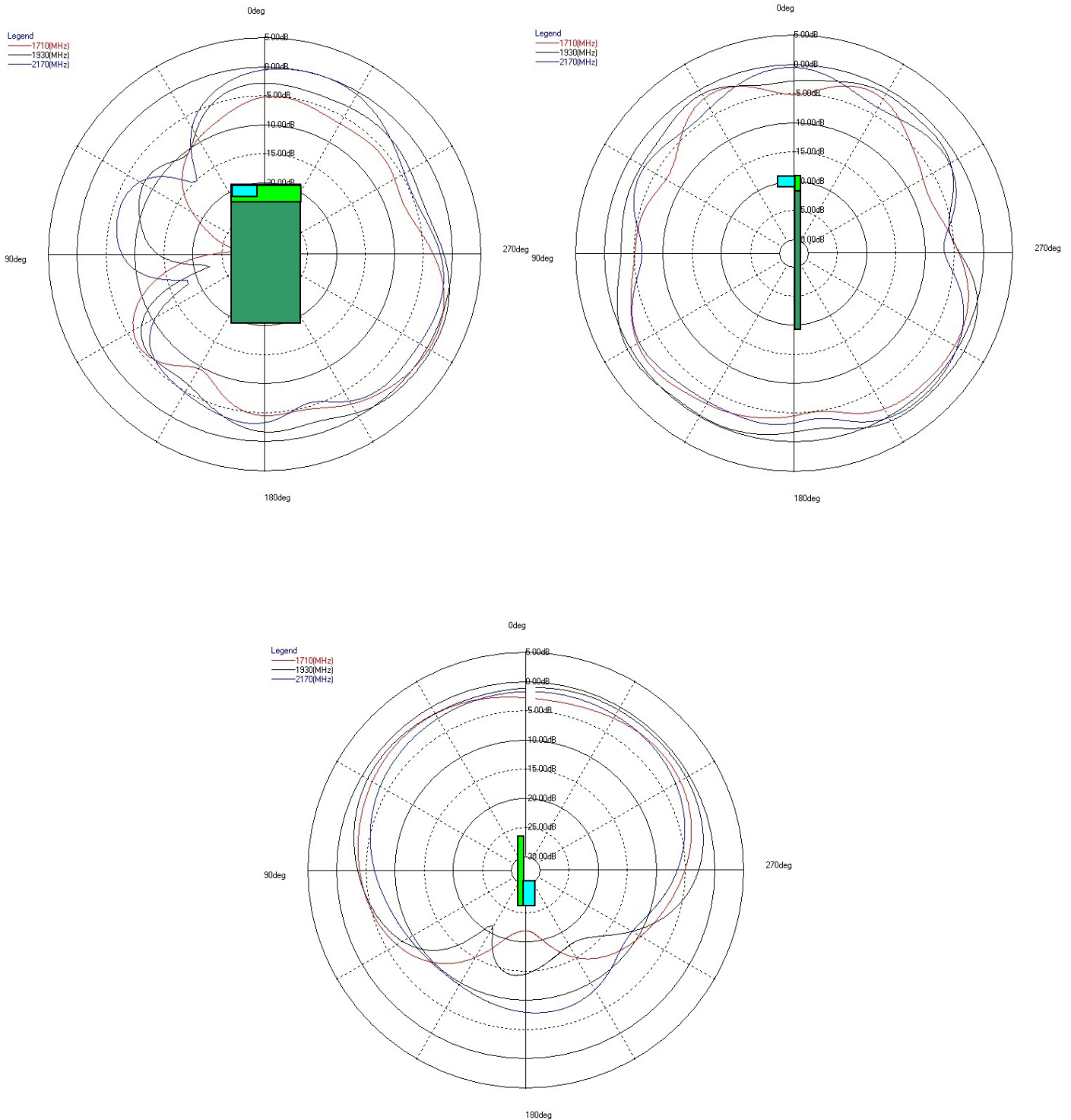

Ceramic Chip Antenna

Measured with test board outline size 105 x 40mm. Ground cleared under antenna 40mm x 10mm.

Version 2: Typical Free Space Radiation Patterns for EGSM900 Band

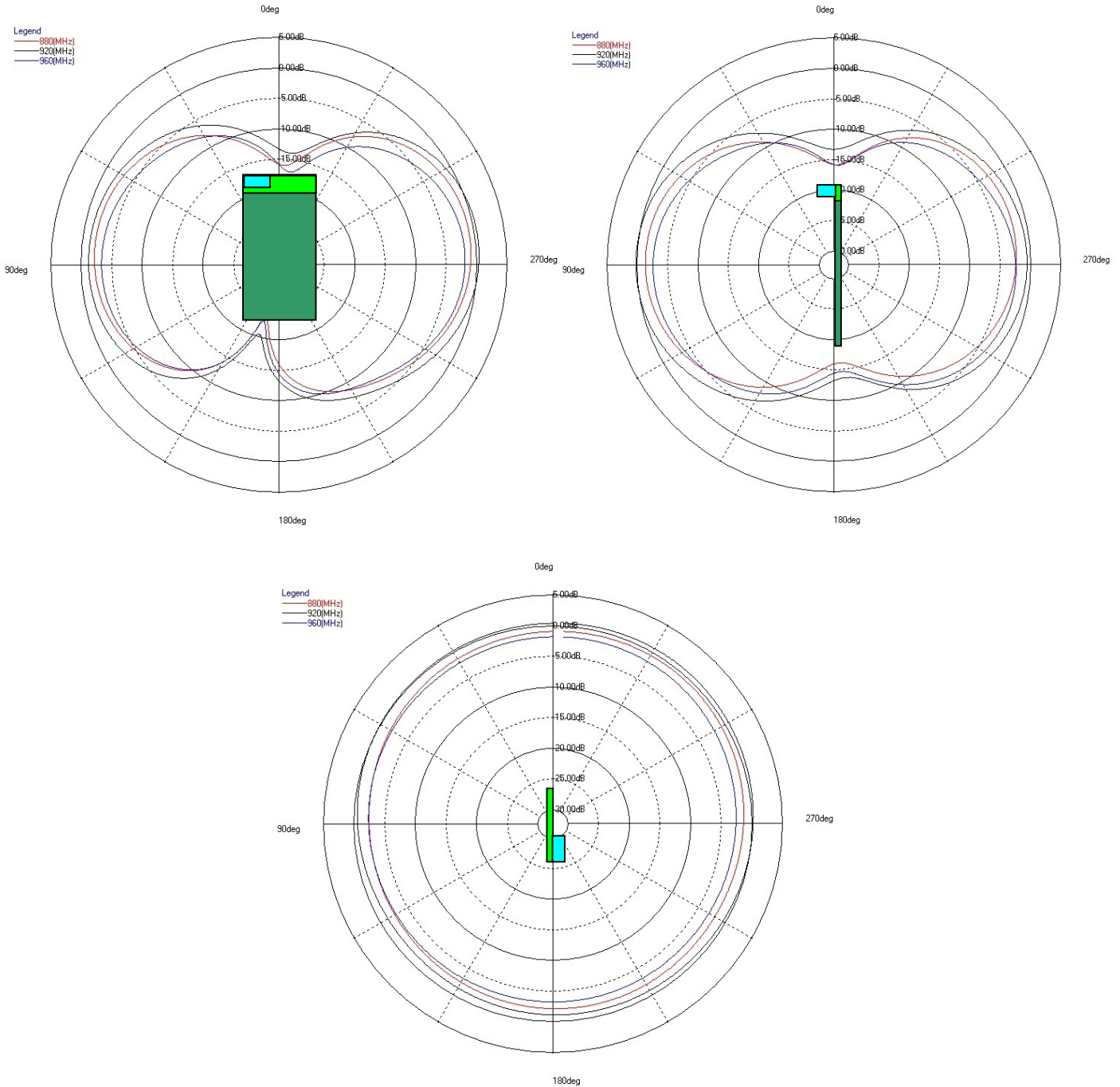

Version 2: Typical Free Space Radiation Patterns for PCN1800, PCS1900 and WCDMA I Bands

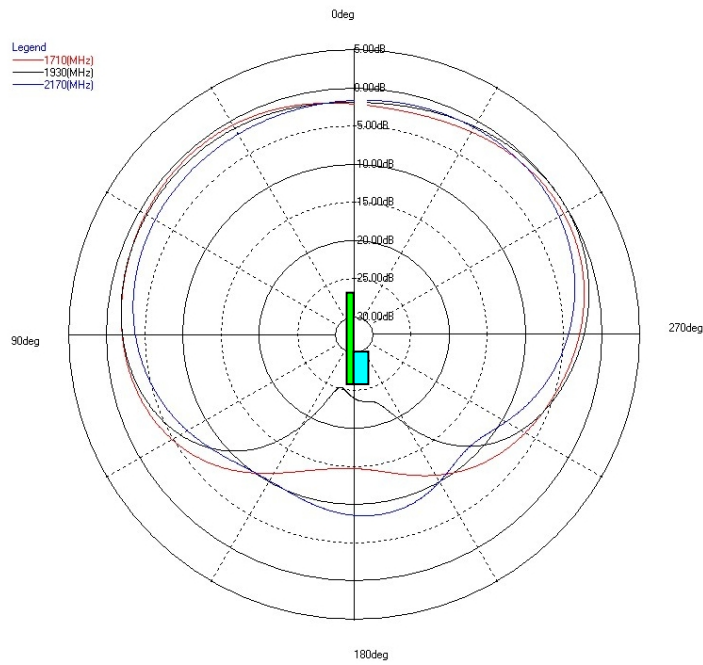
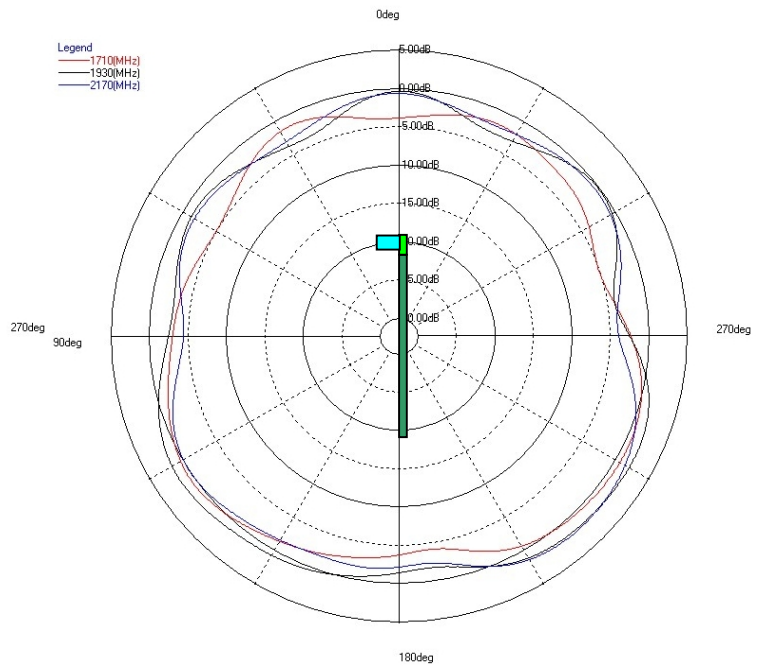
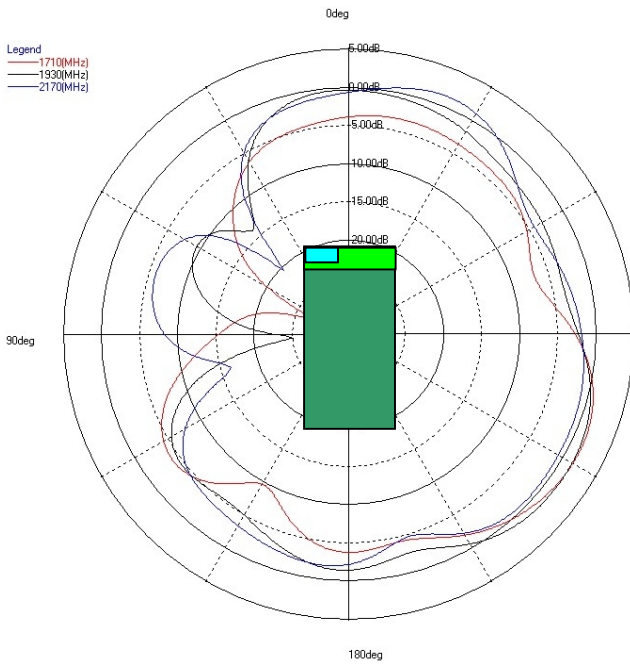

Ceramic Chip Antenna

Packing

General

Tape and reel packing is used. Carrier tape, reel and box dimensions are presented in following pictures.

Carrier Tape

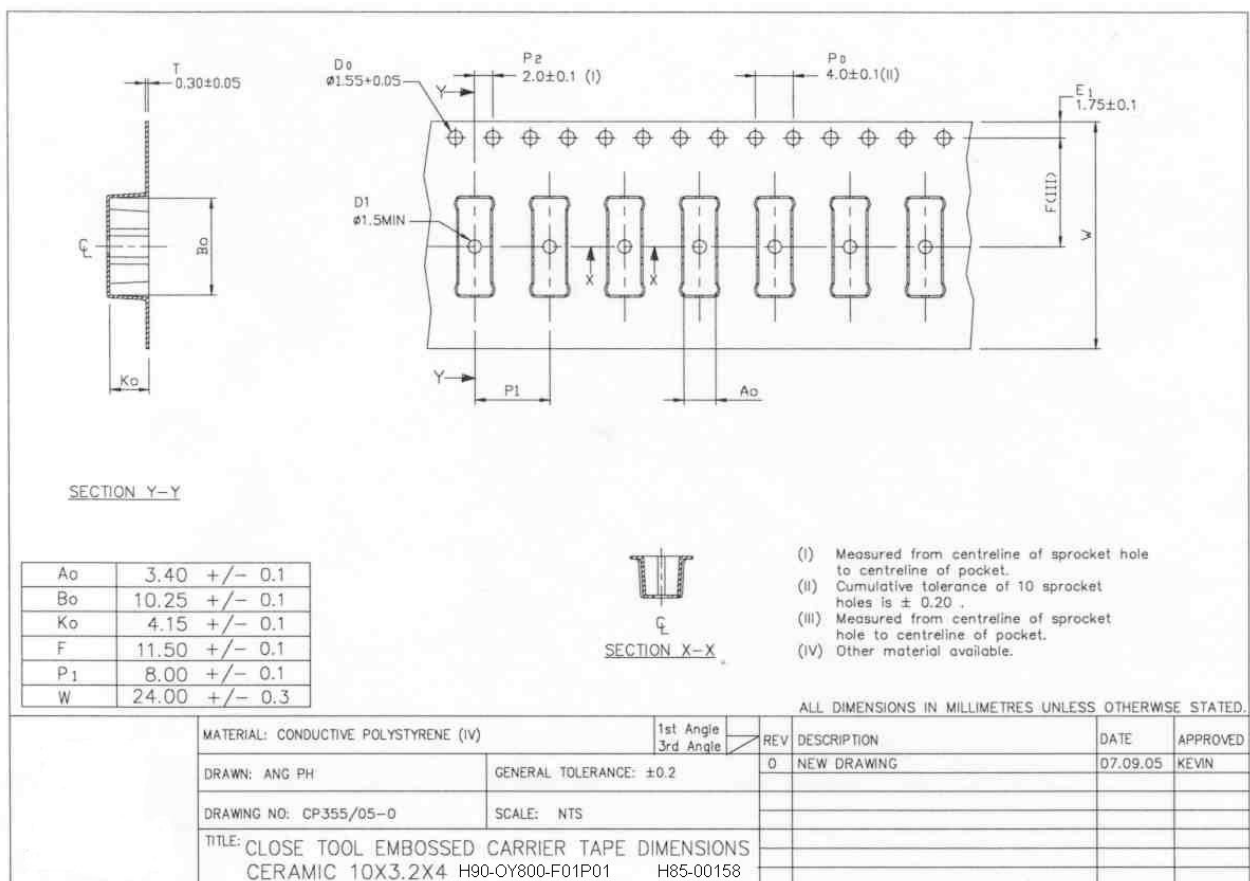

Block Orientation

Antenna soldering pads facing down to the bottom of the carrier tape.

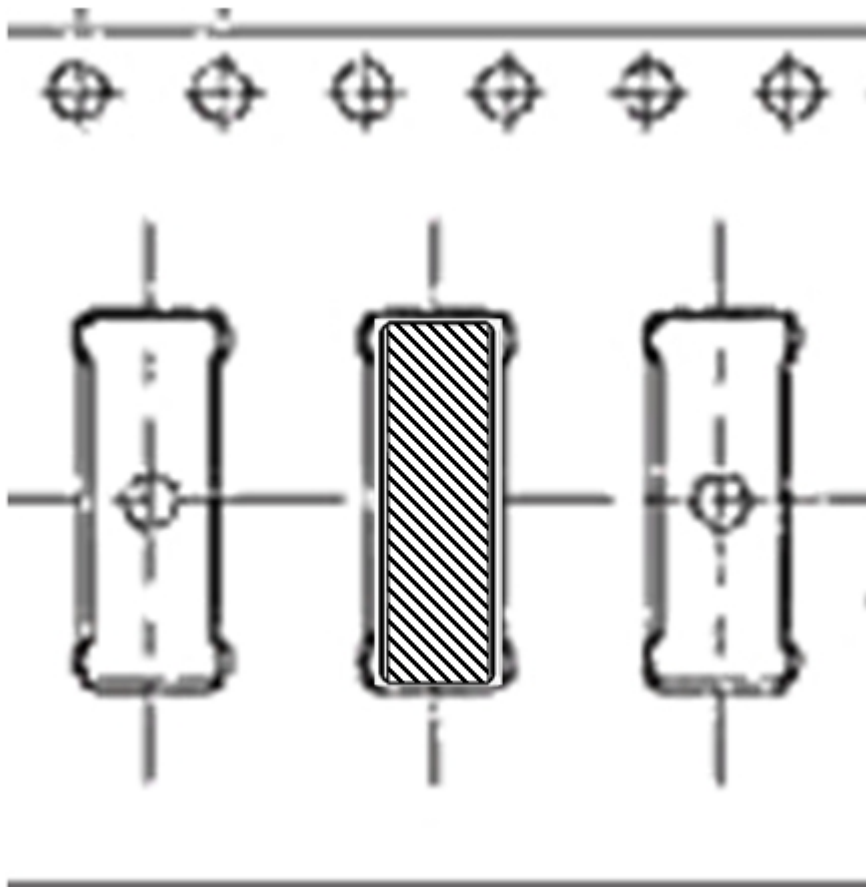

Packing Form

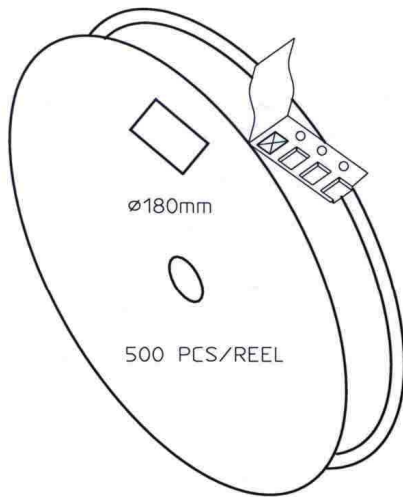

CARRIER TAPE H85-00158
width=24,00 depth=4.15
COVER TAPE H85-00159
width=21.20

LENGTH OF TAPE:

- Leader section: min 350 mm before component section
- Trailer section: min 40 mm after component section.

Empty part cavities at leader and trailer section of the tape must be sealed with top cover tape.

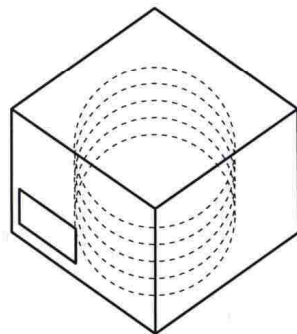

- BOX H85-00128 (182x182x125) 1 pcs
- LABEL 1 pcs/BOX
- REEL H85-00160 (D180, W28) 4 pcs
- REEL LABEL 1 pcs/REEL

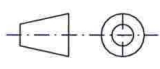
MATERIAL						
HANDLINGS						
		RATIO	DRWN	160107 PeHa	H	
			DGNER		G	
			CHKD		F	
			APPRD		E	
PRODUCT			APPRD BY		D	
H90-OY800-F01P01					C	
					B	
					A	
DENOMINATION			VERSION			MOD/DATE/NAME
PACKING FORM						

Ceramic Chip Antenna

Mechanical Outline

NOTE 4: Ag-metallization on hatched areas

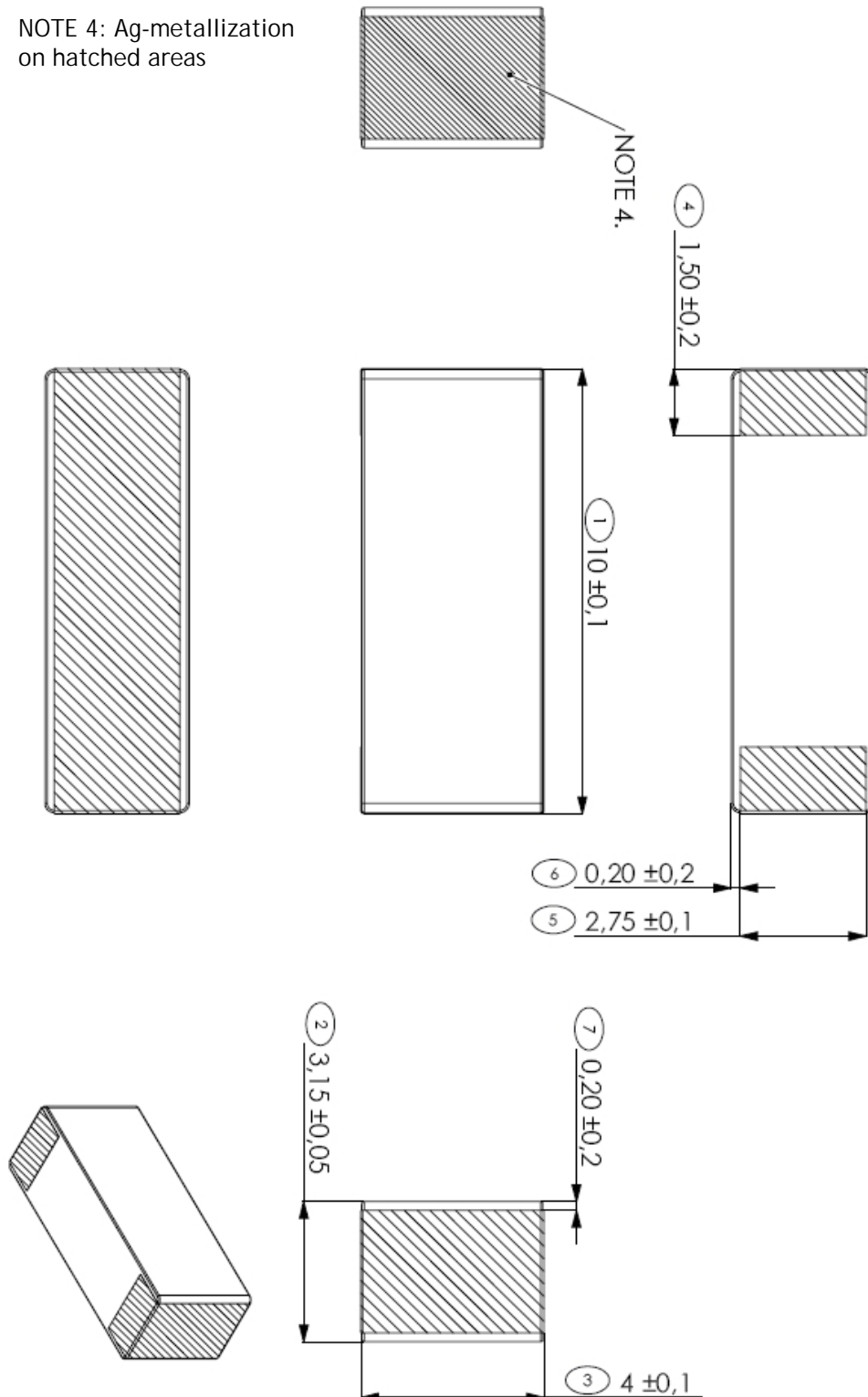

For More Information, please contact:

Pulse Finland Oy

Takatie 6

Fin-90440 Kempele

Finland

Tel. +358 207 935 500

Fax +358 207 935 501 (sales)

Domicile: Kempele

Business ID: 1933992-8

firstname.lastname@pulseeng.com

www.pulseeng.com/antennas

Pulse World Wide Headquarters

12220 World Trade Drive

San Diego, CA 92128

U.S.A

Tel. +1 858 674 8100

Fax +1 858 674 826

www.pulseeng.com

This is a "Preliminary" product application notes. Products mentioned on this application notes are in development and in the process of being qualified. These products are not fully released nor are they in production. Features, specifications and performance of products offered are subject to change without notice. Other brand and product names mentioned herein may be products and/or registered trademarks of their respective ones. For current info on this product, please contact the Pulse San Diego office.

© Copyright, 2006. Pulse Finland Oy. All rights reserved.

Pulse Finland Oy

Takatie 6

90440 Kempele, Finland

Tel: +358 207 935 500

Domicile: Kempele

Business ID: 1933992-8

firstname.lastname@pulseeng.com