

max. 285 m³/h

DC axial fans

Series 4400 119 x 119 x 38 mm



Highlights:

- Innovative impeller with winglets for low noise.
- Control inputs, alarm and speed signals available on request.
- High-speed version with 5000 rpm, standard models available with /2 and PWM.

General characteristics:

- Material: fibreglass-reinforced plastic. Impeller PA, housing PBT.
- Fully integrated electronic commutation.
- Protected against reverse polarity and locking.
- Connection via single strands AWG 24, TR 64. Bared and tin-plated.
- Air exhaust over struts. Direction of rotation clockwise, seen on rotor.
- Mass: 270 g.

Nominal data		Air flow		Nominal voltage	Voltage range	Sound pressure level	Sound power level	Sinter sleeve bearings Ball bearings	Power input	Nominal speed	Temperature range	Service life L ₁₀ (40 °C) ebm-papst standard	Service life L ₁₀ (T _{max}) ebm-papst standard	Life expectancy L ₁₀ Δ (40 °C) see P. 15	Curve	Specials
Type	m ³ /h	CFM	VDC	VDC	dB(A)	Bel(A)	■ / ■	Watts	RPM	°C	Hours	Hours	Hours	P. 110		
4412 L	150	88,3	12	7...14	37	5,0	■	2,5	2 700	-20...+70	67 500 / 35 000	140 000	1			
4412 M	184	108,3	12	7...14	42	5,3	■	4,2	3 300	-20...+70	65 000 / 32 500	130 000	2			
4412 N	205	120,7	12	7...14	46	5,6	■	5,5	3 650	-20...+70	62 500 / 30 000	120 000	3	/2		
4412 H	240	141,3	12	7...14	50	6,0	■	8,9	4 300	-20...+70	57 500 / 27 500	110 000	4	/2		
4412 /2 HHP	285	167,7	12	7...14,5	55	6,4	■	13,0	5 000	-20...+70	50 000 / 25 000	100 000	5	/2		
4414 L	150	88,3	24	18...28	37	5,0	■	2,5	2 700	-20...+70	67 500 / 35 000	140 000	1			
4414 M	184	108,3	24	18...28	42	5,3	■	4,0	3 300	-20...+70	65 000 / 32 500	130 000	2			
4414 N	205	120,7	24	18...28	46	5,6	■	5,2	3 650	-20...+70	62 500 / 30 000	120 000	3			
4414 H	240	141,3	24	18...28	50	6,0	■	8,6	4 300	-20...+70	57 500 / 27 500	110 000	4	/2		
4414 HH	285	164,8	24	16...28	55	6,4	■	14,0	5 000	-20...+70	50 000 / 25 000	100 000	5			
4414 /2 HHP	285	167,7	24	18...28	55	6,4	■	12,0	5 000	-20...+70	50 000 / 25 000	100 000	5	/2		
4418 L	150	88,3	48	36...60	37	5,0	■	2,5	2 700	-20...+70	67 500 / 35 000	140 000	1			
4418 M	184	108,3	48	36...60	42	5,3	■	4,2	3 300	-20...+70	65 000 / 32 500	130 000	2			
4418 N	205	120,7	48	36...60	46	5,6	■	5,2	3 650	-20...+70	62 500 / 30 000	120 000	3			
4418 H	240	141,3	48	36...60	50	6,0	■	8,6	4 300	-20...+70	57 500 / 27 500	110 000	4	/2		
4418 /2 HHP	285	167,7	48	36...60	55	6,4	■	13,5	5 000	-20...+70	50 000 / 25 000	100 000	5	/2		

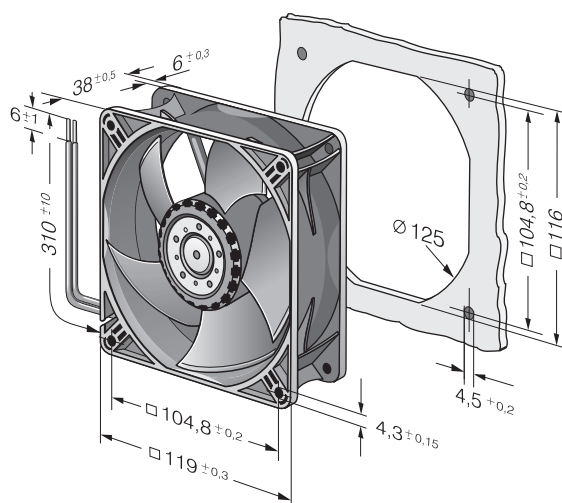
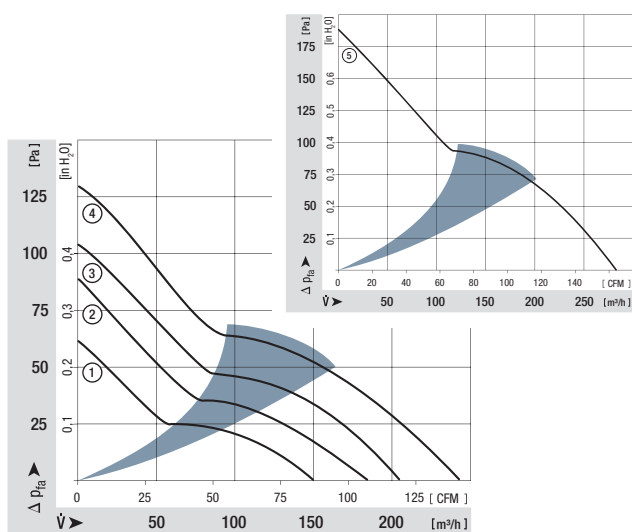

Speed signal /12

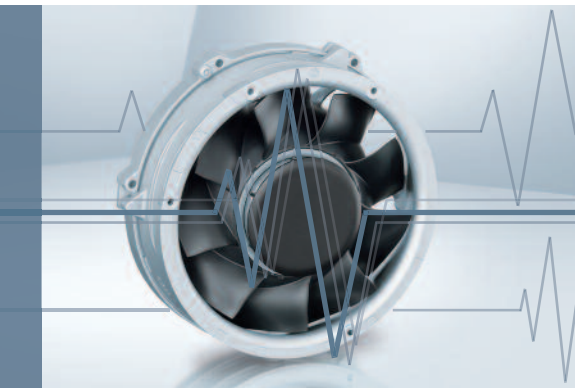

- Speed-proportional, square-wave signal for external monitoring of the fan motor speed
- 2, 3, or 6 pulses per revolution
- TTL-compatible
- Integrated pull-up resistor
- Connection via separate cable
- The sensor signal also serves as a major comparison variable for setting and maintaining the setpoint speed for interactive or controlled cooling with one or more interconnected fans.

Electrical hookup

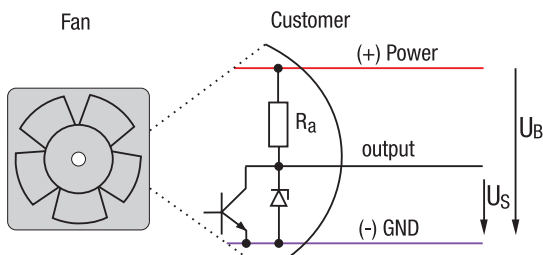

All voltages measured to ground.

Signal output voltage

Standard signal for all models (exceptions see below)

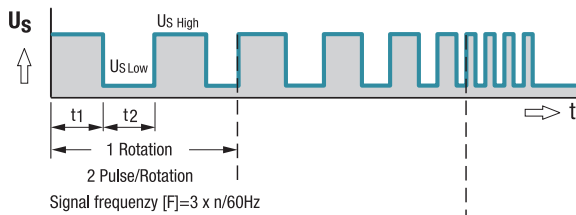

For multi options control input and 4100 NH7 and NH8

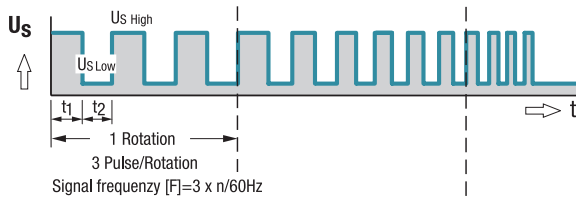

All TD Fans e.g. 6300 TD

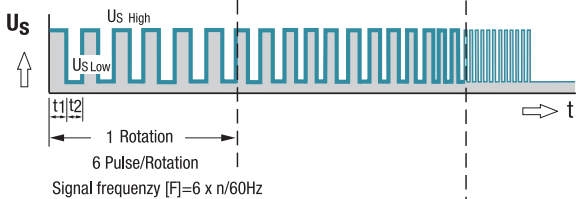

Fan speed

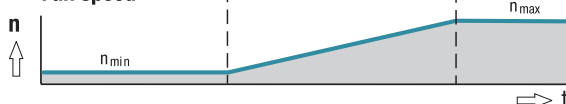

Signal data	Speed signal $U_{S\text{Low}}$	Condition: I_{sink}	Speed signal $U_{S\text{High}}$	Condition: I_{source}	Admissible sink current $I_{\text{sink max}}$	Fan description Basic type
Type	VDC	mA	VDC	mA	mA	Page
614 N/12 GM	≤ 0.4	1	2.5–5.5	1	1	39
618 N/12 N	≤ 0.4	1	2.5–5.5	1	1	39
8412 N/12 H	≤ 0.4	1	2.5–5.5	1	1	44
4412 F/12 GM	≤ 0.4	1	2.5–5.5	1	1	53
4418 F/12	≤ 0.4	1	2.5–5.5	1	1	53
4312 /12 M	≤ 0.4	1	2.5–5.5	1	1	56
4314 /12	≤ 0.4	1	2.5–5.5	1	1	56
4182 N/12 X	≤ 0.4	1	2.5–5.5	1	1	60

Subject to change

Note:

With these fan options, deviations in regard to temperature range, voltage range and power consumption are possible compared with standard fan data.

Available on request:

- Electrically isolated speed signal circuit
- Varying voltage potentials for power and logic circuit

Signal data		Speed signal U _S Low	Condition: I _{sink}	Speed signal U _S High	Condition: I _{source}	Admissible sink current I _{sink} max.	Fan description Basic type
Type	VDC	mA	VDC	mA	mA	Page	
7214 N/12	≤0.4	2	2.5–5.5	1	≤20	70	
6424/12 H	≤0.4	2	2.5–5.5	1	≤20	71	
DV 6424/12	≤0.4	2	4.5–5.25	2	≤12	73	
DV 6448/12	≤0.4	2	4.5–5.25	2	≤12	73	
RG 125-19/12 N/12	≤0.4	1	2.5–5.5	1	≤1	103	
RG 160-28/12 N/12	≤0.4	2	2.5–5.5	1	≤5	104	
RG 160-28/18 N/12	≤0.4	2	2.5–5.5	1	≤20	104	
RER 125-19/12 N/12	≤0.4	1	2.5–5.5	1	≤1	116	
RER 160-28/12 N/12	≤0.4	2	2.5–5.5	1	≤5	118	
RER 160-28/18 N/12	≤0.4	2	2.5–5.5	1	≤20	118	

Subject to change

Note:

Fans that come with these fan specials could have variations with respect to the temperature range, voltage range, and power consumption compared to standard fans without specials.