

Enable High Flux and Cost Efficient System

Z Power Chip on board – ZC series

SDWx7F1C (SDW07F1C, SDW87F1C)

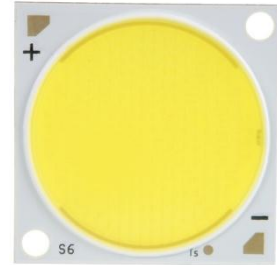

Product Brief

Description

- The ZC series are LED arrays which provide High Flux and High Efficacy.
- It is especially designed for easy assembly of Lighting fixtures by eliminating reflow soldering process.
- It's thermal management is excellent than other power LED solutions with wider Metal area.
- ZC series are ideal light sources for General Lighting applications including Replacement Lamps, Industrial & Commercial Lightings and other high Lumen required applications.

Features and Benefits

- Size 38mm * 38 mm
- High Efficacy typ. 150 lm/W
- Flux range from 2,000~19,000lm
- Power dissipation 15~ 160W
- Maximum current
- 3000K CCT with CRI 80
- Uniformed Shadow
- Excellent Thermal management

Key Applications

- Commercial – Downlight
- Out door area – High/Low Bay lighting, Street lighting, Tunnel lighting
- Architectural
- Industrial – High/Low Bay lighting

Table 1. Product Selection Table

| Part Number | CCT [K] | | | |
|-------------|------------|------|------|------|
| | Color | Min. | Typ. | Max. |
| SDW07F1C | Cool White | 4700 | - | 6000 |
| SDW87F1C | Warm White | 2600 | - | 4200 |

Table of Contents

| Index | |
|---|----|
| • Product Brief | 1 |
| Table of Contents | 2 |
| • Performance Characteristics | 3 |
| • Characteristics Graph | 6 |
| • Color Bin Structure | 12 |
| • Mechanical Dimensions | 17 |
| • Packaging Specification | 18 |
| • Product Nomenclature (Labeling Information) | 20 |
| • Handling of Silicone Resin for LEDs | 21 |
| • Precaution For Use | 22 |
| • Company Information | 25 |

Performance Characteristics

Table 2-1. Electro Optical Characteristics, $T_j=25^{\circ}\text{C}$

| Part Number | CCT (K) ^[1] | Typical Luminous Flux Φ_v ^[3] (lm) | Typical Forward Voltage (V) | CRI ^[5] , R_a | Viewing Angle (degrees) $2\theta_{1/2}$ |
|-------------|------------------------|--|-----------------------------|----------------------------|---|
| | Typ. | 1.5A | 1.5A | Min. | Typ. |
| SDW07F1C | 5000 | 11,800 | 53 | 70 | 124 |
| | 4000 | 11,400 | 53 | 80 | 124 |
| SDW87F1C | 3000 | 11,000 | 53 | 80 | 124 |
| | 2700 | 10,500 | 53 | 80 | 124 |

Table 2-2. Electro Optical Characteristics, $T_j=85^{\circ}\text{C}$

| Part Number | CCT (K) ^[1] | Typical Luminous Flux Φ_v ^[3] (lm) | Typical Forward Voltage (V) | CRI ^[5] , R_a | Viewing Angle (degrees) $2\theta_{1/2}$ |
|-------------|------------------------|--|-----------------------------|----------------------------|---|
| | Typ. | 1.5A | 1.5A | Min. | Typ. |
| SDW07F1C | 5000 | 10,600 | 51.3 | 70 | 124 |
| | 4000 | 10,250 | 51.3 | 80 | 124 |
| SDW87F1C | 3000 | 9,900 | 51.3 | 80 | 124 |
| | 2700 | 9,400 | 51.3 | 80 | 124 |

Notes :

1. Correlated Color Temperature is derived from the CIE 1931 Chromaticity diagram. Color coordinate : ± 0.005 , CCT $\pm 5\%$ tolerance.
2. Seoul Semiconductor maintains a tolerance of $\pm 7\%$ on flux and power measurements.
3. Φ_v is the total luminous flux output as measured with an integrating sphere.
4. Tolerance is $\pm 3\%$ on forward voltage measurements.
5. Tolerance is ± 2 on CRI measurements.

* No values are provided by real measurement. Only for reference purpose.

Performance Characteristics

Table 2-3. Electro Optical Characteristics, $T_j=25^{\circ}\text{C}$

| Part Number | CCT (K) ^[1] | Typical Luminous Flux Φ_v ^[3] (lm) | Typical Forward Voltage (V) | CRI ^[5] , R_a | Viewing Angle (degrees) $2\theta_{1/2}$ |
|-------------|------------------------|--|-----------------------------|----------------------------|---|
| | Typ. | 1.8A | 1.8A | Min. | Typ. |
| SDW07F1C | 5000 | 13,750 | 53.6 | 70 | 124 |
| | 4000 | 13,300 | 53.6 | 80 | 124 |
| SDW87F1C | 3000 | 12,750 | 53.6 | 80 | 124 |
| | 2700 | 12,200 | 53.6 | 80 | 124 |

Table 2-4. Electro Optical Characteristics, $T_j=85^{\circ}\text{C}$

| Part Number | CCT (K) ^[1] | Typical Luminous Flux Φ_v ^[3] (lm) | Typical Forward Voltage (V) | CRI ^[5] , R_a | Viewing Angle (degrees) $2\theta_{1/2}$ |
|-------------|------------------------|--|-----------------------------|----------------------------|---|
| | Typ. | 1.8A | 1.8A | Min. | Typ. |
| SDW07F1C | 5000 | 12,370 | 51.9 | 70 | 124 |
| | 4000 | 11,970 | 51.9 | 80 | 124 |
| SDW87F1C | 3000 | 11,475 | 51.9 | 80 | 124 |
| | 2700 | 11,000 | 51.9 | 80 | 124 |

Notes :

1. Correlated Color Temperature is derived from the CIE 1931 Chromaticity diagram. Color coordinate : ± 0.005 , CCT $\pm 5\%$ tolerance.
2. Seoul Semiconductor maintains a tolerance of $\pm 7\%$ on flux and power measurements.
3. Φ_v is the total luminous flux output as measured with an integrating sphere.
4. Tolerance is $\pm 3\%$ on forward voltage measurements.
5. Tolerance is ± 2 on CRI measurements.

* No values are provided by real measurement. Only for reference purpose.

Performance Characteristics

Table 3. Absolute Maximum Characteristics, $T_j=25^{\circ}\text{C}$

| Parameter | Symbol | Value | | | Unit |
|-------------------------------------|---------------|-------|------|---------|--------------------|
| | | Min. | Typ. | Max. | |
| Forward Current | I_F | - | 1.5 | 3.0 | A |
| Power Dissipation | P_d | - | 80 | 170 | W |
| Junction Temperature ^[1] | T_j | - | - | 125 | $^{\circ}\text{C}$ |
| Operating Temperature | T_{opr} | -40 | - | 85 | $^{\circ}\text{C}$ |
| Surface Temperature | T_s | - | - | 100 | $^{\circ}\text{C}$ |
| Storage Temperature | T_{stg} | -40 | - | 100 | $^{\circ}\text{C}$ |
| Thermal resistance (J to S) | $R_{th_{JS}}$ | - | 0.2 | - | K/W |
| ESD Sensitivity(HBM) ^[2] | - | - | - | ± 8 | kV |

Notes :

1. $I_F \leq 3\text{A}$
 2. A zener diode is included to protect the product from ESD.
 3. Thermal resistance : $R_{th_{JS}}$ (Junction / solder)
- LED's properties might be different from suggested values like above and below tables if operation condition will be exceeded our parameter range. Care is to be taken that power *dissipation does not* exceed the absolute maximum rating of the product.
 - Thermal resistance can be increased substantially depending on the heat sink design/operating condition, and the maximum possible driving current will decrease accordingly.
 - All measurements were made under the standardized environment of Seoul Semiconductor.

Characteristics Graph

Fig 1. Color Spectrum, $T_j=25^{\circ}\text{C}$, $I_F=1.5\text{A}$

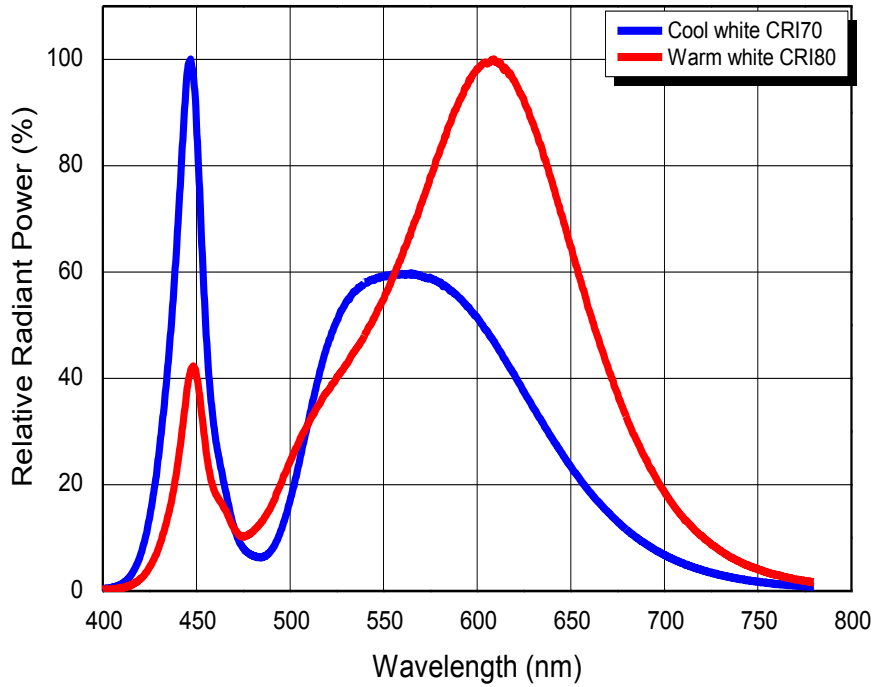

Characteristics Graph

Fig 2. Radiant pattern, $T_j=25^\circ\text{C}$, $I_F=1.5\text{A}$

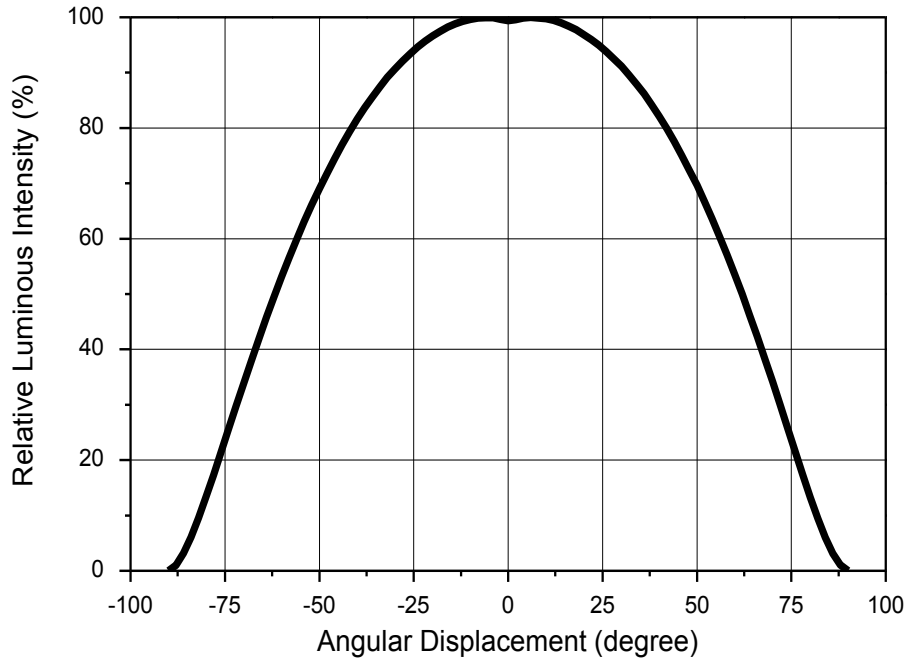

Characteristics Graph

Fig 3. Forward Voltage vs. Forward Current, $T_j=25^\circ\text{C}$

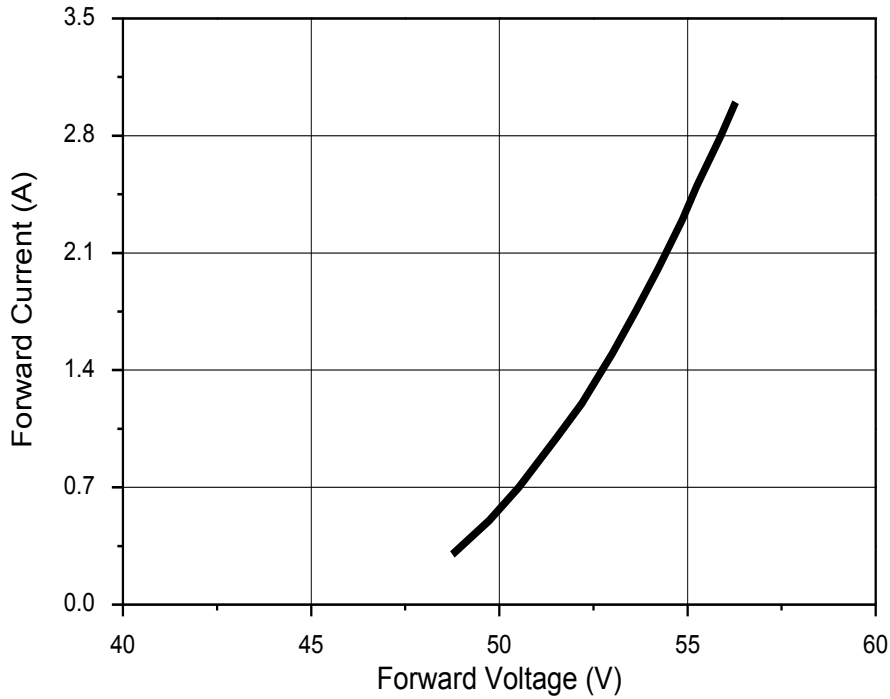
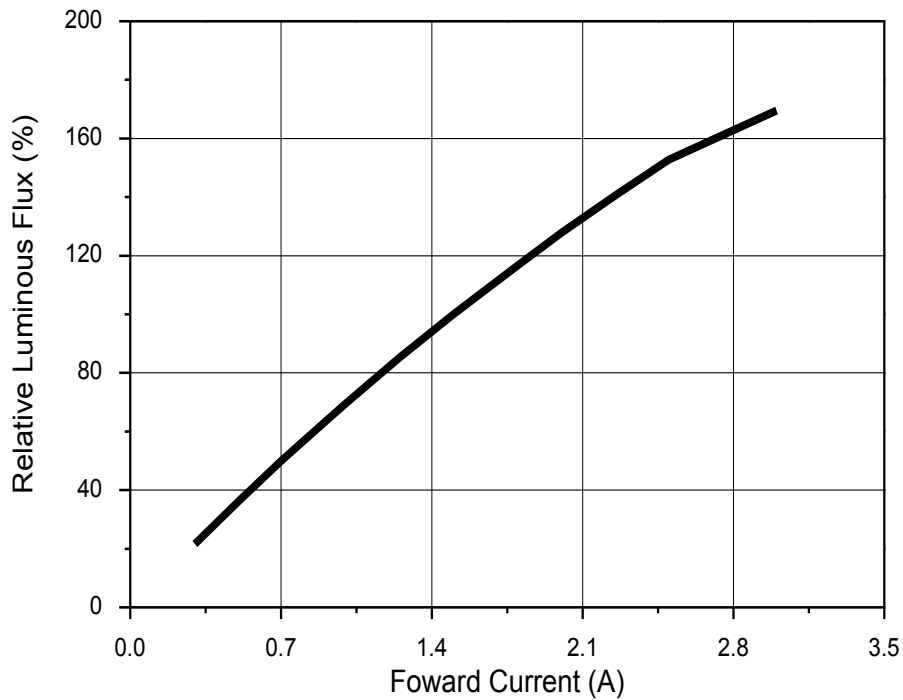
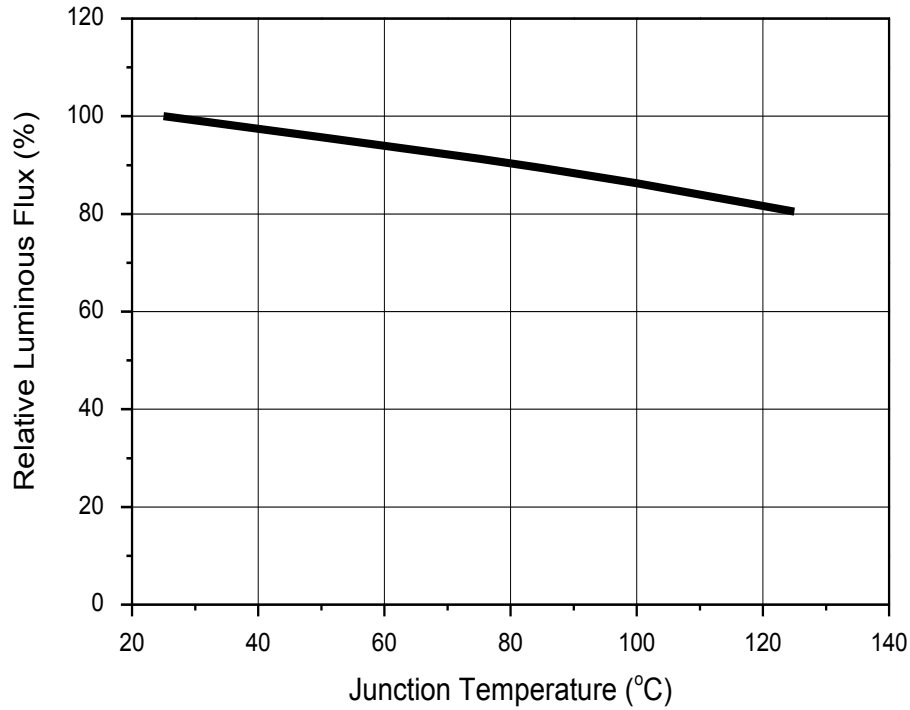
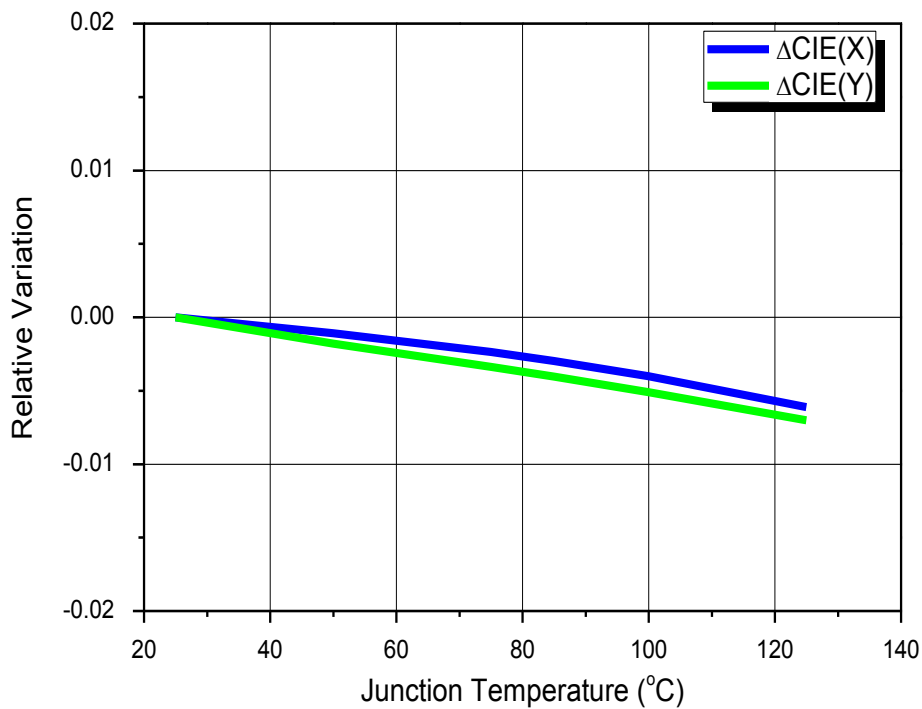

Fig 4. Forward Current vs. Relative Luminous Flux, $T_j=25^\circ\text{C}$



Characteristics Graph

Fig 5. Relative Light Output vs. Junction Temperature, $I_F=1.5A$

Fig 16. Junction Temperature vs. CIE X, Y Shift, $I_F=1.5A$ (Warm white)

Characteristics Graph

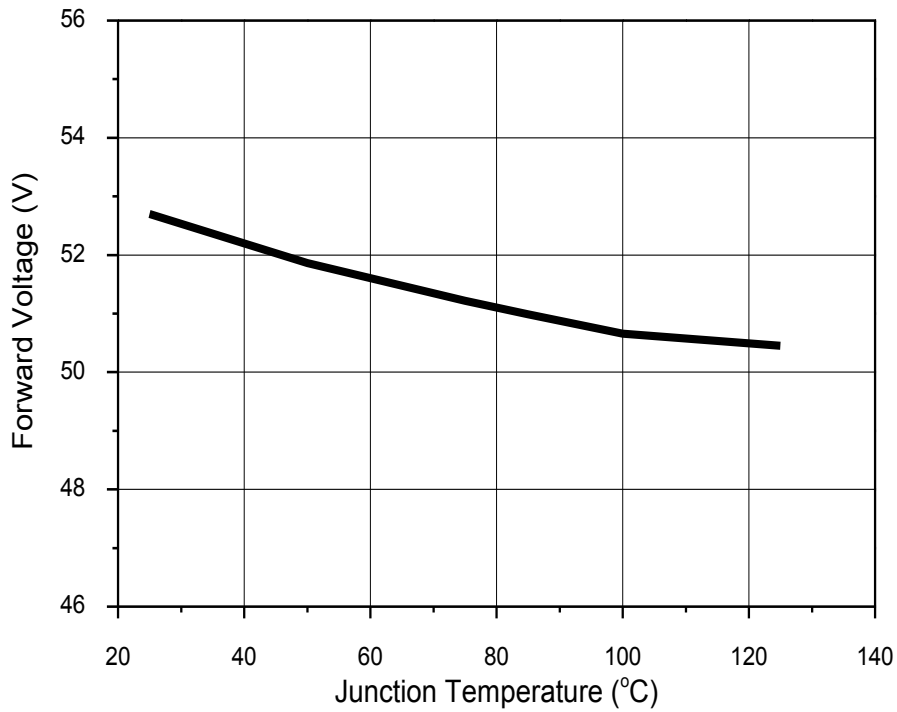
Fig 7. Forward Voltage vs. Junction Temperature, $I_F=1.5A$



Characteristics Graph

Fig 8. Maximum Forward Current vs. Ambient Temperature, $T_j(\text{max.})=125^\circ\text{C}$, $I_F=3\text{A}$

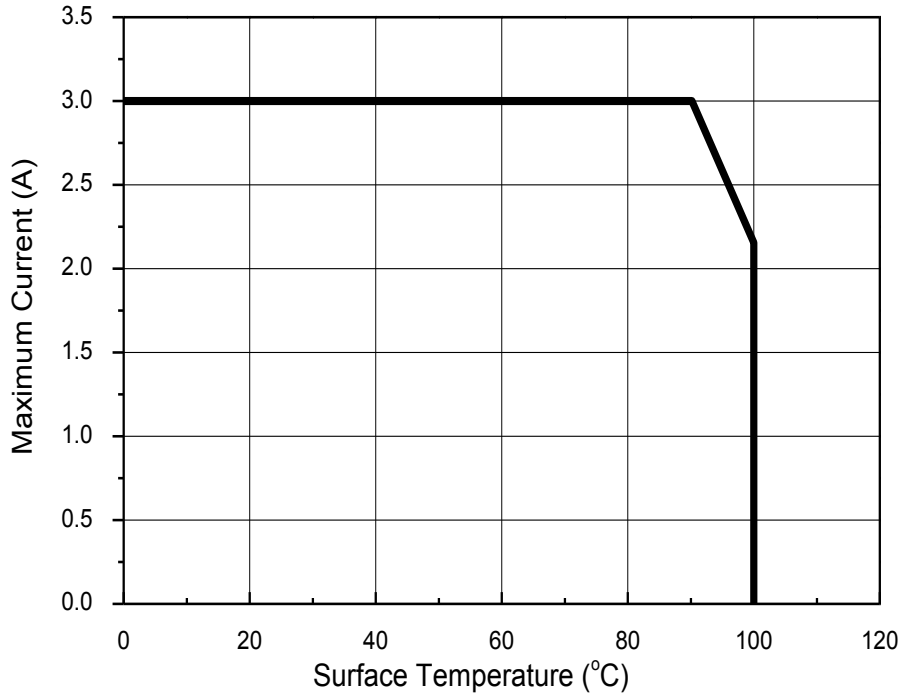

Color Bin Structure

Table 6. Bin Code description

| Part Number | Luminous Flux (lm) @ I _F =1.5A | | | Color Chromaticity Coordinate @ I _F =1.5A | Typical Forward Voltage (V) @ I _F =1.5A | | |
|-------------|--|-------|-------|---|---|------|------|
| | Bin Code | Min. | Max. | | Bin Code | Min. | Max. |
| SDW07F1C | N3 | 11000 | 12300 | Refer to page. 13 ~ 16 | J | 51.5 | 55.5 |
| | O1 | 12300 | 13600 | | | | |
| SDW87F1C | N1 | 8800 | 9800 | | | | |
| | N2 | 9800 | 11000 | | | | |
| | N3 | 11000 | 12300 | | | | |
| | O1 | 12300 | 13600 | | | | |

| Part Number | CCT | CIE | LF rank | | | | VF rank |
|-------------|------------|-----|---------|----|----|----|---------|
| | | | N1 | N2 | N3 | O1 | |
| SDW07F1C | 5300~6000K | B | N1 | N2 | N3 | O1 | J |
| | 4700~5300K | C | N1 | N2 | N3 | O1 | J |
| | 4200~4700K | D | N1 | N2 | N3 | O1 | J |
| | 3700~4200K | E | N1 | N2 | N3 | O1 | J |
| SDW87F1C | 5300~6000K | B | N1 | N2 | N3 | O1 | J |
| | 4700~5300K | C | N1 | N2 | N3 | O1 | J |
| | 4200~4700K | D | N1 | N2 | N3 | O1 | J |
| | 3700~4200K | E | N1 | N2 | N3 | O1 | J |
| | 3200~3700K | F | N1 | N2 | N3 | O1 | J |
| | 2900~3200K | G | N1 | N2 | N3 | O1 | J |
| | 2600~2900K | H | N1 | N2 | N3 | O1 | J |

Notes :

- Star shape [*] means not available now.

Color Bin Structure

CIE Chromaticity Diagram

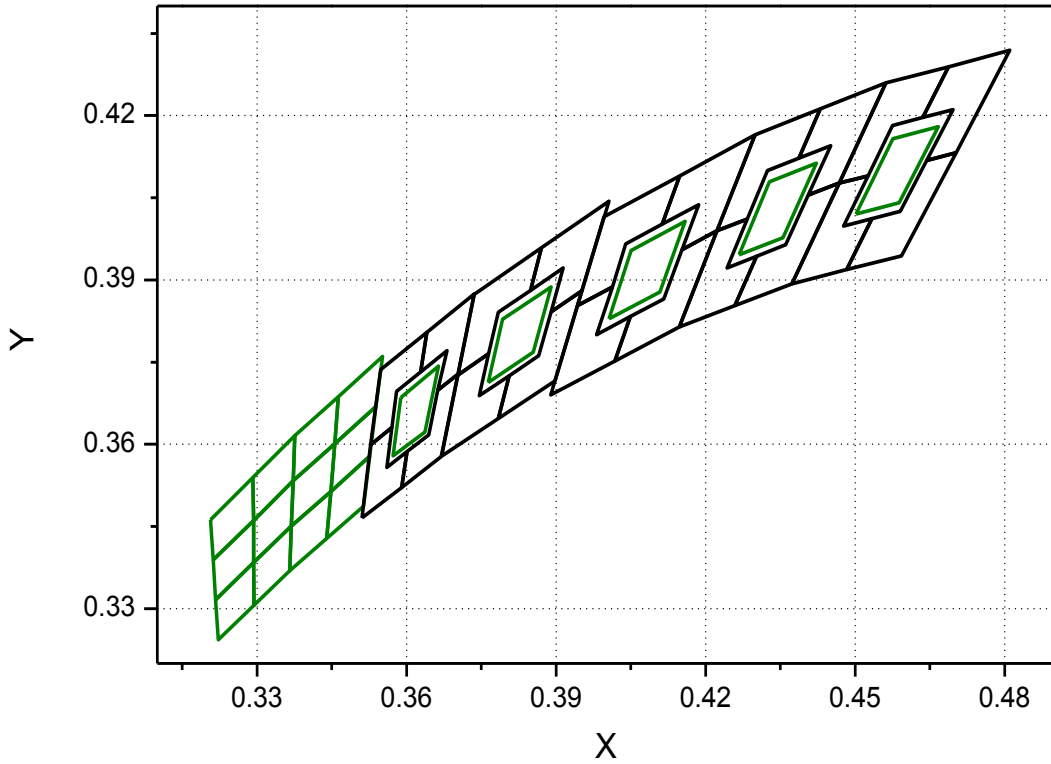

Color Bin Structure

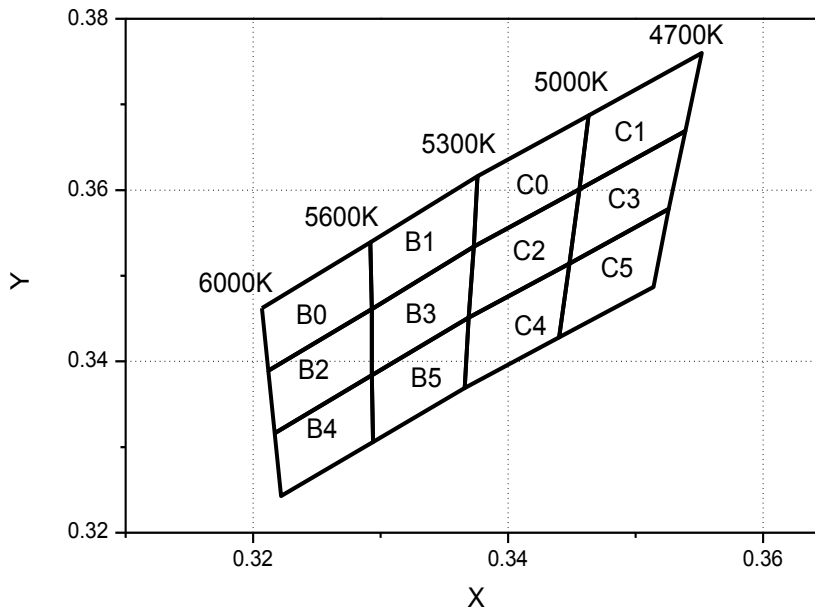
CIE Chromaticity Diagram, $T_j=25^\circ\text{C}$, $I_f=1.5\text{A}$

| B0 | | B1 | | B2 | |
|--------|--------|--------|--------|--------|--------|
| CIE x | CIE y | CIE x | CIE y | CIE x | CIE y |
| 0.3207 | 0.3462 | 0.3292 | 0.3539 | 0.3212 | 0.3389 |
| 0.3212 | 0.3389 | 0.3293 | 0.3461 | 0.3217 | 0.3316 |
| 0.3293 | 0.3461 | 0.3373 | 0.3534 | 0.3293 | 0.3384 |
| 0.3292 | 0.3539 | 0.3376 | 0.3616 | 0.3293 | 0.3461 |
| B3 | | B4 | | B5 | |
| CIE x | CIE y | CIE x | CIE y | CIE x | CIE y |
| 0.3293 | 0.3461 | 0.3217 | 0.3316 | 0.3293 | 0.3384 |
| 0.3293 | 0.3384 | 0.3222 | 0.3243 | 0.3294 | 0.3306 |
| 0.3369 | 0.3451 | 0.3294 | 0.3306 | 0.3366 | 0.3369 |
| 0.3373 | 0.3534 | 0.3293 | 0.3384 | 0.3369 | 0.3451 |
| C0 | | C1 | | C2 | |
| CIE x | CIE y | CIE x | CIE y | CIE x | CIE y |
| 0.3376 | 0.3616 | 0.3463 | 0.3687 | 0.3373 | 0.3534 |
| 0.3373 | 0.3534 | 0.3456 | 0.3601 | 0.3369 | 0.3451 |
| 0.3456 | 0.3601 | 0.3539 | 0.3669 | 0.3448 | 0.3514 |
| 0.3463 | 0.3687 | 0.3552 | 0.3760 | 0.3456 | 0.3601 |
| C3 | | C4 | | C5 | |
| CIE x | CIE y | CIE x | CIE y | CIE x | CIE y |
| 0.3456 | 0.3601 | 0.3369 | 0.3451 | 0.3448 | 0.3514 |
| 0.3448 | 0.3514 | 0.3366 | 0.3369 | 0.3440 | 0.3428 |
| 0.3526 | 0.3578 | 0.3440 | 0.3428 | 0.3514 | 0.3487 |
| 0.3539 | 0.3669 | 0.3448 | 0.3514 | 0.3526 | 0.3578 |

Color Bin Structure

CIE Chromaticity Diagram, $T_j=25^\circ\text{C}$, $I_f=1.5\text{A}$

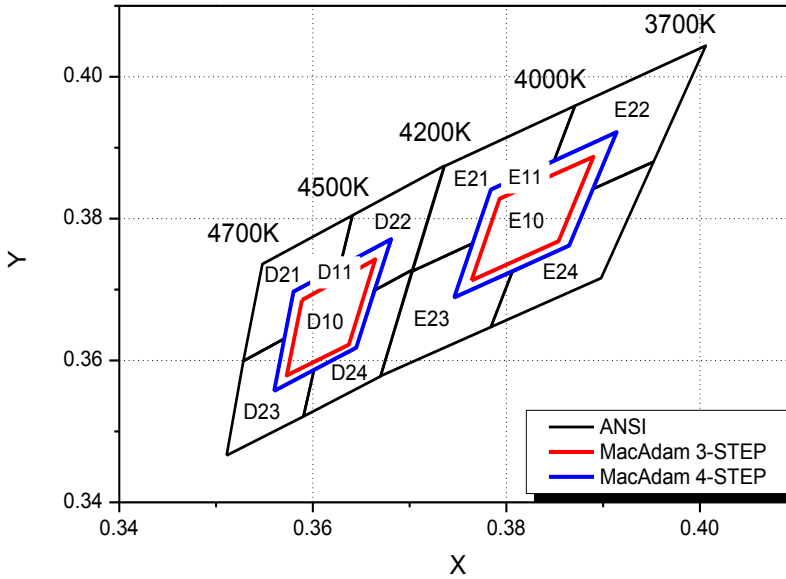

| 3-STEP | | | | 4-STEP | | | |
|--------|--------|--------|--------|--------|--------|--------|--------|
| D10 | | E10 | | D11 | | E11 | |
| CIE x | CIE y | CIE x | CIE y | CIE x | CIE y | CIE x | CIE y |
| 0.3589 | 0.3685 | 0.3764 | 0.3713 | 0.3560 | 0.3557 | 0.3746 | 0.3689 |
| 0.3665 | 0.3742 | 0.3793 | 0.3828 | 0.3580 | 0.3697 | 0.3784 | 0.3841 |
| 0.3637 | 0.3622 | 0.3890 | 0.3887 | 0.3681 | 0.3771 | 0.3914 | 0.3922 |
| 0.3573 | 0.3579 | 0.3854 | 0.3768 | 0.3645 | 0.3618 | 0.3865 | 0.3762 |

| ANSI | | | | | | | |
|--------|--------|--------|--------|--------|--------|--------|--------|
| D21 | | D22 | | D23 | | D24 | |
| CIE x | CIE y | CIE x | CIE y | CIE x | CIE y | CIE x | CIE y |
| 0.3528 | 0.3599 | 0.3628 | 0.3732 | 0.3601 | 0.3587 | 0.3511 | 0.3466 |
| 0.3548 | 0.3736 | 0.3641 | 0.3805 | 0.3645 | 0.3618 | 0.3528 | 0.3599 |
| 0.3641 | 0.3805 | 0.3736 | 0.3874 | 0.3663 | 0.3699 | 0.3570 | 0.3631 |
| 0.3628 | 0.3732 | 0.3703 | 0.3728 | 0.3703 | 0.3728 | 0.3560 | 0.3558 |
| 0.3580 | 0.3697 | 0.3663 | 0.3699 | 0.3670 | 0.3578 | 0.3601 | 0.3587 |
| 0.3570 | 0.3631 | 0.3681 | 0.3771 | 0.3590 | 0.3521 | 0.3590 | 0.3521 |
| E21 | | E22 | | E23 | | E24 | |
| CIE x | CIE y | CIE x | CIE y | CIE x | CIE y | CIE x | CIE y |
| 0.3703 | 0.3726 | 0.3890 | 0.3842 | 0.3670 | 0.3578 | 0.3784 | 0.3647 |
| 0.3736 | 0.3874 | 0.3914 | 0.3922 | 0.3703 | 0.3726 | 0.3806 | 0.3725 |
| 0.3871 | 0.3959 | 0.3849 | 0.3881 | 0.3765 | 0.3765 | 0.3865 | 0.3762 |
| 0.3849 | 0.3881 | 0.3871 | 0.3959 | 0.3746 | 0.3689 | 0.3890 | 0.3842 |
| 0.3784 | 0.3841 | 0.4006 | 0.4044 | 0.3806 | 0.3725 | 0.3952 | 0.3880 |
| 0.3765 | 0.3765 | 0.3952 | 0.3880 | 0.3784 | 0.3647 | 0.3898 | 0.3716 |

Color Bin Structure

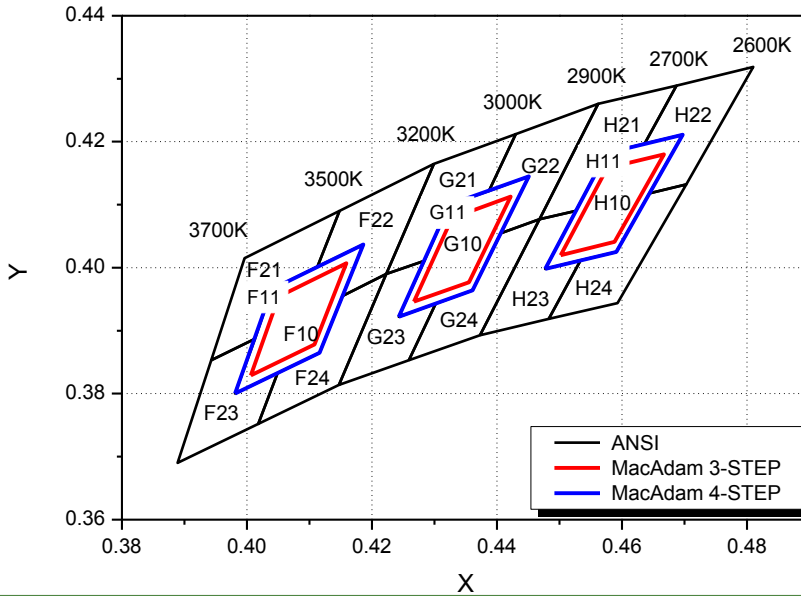
CIE Chromaticity Diagram, $T_j=25^\circ\text{C}$, $I_f=1.5\text{A}$

| 3-STEP | | | | | | 4-STEP | | | | | |
|--------|--------|--------|--------|--------|--------|--------|--------|--------|--------|--------|--------|
| F10 | | G10 | | H10 | | F11 | | G11 | | H11 | |
| CIE x | CIE y | CIE x | CIE y | CIE x | CIE y | CIE x | CIE y | CIE x | CIE y | CIE x | CIE y |
| 0.4006 | 0.3829 | 0.4267 | 0.3946 | 0.4502 | 0.4020 | 0.3981 | 0.3800 | 0.4243 | 0.3922 | 0.4477 | 0.3998 |
| 0.4051 | 0.3954 | 0.4328 | 0.4079 | 0.4576 | 0.4158 | 0.4040 | 0.3966 | 0.4324 | 0.4100 | 0.4575 | 0.4182 |
| 0.4159 | 0.4007 | 0.4422 | 0.4113 | 0.4667 | 0.4180 | 0.4186 | 0.4037 | 0.4451 | 0.4145 | 0.4697 | 0.4211 |
| 0.4108 | 0.3878 | 0.4355 | 0.3977 | 0.4588 | 0.4041 | 0.4116 | 0.3865 | 0.4361 | 0.3964 | 0.4591 | 0.4025 |
| ANSI | | | | | | | | | | | |
| F21 | | F22 | | F23 | | F24 | | | | | |
| CIE x | CIE y | CIE x | CIE y | CIE x | CIE y | CIE x | CIE y | | | | |
| 0.4148 | 0.4090 | 0.4013 | 0.3887 | 0.4223 | 0.3990 | 0.4299 | 0.4165 | | | | |
| 0.3996 | 0.4015 | 0.3943 | 0.3853 | 0.4153 | 0.3955 | 0.4148 | 0.4090 | | | | |
| 0.3943 | 0.3853 | 0.3889 | 0.3690 | 0.4116 | 0.3865 | 0.4113 | 0.4002 | | | | |
| 0.4013 | 0.3887 | 0.4018 | 0.3752 | 0.4049 | 0.3833 | 0.4186 | 0.4037 | | | | |
| 0.4040 | 0.3966 | 0.4049 | 0.3833 | 0.4018 | 0.3752 | 0.4153 | 0.3955 | | | | |
| 0.4113 | 0.4002 | 0.3981 | 0.3800 | 0.4147 | 0.3814 | 0.4223 | 0.3990 | | | | |
| G21 | | G22 | | G23 | | G24 | | | | | |
| CIE x | CIE y | CIE x | CIE y | CIE x | CIE y | CIE x | CIE y | | | | |
| 0.4223 | 0.3990 | 0.4406 | 0.4055 | 0.4147 | 0.3814 | 0.4259 | 0.3853 | | | | |
| 0.4299 | 0.4165 | 0.4451 | 0.4145 | 0.4223 | 0.3990 | 0.4302 | 0.3943 | | | | |
| 0.4430 | 0.4212 | 0.4387 | 0.4122 | 0.4284 | 0.4011 | 0.4361 | 0.3964 | | | | |
| 0.4387 | 0.4122 | 0.4430 | 0.4212 | 0.4243 | 0.3922 | 0.4406 | 0.4055 | | | | |
| 0.4324 | 0.4100 | 0.4562 | 0.4260 | 0.4302 | 0.3943 | 0.4468 | 0.4077 | | | | |
| 0.4284 | 0.4011 | 0.4468 | 0.4077 | 0.4259 | 0.3853 | 0.4373 | 0.3893 | | | | |
| H21 | | H22 | | H23 | | H24 | | | | | |
| CIE x | CIE y | CIE x | CIE y | CIE x | CIE y | CIE x | CIE y | | | | |
| 0.4468 | 0.4077 | 0.4644 | 0.4118 | 0.4373 | 0.3893 | 0.4483 | 0.3919 | | | | |
| 0.4562 | 0.4260 | 0.4697 | 0.4211 | 0.4468 | 0.4077 | 0.4534 | 0.4012 | | | | |
| 0.4687 | 0.4289 | 0.4636 | 0.4197 | 0.4526 | 0.4090 | 0.4591 | 0.4025 | | | | |
| 0.4636 | 0.4197 | 0.4687 | 0.4289 | 0.4477 | 0.3998 | 0.4644 | 0.4118 | | | | |
| 0.4575 | 0.4182 | 0.4810 | 0.4319 | 0.4534 | 0.4012 | 0.4703 | 0.4132 | | | | |
| 0.4526 | 0.4090 | 0.4703 | 0.4132 | 0.4483 | 0.3919 | 0.4593 | 0.3944 | | | | |

Mechanical Dimensions

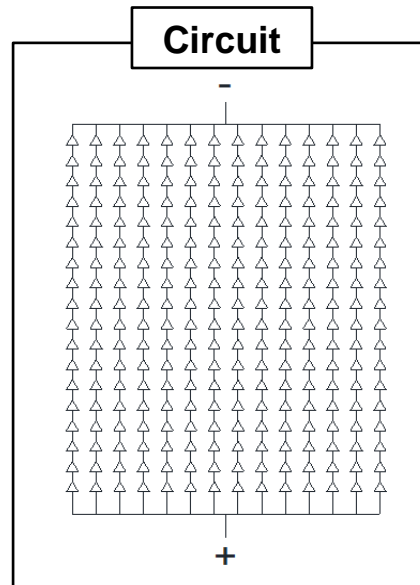
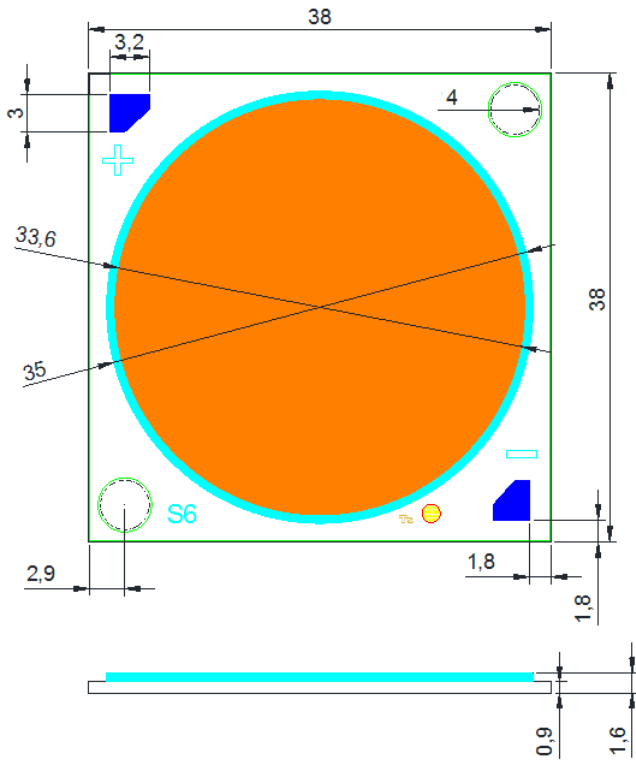

Notes :

1. All dimensions are in millimeters.
2. Scale : none
3. Undefined tolerance is $\pm 0.3\text{mm}$

Packaging Specification

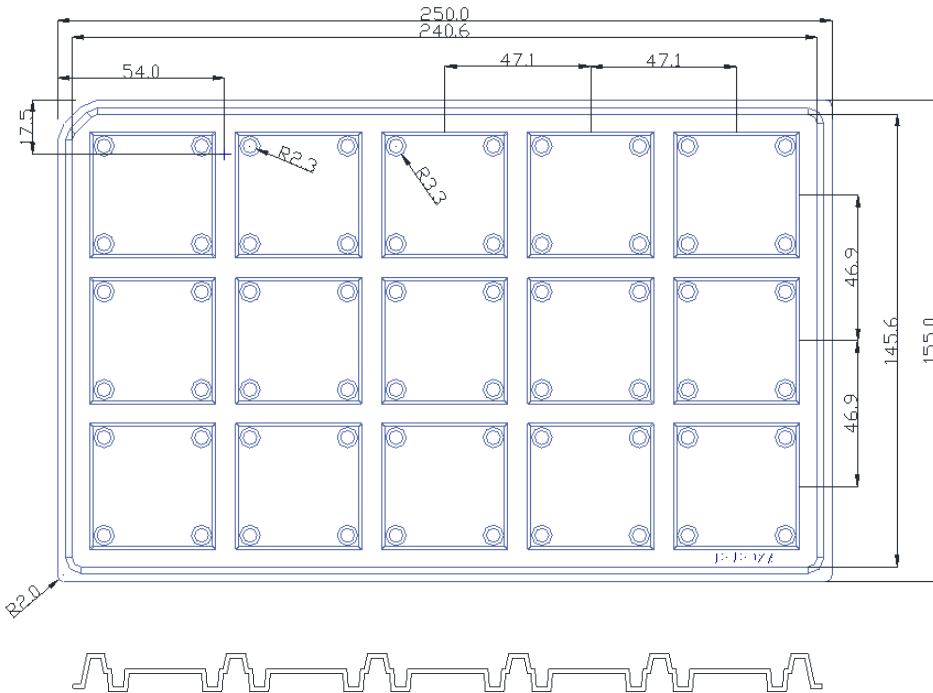

Notes :

1. Quantity : 15pcs/Tray
2. All dimensions are in millimeters (tolerance : ± 0.3)
3. Scale none

Packaging Specification

Aluminum Bag

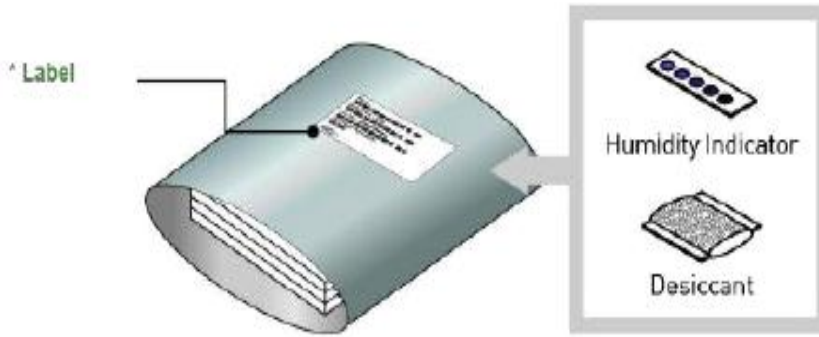

Outer Box

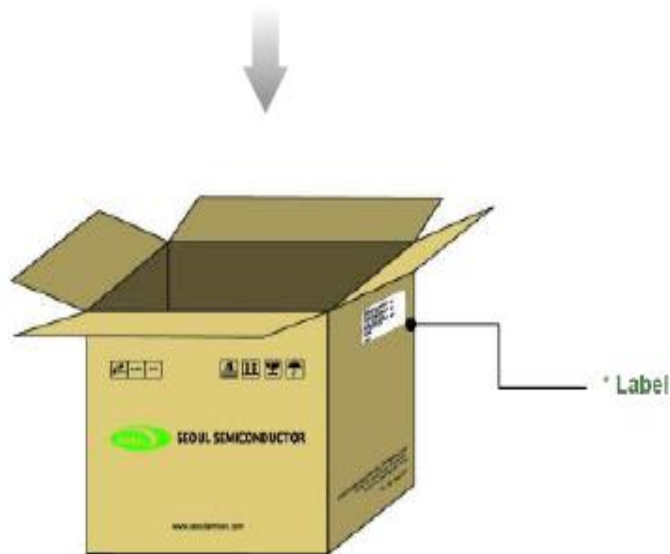

Notes :

- (1) Heat Sealed after packing (Use Zipper Bag)
- (2) Quantity : min 8Tray(120pcs) ~ max 20Tray(300pcs) /Bag

Product Nomenclature

Table 4. Part Numbering System : X₁X₂X₃ X₄X₅ X₆X₇ X₈

| Part Number Code | Description | Part Number | Value |
|-------------------------------|---------------------|-------------|--------------|
| X ₁ | Company | S | |
| X ₂ | Package series | D | |
| X ₃ X ₄ | Color Specification | W0 | CRI 70 |
| | | W8 | CRI 80 |
| X ₅ | Series number | 7 | |
| X ₆ | Lens type | F | Flat |
| X ₇ | PCB type | 1 | PCB |
| X ₈ | Revision number | C | New COB type |

Table 5. Lot Numbering System : Y₁Y₂Y₃Y₄Y₅Y₆ – Y₇Y₈Y₉Y₁₀ – Y₁₁Y₁₂Y₁₃

| Lot Number Code | Description | Lot Number | Value |
|--|-------------|------------|-------|
| Y ₁ Y ₂ | Year | | |
| Y ₃ Y ₄ | Month | | |
| Y ₅ Y ₆ | Day | | |
| Y ₇ Y ₈ Y ₉ Y ₁₀ | Mass order | | |
| Y ₁₁ Y ₁₂ Y ₁₃ | Tray No. | | |

Handling of Silicone Resin for LEDs

- (1) During processing, mechanical stress on the surface should be minimized as much as possible. Sharp objects of all types should not be used to pierce the sealing compound.



- (2) In general, LEDs should only be handled from the side. By the way, this also applies to LEDs without a silicone sealant, since the surface can also become scratched.

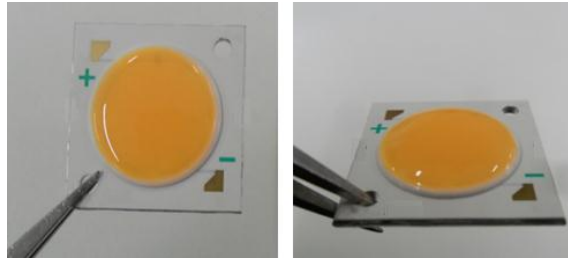

- (3) Silicone differs from materials conventionally used for the manufacturing of LEDs. These conditions must be considered during the handling of such devices. Compared to standard encapsulants, silicone is generally softer, and the surface is more likely to attract dust. As mentioned previously, the increased sensitivity to dust requires special care during processing. In cases where a minimal level of dirt and dust particles cannot be guaranteed, a suitable cleaning solution must be applied to the surface after the soldering of wire.
- (4) Seoul Semiconductor suggests using isopropyl alcohol for cleaning. In case other solvents are used, it must be assured that these solvents do not dissolve the package or resin. Ultrasonic cleaning is not recommended. Ultrasonic cleaning may cause damage to the LED.
- (5) Please do not mold this product into another resin (epoxy, urethane, etc) and do not handle this product with acid or sulfur material in sealed space.
- (6) Avoid leaving fingerprints on silicone resin parts.

Precaution for Use

(1) Storage

To avoid the moisture penetration, we recommend storing Power LEDs in a dry box with a desiccant.

(2) For manual soldering

Seoul Semiconductor recommends the soldering condition

(ZC series product is not adaptable to reflow process)

a. Use lead-free soldering

b. Soldering should be implemented using a soldering equipment at temperature lower than 350°C.

c. Before proceeding the next step, product temperature must be stabilized at room temperature.

(3) Components should not be mounted on warped (non coplanar) portion of PCB.

(4) Radioactive exposure is not considered for the products listed here in.

(5) It is dangerous to drink the liquid or inhale the gas generated by such products when chemically disposed of.

(6) This device should not be used in any type of fluid such as water, oil, organic solvent and etc.
When washing is required, IPA (Isopropyl Alcohol) should be used.

(7) When the LEDs are in operation the maximum current should be decided after measuring the package temperature.

(8) The appearance and specifications of the product may be modified for improvement without notice.

(9) Long time exposure of sun light or occasional UV exposure will cause silicone discoloration.

(10) Attaching LEDs, do not use adhesive that outgas organic vapor.

(11) The driving circuit must be designed to allow forward voltage only when it is ON or OFF. If the reverse voltage is applied to LED, migration can be generated resulting in LED damage.

(12) Please do not touch any of the circuit board, components or terminals with bare hands or metal while circuit is electrically active.

Precaution for Use

(13) VOCs (Volatile organic compounds) emitted from materials used in the construction of fixtures can penetrate silicone encapsulants of LEDs and discolor when exposed to heat and photonic energy. The result can be a significant loss of light output from the fixture. Knowledge of the properties of the materials selected to be used in the construction of fixtures can help prevent these issues.

(14) LEDs are sensitive to Electro-Static Discharge (ESD) and Electrical Over Stress (EOS). Below is a list of suggestions that Seoul Semiconductor purposes to minimize these effects.

I . ESD (Electro Static Discharge)

Electrostatic discharge (ESD) is defined as the release of static electricity when two objects come into contact. While most ESD events are considered harmless, it can be an expensive problem in many industrial environments during production and storage. The damage from ESD to LEDs may cause the product to demonstrate unusual characteristics such as:

- Increase in reverse leakage current lowered turn-on voltage
- Abnormal emissions from the LED at low current

The following recommendations are suggested to help minimize the potential for an ESD event. One or more recommended work area suggestions:

- Ionizing fan setup
- ESD table/shelf mat made of conductive materials
- ESD safe storage containers

One or more personnel suggestion options:

- Antistatic wrist-strap
- Antistatic material shoes
- Antistatic clothes

Environmental controls:

- Humidity control (ESD gets worse in a dry environment)

Precaution for Use

b. EOS (Electrical Over Stress)

Electrical Over-Stress (EOS) is defined as damage that may occur when an electronic device is subjected to a current or voltage that is beyond the maximum specification limits of the device. The effects from an EOS event can be noticed through product performance like:

- Changes to the performance of the LED package
(If the damage is around the bond pad area and since the package is completely encapsulated the package may turn on but flicker show severe performance degradation.)
- Changes to the light output of the luminaire from component failure
- Components on the board not operating at determined drive power

Failure of performance from entire fixture due to changes in circuit voltage and current across total circuit causing trickle down failures. It is impossible to predict the failure mode of every LED exposed to electrical overstress as the failure modes have been investigated to vary, but there are some common signs that will indicate an EOS event has occurred:

- Damaged may be noticed to the bond wires (appearing similar to a blown fuse)
- Damage to the bond pads located on the emission surface of the LED package
(shadowing can be noticed around the bond pads while viewing through a microscope)
- Anomalies noticed in the encapsulation and phosphor around the bond wires.
- This damage usually appears due to the thermal stress produced during the EOS event.

c. To help minimize the damage from an EOS event Seoul Semiconductor recommends utilizing:

- A surge protection circuit
- An appropriately rated over voltage protection device
- A current limiting device



Company Information

Published by

Seoul Semiconductor © 2013 All Rights Reserved.

Company Information

Seoul Semiconductor (SeoulSemicon.com) manufactures and packages a wide selection of light emitting diodes (LEDs) for the automotive, general illumination/lighting, appliance, signage and back lighting markets. The company is the world's fifth largest LED supplier, holding more than 10,000 patents globally, while offering a wide range of LED technology and production capacity in areas such as "nPola", deep UV LEDs, "Acrich", the world's first commercially produced AC LED, and "Acrich MJT - Multi-Junction Technology" a proprietary family of high-voltage LEDs. The company's broad product portfolio includes a wide array of package and device choices such as Acrich, high-brightness LEDs, mid-power LEDs, side-view LEDs, through-hole type LED lamps, custom displays, and sensors. The company is vertically integrated from epitaxial growth and chip manufacture in its fully owned subsidiary, Seoul Viosys, through packaged LEDs and LED modules in three Seoul Semiconductor manufacturing facilities. Seoul Viosys also manufactures a wide range of unique deep-UV wavelength devices.

Legal Disclaimer

Information in this document is provided in connection with Seoul Semiconductor products. With respect to any examples or hints given herein, any typical values stated herein and/or any information regarding the application of the device, Seoul Semiconductor hereby disclaims any and all warranties and liabilities of any kind, including without limitation, warranties of non-infringement of intellectual property rights of any third party. The appearance and specifications of the product can be changed to improve the quality and/or performance without notice.