

Axial Auto Surge Suppressor

Stand-off Voltage - 18 to 43 Volts

12000 Watt Peak Pulse Power

Features

- Glass passivated junction
- Plastic package P-600
- Meet AEC-Q101 requirement
- Bi-directional or Un-directional
- Very Low Clamping Voltage
- High temperature soldering guaranteed: 265°C/10 seconds/.375", (9.5mm) lead length, 5lbs., (2.3kg) tension
- Continued current transient suppressor
- RoHS compliant
- 12KW peak pulse power capability on 10/1000us waveform



IEC Compatibility

- ISO 16750-2 Test A 12V System (87V 0.5Ω 400ms 10c)
24V System (200V 4Ω 350ms 10c)

Applications

- Auto powers system
- Can-bus
- ABS powers
- Car audio and video
- Automotive instrument
- Bluetooth
- Car GPS

I-V Curve Characteristics

Uni-directional

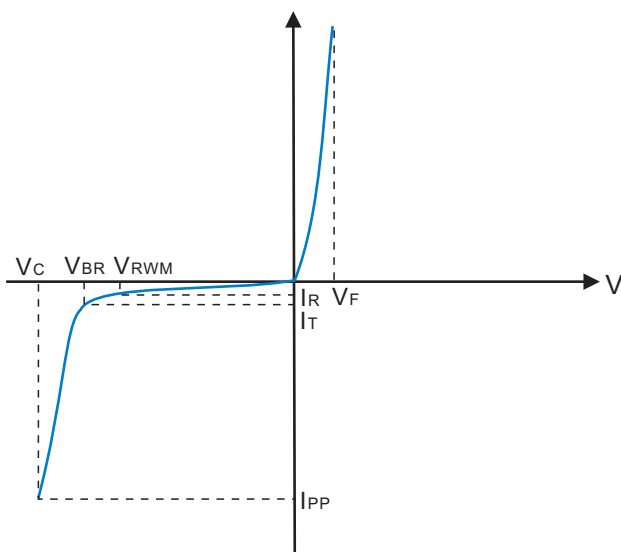

Bi-directional

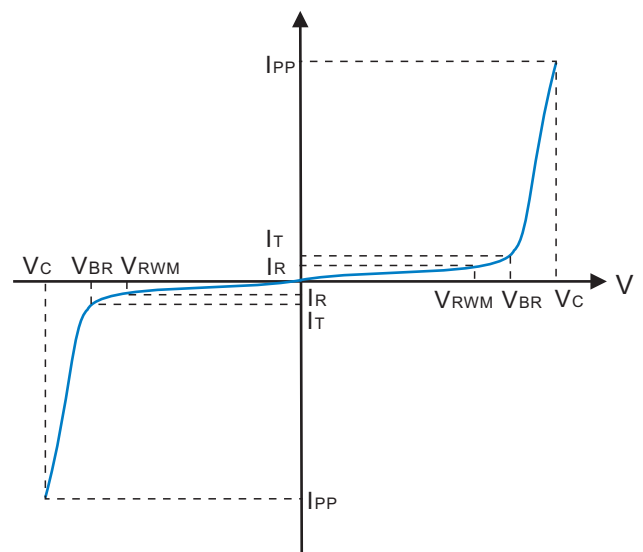

Dimensions (P600)

Case Style P600

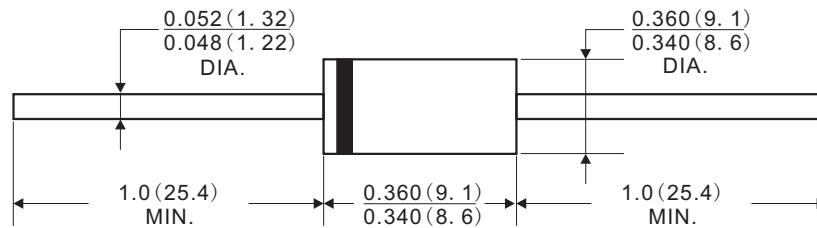

Dimensions in inches and (millimeters)

Electrical Characteristics

***Stand for commonly used models

PKS Part Number		Stand-Off Voltage	Reverse Leakage @ V_{RWM}	Breakdown Voltage @ I_T		Test Current	Max. Clamping Voltage @ I_{pp} 10/1000 μ s	
UNI-Polar	BI-Polar	$V_{RWM}(V)$	$I_R(\mu A)$	$V_{BR}(V)Min.$	$V_{BR}(V)Max.$	$I_T(mA)$	$V_c(V)$	$I_{pp}(A)$
PKS18A	PKS18CA	18	10	20.0	22.1	5	29.2	411.0
PKS20A	PKS20CA	20	10	22.2	24.5	5	32.4	370.4
* PKS22A	PKS22CA	22	2	24.0	26.9	5	35.5	338.0
PKS24A	PKS24CA	24	2	26.7	29.5	5	38.9	308.5
PKS26A	PKS26CA	26	2	28.9	31.9	5	42.1	285.0
PKS30A	PKS30CA	30	2	33.3	36.8	5	48.4	247.9
PKS33A	PKS33CA	33	2	36.7	40.6	5	53.3	225.1
* PKS36A	PKS36CA	36	2	40.0	44.2	5	58.1	206.5
PKS43A	PKS43CA	43	2	47.8	52.8	5	69.4	172.9

Test ISO 16750-2 Test A

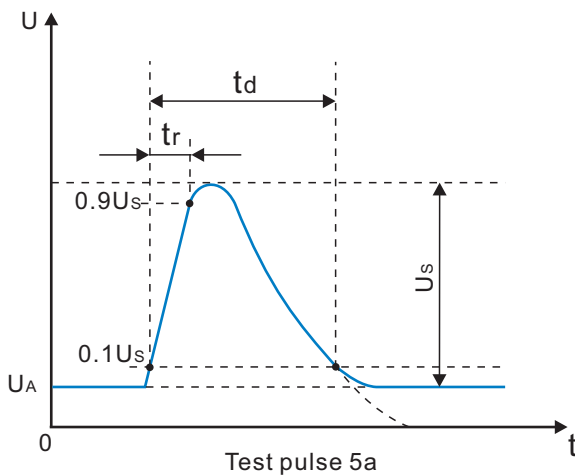

Parameter	12V System	24V System
U_s	79V to 101V	151V to 202V
R_i	0.5 Ω to 4 Ω	1 Ω to 8 Ω
t_d	40ms to 400ms	100ms to 350ms
t_r	$(10^0_{-5})ms$	

Ratings and Characteristic Curves (TA=25 °C unless otherwise noted)

Fig.1 Peak Pulse Power Rating Curve

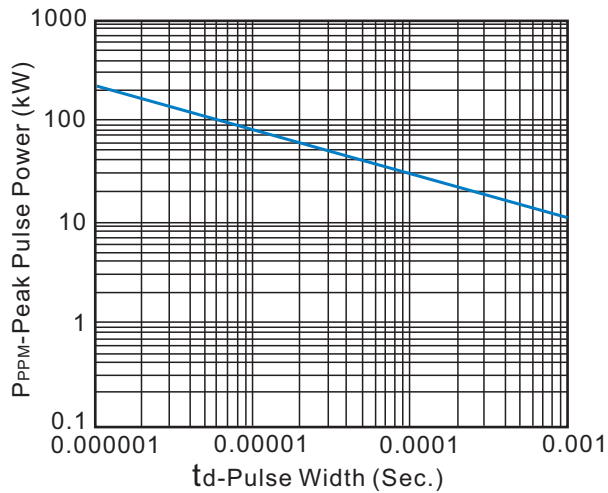

Fig.2 Typical Junction Capacitance

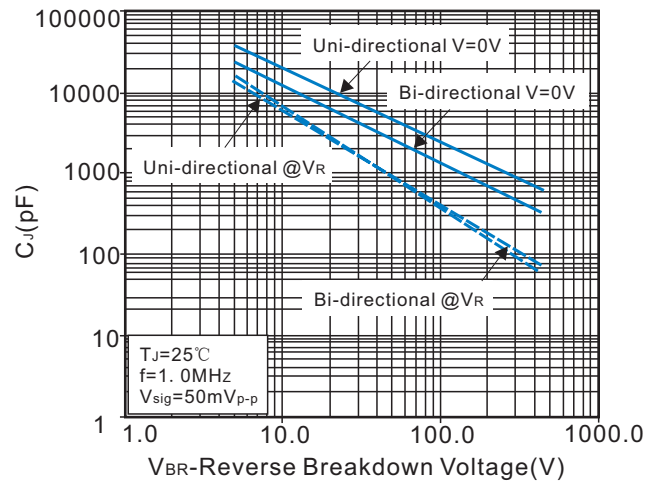

Fig.3 Pulse Waveform

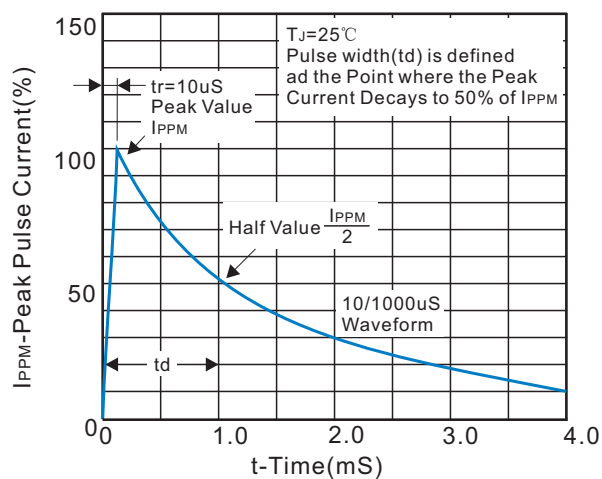

Fig.4 Maximum Non-repetitive Forward Surge

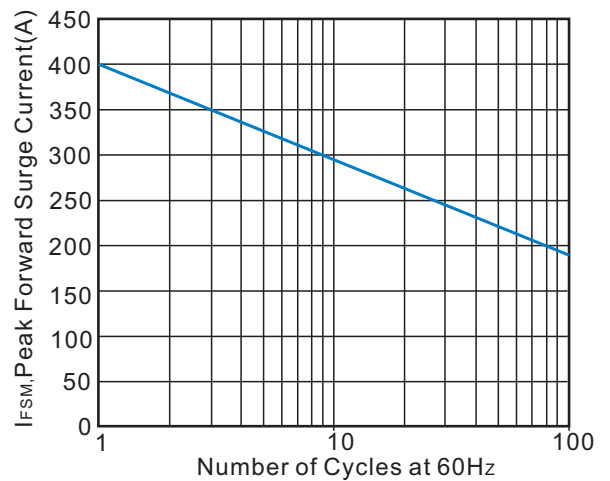

Fig.5 Ri-Vs chart for ISO-16750-2 Test A : 12V System

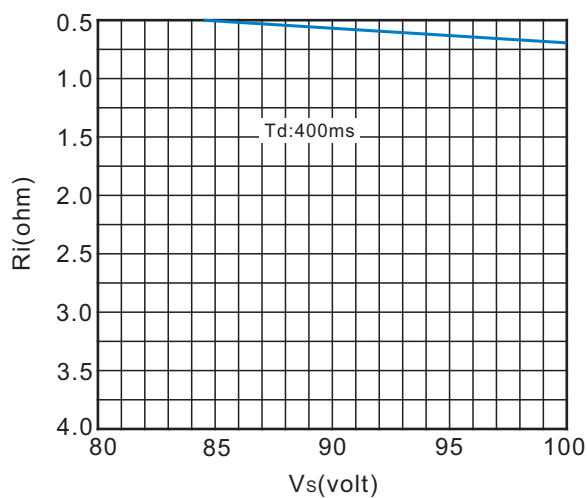
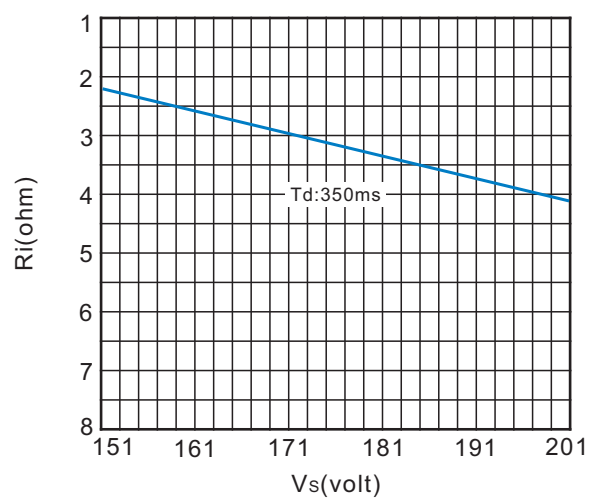
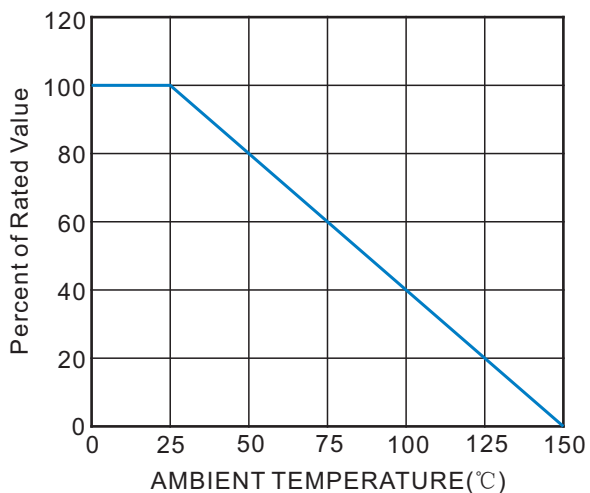

Fig.6 Ri-Vs chart for ISO-16750-2 Test A : 24V System



Ratings and Characteristic Curves (TA=25 °C unless otherwise noted)

Fig.7 Power Derating Curve



Recommended Soldering Conditions

Recommended Conditions

Reflow Condition		
Pre Heat	-Temperature Min($T_{s(min)}$)	+150°C
	-Temperature Max($T_{s(max)}$)	+200°C
	-Time(Min to Max)(t_s)	60-180secs
Average ramp up rate (Liquidus Temp(T_L) to peak)		3°C/sec.Max.
$T_{s(max)}$ to T_L -Ramp-up Rate		3°C/sec.Max.
Reflow	-Temperature(T_L)(Liquidus)	+217°C
	-Temperature(t_L)	60-150secs
Peak Temp(T_P)		+260(+0/-5)°C
Time within 5°C of actual Peak Temp(t_P)		30 secs.Max.
Ramp-down Rate		6°C/sec.Max.
Time 25°C to Peak Temp(T_P)		8 min.Max.
Do not exceed		+260°C

Reflow Soldering

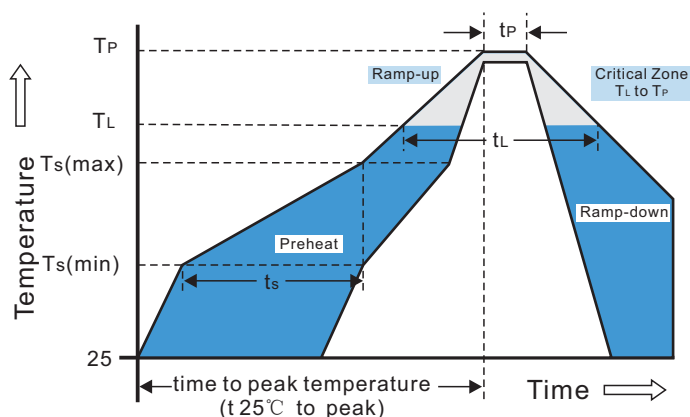

Marking Code

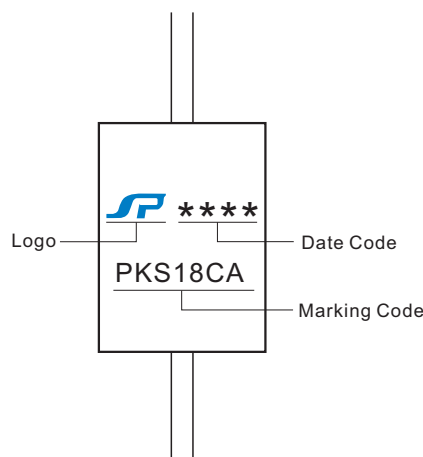
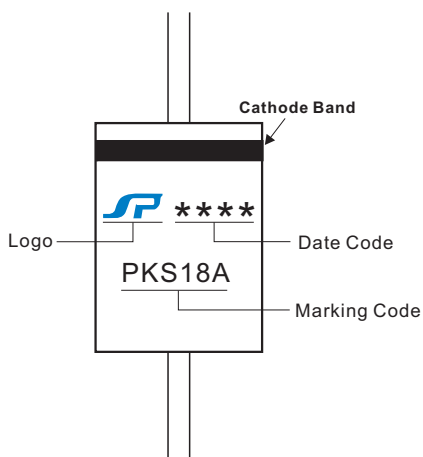

Packaging

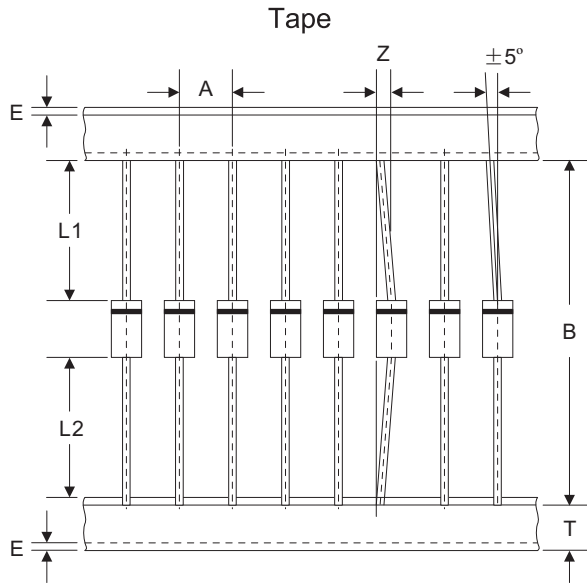

Box

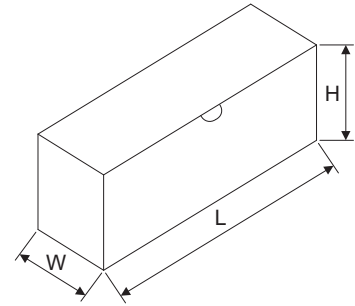

Dimensions in millimeters

A	B	Z	T	E	L1-L2
10.0±0.5	52.0±0.5	1.2Max	6.0±0.4	1.0Max	1.0Max

L	W	H	Quantity
250.0±5.0	78.0±5.0	114.0±5.0	300PCS