

100V(D-S) N-Channel Enhancement Mode Power MOS FET

General Features

- $V_{DS} = 100V, I_D = 30A$
 $R_{DS(ON)} < 31m\Omega @ V_{GS}=10V$ (Typ:27m Ω)
- Special process technology for high ESD capability
- High density cell design for ultra low R_{dson}
- Fully characterized avalanche voltage and current
- Good stability and uniformity with high E_{AS}
- Excellent package for good heat dissipation



Lead Free

Application

- Power switching application
- Hard switched and high frequency circuits
- Uninterruptible power supply

PIN Configuration

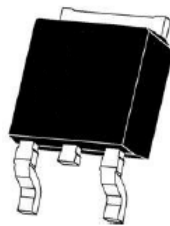

TO-252 -2L top view

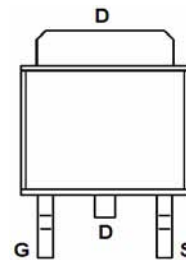

Marking and pin assignment

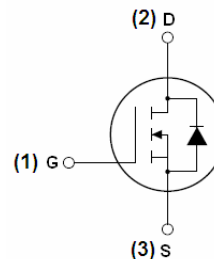

Schematic diagram

Package Marking and Ordering Information

Device Marking	Device	Device Package	Reel Size	Tape width	Quantity
MSN1030D	MSN1030D	TO-252-2L	-	-	-

Absolute Maximum Ratings ($T_C=25^\circ C$ unless otherwise noted)

Symbol	Parameter	Limit	Unit
V_{DS}	Drain-Source Voltage	100	V
V_{GS}	Gate-Source Voltage	± 20	V
I_D	Drain Current-Continuous	30	A
$I_D(100^\circ C)$	Drain Current-Continuous($T_C=100^\circ C$)	21	A
I_{DM}	Pulsed Drain Current	70	A
P_D	Maximum Power Dissipation	85	W
	Derating factor	0.57	W/ $^\circ C$
E_{AS}	Single pulse avalanche energy ^(Note 5)	256	mJ
T_J, T_{STG}	Operating Junction and Storage Temperature Range	-55 To 175	$^\circ C$

Thermal Characteristic

$R_{\theta JC}$	Thermal Resistance, Junction-to-Case ^(Note 2)	1.8	$^{\circ}C/W$
-----------------	--	-----	---------------

Electrical Characteristics ($T_C=25^{\circ}C$ unless otherwise noted)

Symbol	Parameter	Condition	Min	Typ	Max	Unit
Off Characteristics						
BV_{DSS}	Drain-Source Breakdown Voltage	$V_{GS}=0V, I_D=250\mu A$	100	115	-	V
I_{DSS}	Zero Gate Voltage Drain Current	$V_{DS}=100V, V_{GS}=0V$	-	-	1	μA
I_{GSS}	Gate-Body Leakage Current	$V_{GS}=\pm 20V, V_{DS}=0V$	-	-	± 100	nA
On Characteristics ^(Note 3)						
$V_{GS(th)}$	Gate Threshold Voltage	$V_{DS}=V_{GS}, I_D=250\mu A$	1.3	1.9	2.5	V
$R_{DS(ON)}$	Drain-Source On-State Resistance	$V_{GS}=10V, I_D=10A$	-	27	31	m Ω
g_{FS}	Forward Transconductance	$V_{DS}=5V, I_D=10A$	-	15	-	S
Dynamic Characteristics ^(Note 4)						
C_{ISS}	Input Capacitance	$V_{DS}=25V, V_{GS}=0V,$ $F=1.0MHz$	-	2000	-	PF
C_{OSS}	Output Capacitance		-	300	-	PF
C_{RSS}	Reverse Transfer Capacitance		-	250	-	PF
Switching Characteristics ^(Note 4)						
$t_{d(on)}$	Turn-on Delay Time	$V_{DD}=50V, R_L=5\Omega$ $V_{GS}=10V, R_{GEN}=3\Omega$	-	7	-	nS
t_r	Turn-on Rise Time		-	7	-	nS
$t_{d(off)}$	Turn-Off Delay Time		-	29	-	nS
t_f	Turn-Off Fall Time		-	7	-	nS
Q_g	Total Gate Charge	$V_{DS}=50V, I_D=10A,$ $V_{GS}=10V$	-	39	-	nC
Q_{gs}	Gate-Source Charge		-	8	-	nC
Q_{gd}	Gate-Drain Charge		-	12	-	nC
Drain-Source Diode Characteristics						
V_{SD}	Diode Forward Voltage ^(Note 3)	$V_{GS}=0V, I_S=10A$	-	-	1.2	V
I_S	Diode Forward Current ^(Note 2)	-	-	-	30	A
t_{rr}	Reverse Recovery Time	$T_J = 25^{\circ}C, I_F = 10A$ $di/dt = 100A/\mu s$ ^(Note 3)	-	32	-	nS
Q_{rr}	Reverse Recovery Charge		-	53	-	nC
t_{on}	Forward Turn-On Time	Intrinsic turn-on time is negligible (turn-on is dominated by LS+LD)				

Notes:

1. Repetitive Rating: Pulse width limited by maximum junction temperature.
2. Surface Mounted on FR4 Board, $t \leq 10$ sec.
3. Pulse Test: Pulse Width $\leq 300\mu s$, Duty Cycle $\leq 2\%$.
4. Guaranteed by design, not subject to production
5. EAS Condition : $T_J=25^{\circ}C, V_{DD}=50V, V_G=10V, L=0.5mH, R_g=25\Omega, I_{AS}=32A$

Test Circuit

1) E_{AS} Test Circuit

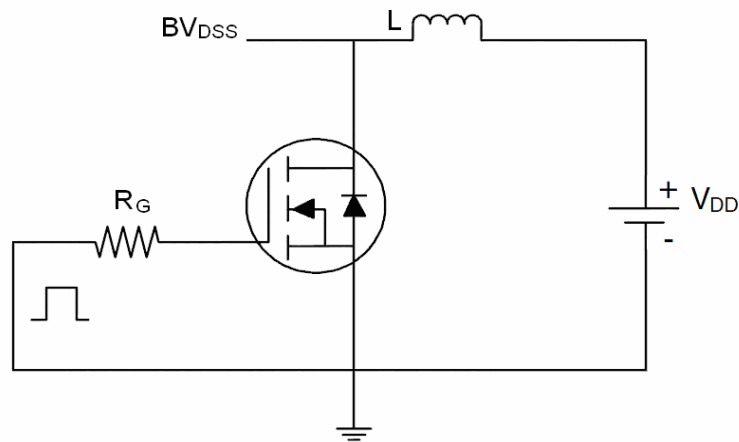

2) Gate Charge Test Circuit

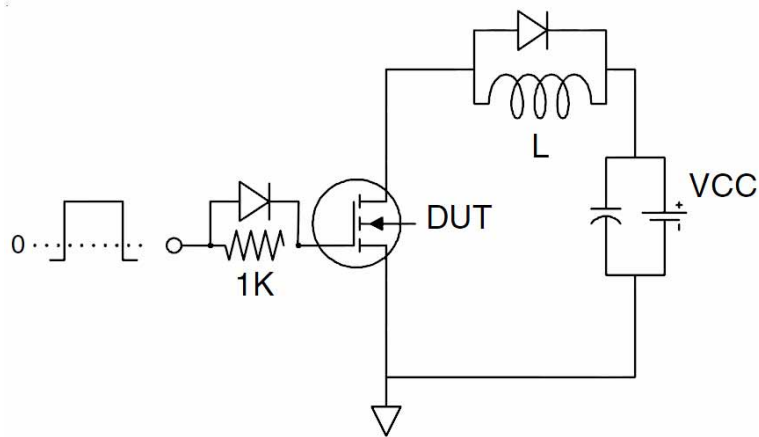

3) Switch Time Test Circuit

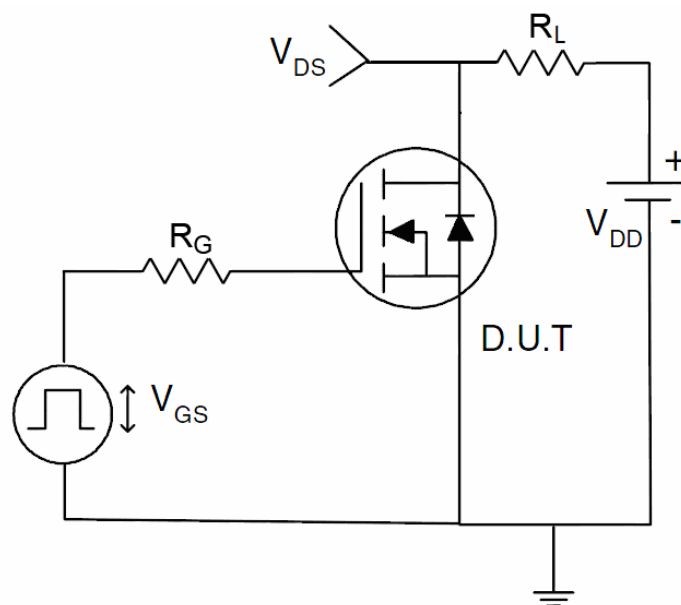

Typical Electrical and Thermal Characteristics (Curves)

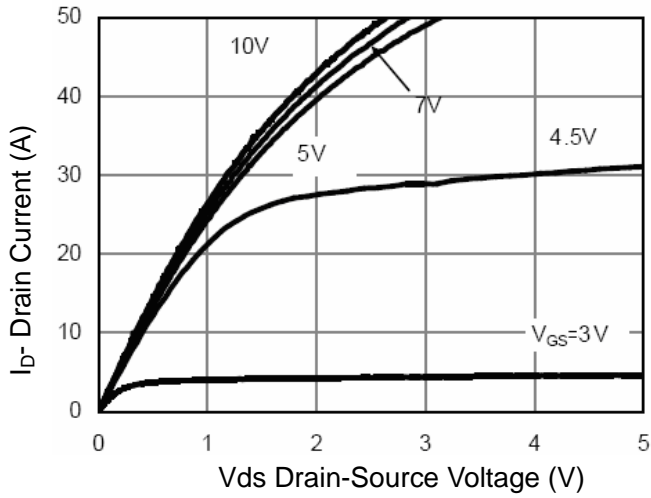

Figure 1 Output Characteristics

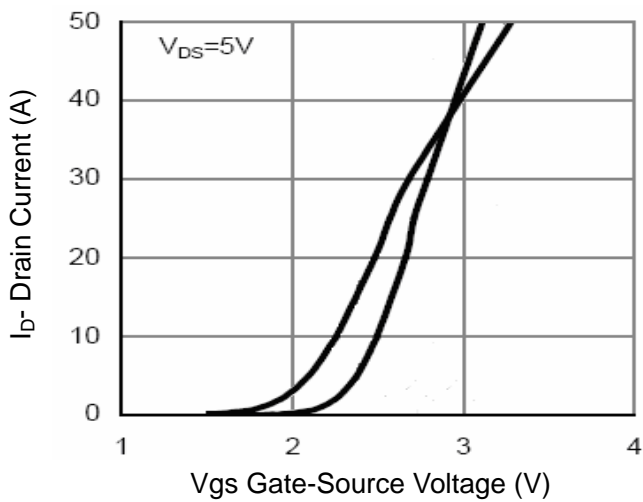

Figure 2 Transfer Characteristics

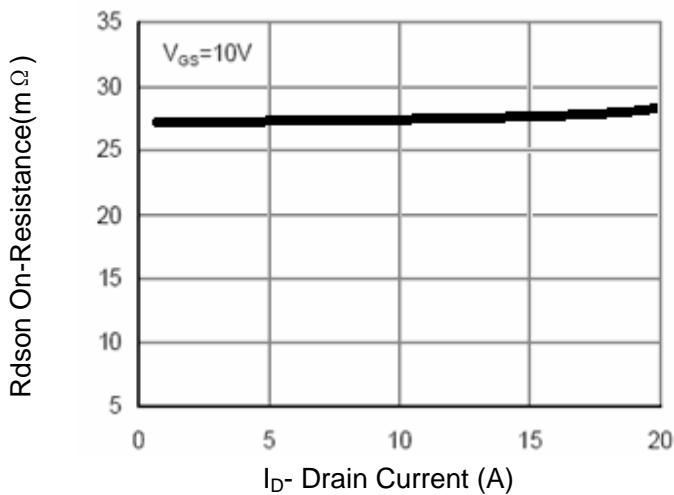

Figure 3 Rdson- Drain Current

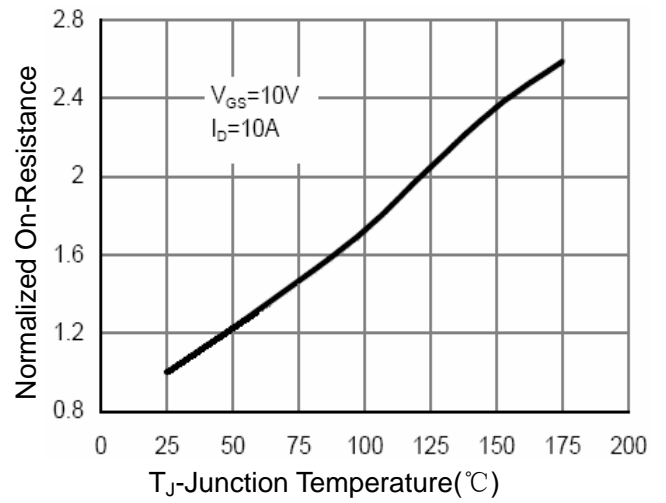

Figure 4 Rdson-Junction Temperature

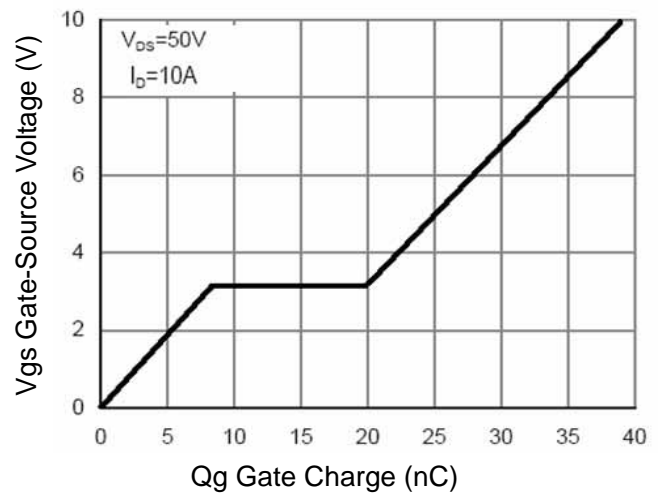

Figure 5 Gate Charge

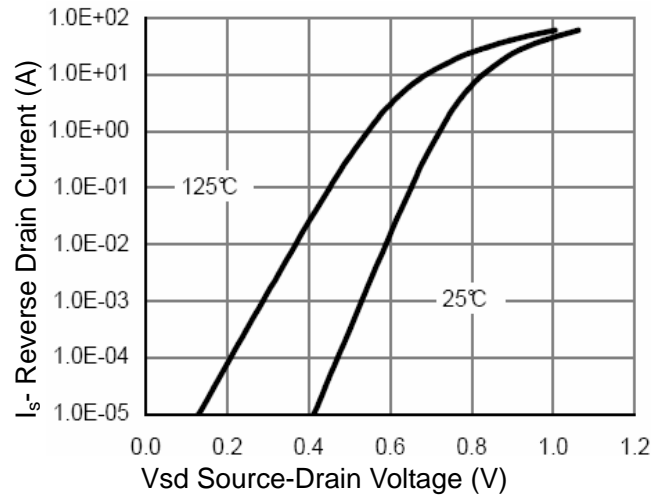

Figure 6 Source- Drain Diode Forward

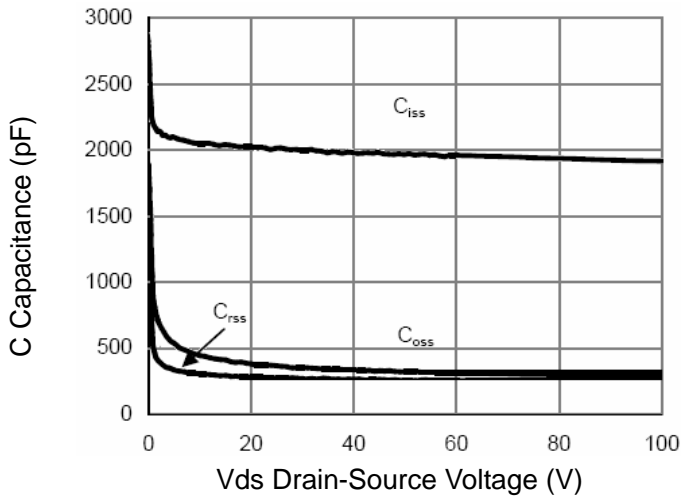

Figure 7 Capacitance vs Vds

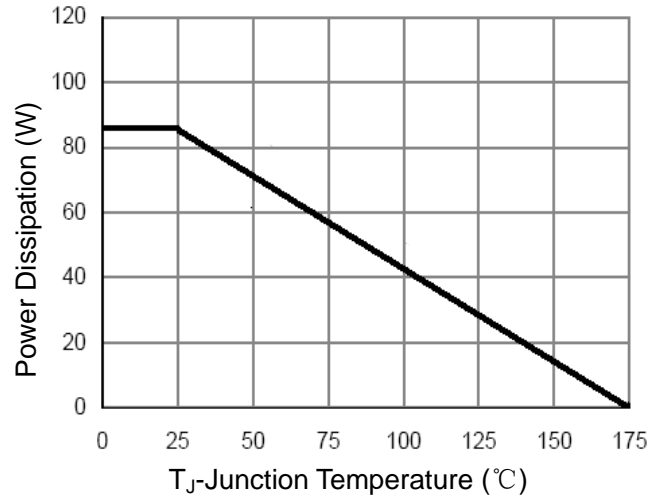

Figure 9 Power De-rating

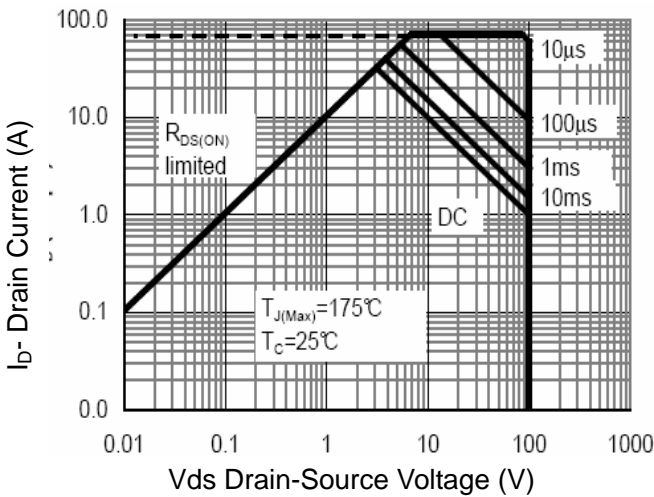

Figure 8 Safe Operation Area

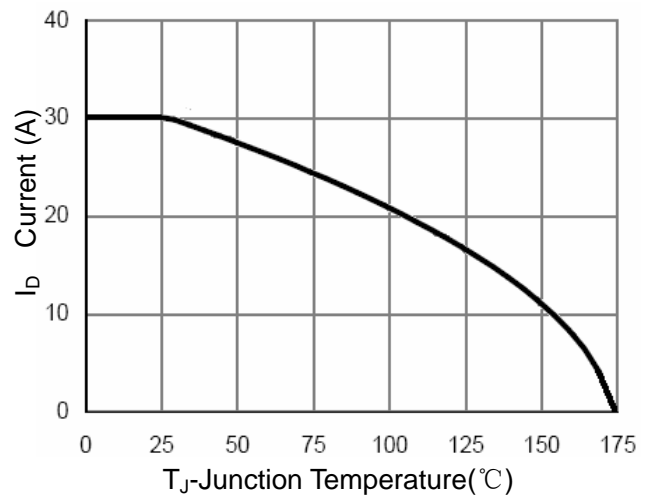

Figure 10 ID Current- Junction Temperature

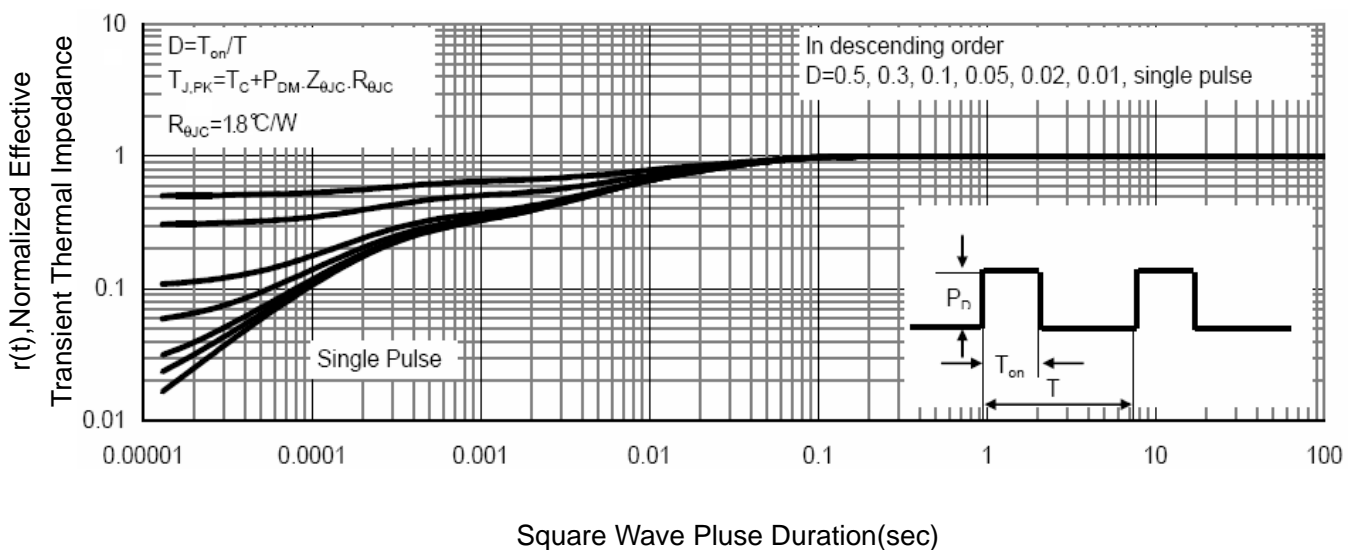
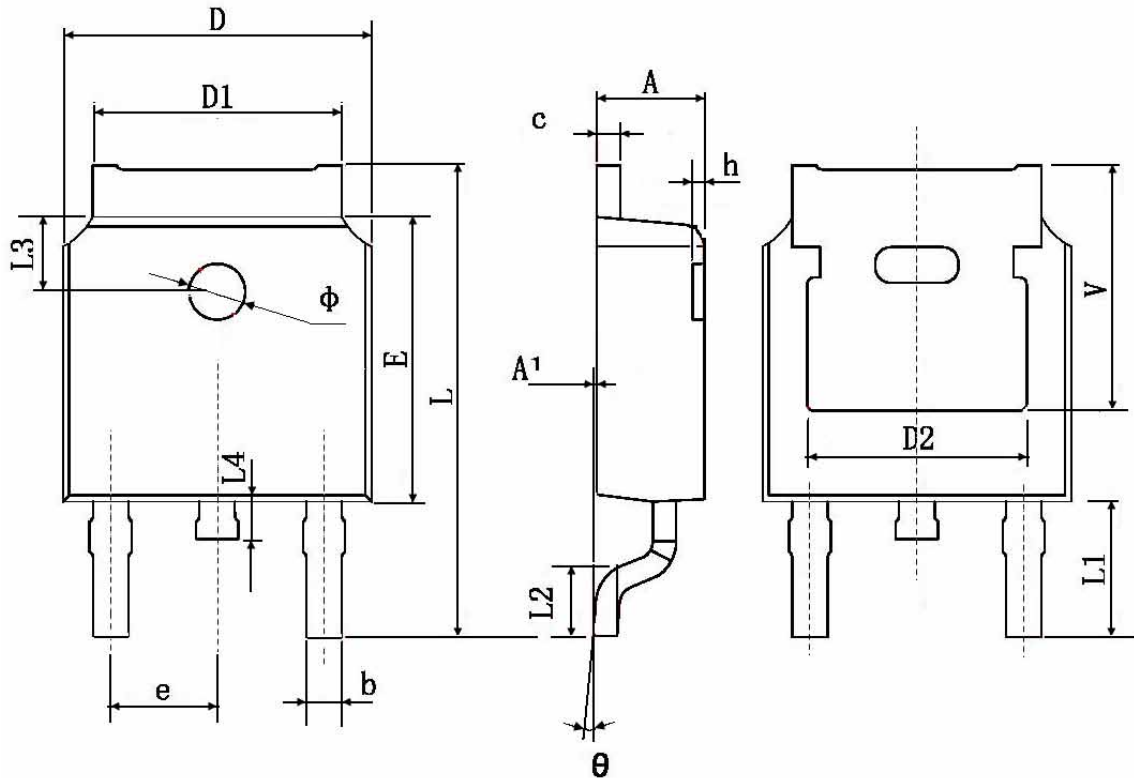

Figure 11 Normalized Maximum Transient Thermal Impedance

TO-252 Package Information



Symbol	Dimensions In Millimeters		Dimensions In Inches	
	Min.	Max.	Min.	Max.
A	2.200	2.400	0.087	0.094
A1	0.000	0.127	0.000	0.005
b	0.660	0.860	0.026	0.034
c	0.460	0.580	0.018	0.023
D	6.500	6.700	0.256	0.264
D1	5.100	5.460	0.201	0.215
D2	4.830 TYP.		0.190 TYP.	
E	6.000	6.200	0.236	0.244
e	2.186	2.386	0.086	0.094
L	9.800	10.400	0.386	0.409
L1	2.900 TYP.		0.114 TYP.	
L2	1.400	1.700	0.055	0.067
L3	1.600 TYP.		0.063 TYP.	
L4	0.600	1.000	0.024	0.039
phi	1.100	1.300	0.043	0.051
theta	0°	8°	0°	8°
h	0.000	0.300	0.000	0.012
V	5.350 TYP.		0.211 TYP.	