

M54534P/FP

6-UNIT 320mA TRANSISTOR ARRAY WITH CLAMP DIODE AND STROBE

DESCRIPTION

M54534P and M54534FP are six-circuit transistor arrays. The circuits are made of NPN transistors. Both the semiconductor integrated circuits perform high-current driving with extremely low input-current supply.

FEATURES

- Medium breakdown voltage ($BV_{CEO} \geq 20V$)
- High-current driving ($I_{c(max)} = 320mA$)
- With clamping diodes
- Wide input voltage range ($V_I = -25$ to $+20V$)
- Wide operating temperature range ($T_a = -20$ to $+75^\circ C$)
- With strobe input

APPLICATION

Drives of relays and printers, digit drives of indication elements (LEDs and lamps).

FUNCTION

The M54534P and M54534FP each have six circuits consisting of NPN transistors. Each input has a diode and $1.6k\Omega$ resistor in series. Each input is connected, and each output is connected spike-killer clamping diode, emitters of each transistor is connected to GND (pin 8), strobe input is connected to (pin 1), clamping diode is connected COM pin (pin 9) and V_{cc} is connected to the pin 16 in common. The collector current is 320mA maximum. Collector-emitter supply voltage is 20V maximum. M54534FP is enclosed in a molded small flat package, enabling space-saving design.

PIN CONFIGURATION (TOP VIEW)

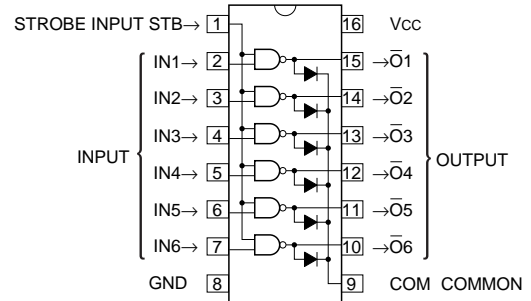

16P4(P)
Outline 16P2N-A(FP)

CIRCUIT SCHEMATIC (EACH CIRCUIT)

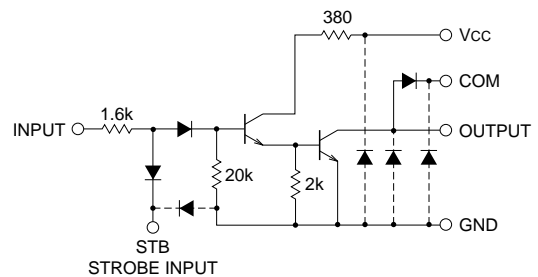

The six circuits share the STB, COM, V_{cc} , GND.

The diodes shown by broken line are parasite diodes and must not be use.

Unit : Ω

ABSOLUTE MAXIMUM RATINGS (Unless otherwise noted, $T_a = -20 \sim +75^\circ C$)

Symbol	Parameter	Conditions	Ratings	Unit
V_{CC}	Supply voltage		10	V
V_{CEO}	Collector-emitter voltage	Output, H	$-0.5 \sim +20$	V
I_C	Collector current	Current per circuit output, L	320	mA
V_I	Input voltage		$-25 \sim +20$	V
$V_{(STB)}$	Strobe input voltage		$-0.5 \sim +20$	V
I_F	Clamping diode forward current		320	mA
V_R	Clamping diode reverse voltage		20	V
P_d	Power dissipation	$T_a = 25^\circ C$, when mounted on board	1.47/1.00	W
T_{opr}	Operating temperature		$-20 \sim +75$	$^\circ C$
T_{stg}	Storage temperature		$-55 \sim +125$	$^\circ C$

6-UNIT 320mA TRANSISTOR ARRAY WITH CLAMP DIODE AND STROBE

FUNCTIONAL TABLE

IN	STB	OUT
L	L	H
H	L	H
L	H	H
H	H	L

RECOMMENDED OPERATING CONDITIONS (Unless otherwise noted, Ta = -20 ~ +75°C)

Symbol	Parameter	Limits			Unit	
		min	typ	max		
V _{CC}	Supply voltage	3	—	8	V	
V _O	Output voltage	0	—	20	V	
I _C	Collector current Per channel	V _{CC} = 6.5V, Duty Cycle P : no more than 25% FP : no more than 15%	0	—	300	mA
		V _{CC} = 6.5V, Duty Cycle P : no more than 65% FP : no more than 35%	0	—	150	
V _{IH}	"H" Input voltage	3.2	—	18	V	
V _{IL}	"L" Input voltage	0	—	0.7	V	
V _{IH(STB)}	"H" Input voltage (strobe input)	2.4	—	18	V	
V _{IL(STB)}	"L" Input voltage (strobe input)	0	—	0.2	V	

ELECTRICAL CHARACTERISTICS (Unless otherwise noted, Ta = -20 ~ +75°C)

Symbol	Parameter	Test conditions	Limits			Unit
			min	typ*	max	
V (BR) CEO	Collector-emitter breakdown voltage	V _{CC} = 8V, V _I = 3.2V, V _{I(STB)} = 0.2V, I _{CEO} = 100μA	20	—	—	V
V _{CE(sat)}	Collector-emitter saturation voltage	V _I = 3.2V V _{I(STB)} = 2.4V	—	0.3	0.85	V
		V _{CC} = 6.5V, I _C = 250mA V _{CC} = 3V, I _C = 120mA	—	0.15	0.5	
I _I	Input current	V _{CC} = 8V, V _I = 3.2V, V _{I(STB)} = 2.4V	—	0.5	1.4	mA
I _{IR}	Input reverse current	V _{CC} = 8V, V _I = -25V	—	—	-20	μA
I _{I(STB)}	Strobe input current	V _{CC} = 8V, V _I = 3.2V (all input), V _{I(STB)} = 0.2V	—	-7.9	-20	mA
I _{R(STB)}	Strobe input reverse current	V _{CC} = 8V, V _I = 0V, V _{I(STB)} = 20V	—	—	20	μA
V _F	Clamping diode forward voltage	I _F = 320mA	—	1.4	2.4	V
I _R	Clamping diode reverse current	V _R = 20V	—	—	100	μA
I _{CC}	Supply current	V _{CC} = 8V, V _I = 3.2V (all input), V _{I(STB)} = 2.4V	—	120	200	mA
h _{FE}	DC amplification factor	V _{CE} = 4V, V _{CC} = 6.5V, I _C = 300mA, Ta = 25°C, V _{I(STB)} = 2.4V	1000	3000	—	—

* : The typical values are those measured under ambient temperature (Ta) of 25°C. There is no guarantee that these values are obtained under any conditions.

SWITCHING CHARACTERISTICS (Unless otherwise noted, Ta = 25°C)

Symbol	Parameter	Test conditions	Limits			Unit
			min	typ	max	
t _{on}	Turn-on time	C _L = 15pF (note 1)	—	22	—	ns
t _{off}	Turn-off time		—	1200	—	ns

M54534P/FP

6-UNIT 320mA TRANSISTOR ARRAY WITH CLAMP DIODE AND STROBE

NOTE 1 TEST CIRCUIT

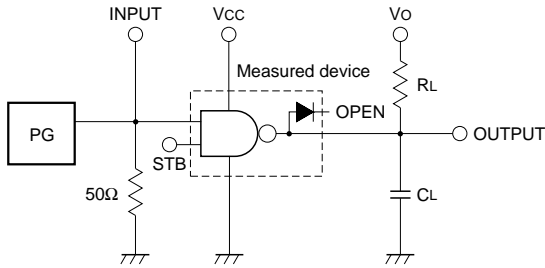

- (1) Pulse generator (PG) characteristics : PRR = 1kHz,
 $t_w = 10\mu s$, $t_r = 6ns$, $t_f = 6ns$, $Z_O = 50\Omega$
 $V_P = 3.2V_{P-P}$
- (2) Input-output conditions : $R_L = 40\Omega$, $V_O = 10V$, $V_{CC} = V_{STB} = 6.5V$
- (3) Electrostatic capacity C_L includes floating capacitance at connections and input capacitance at probes

TIMING DIAGRAM

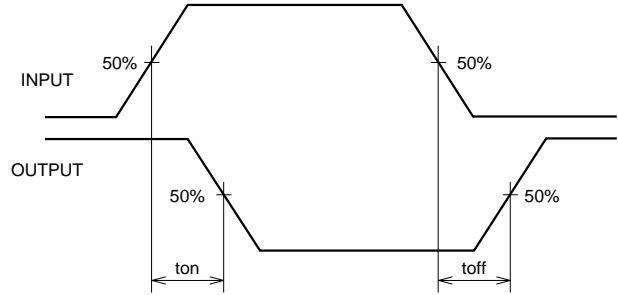

TYPICAL CHARACTERISTICS

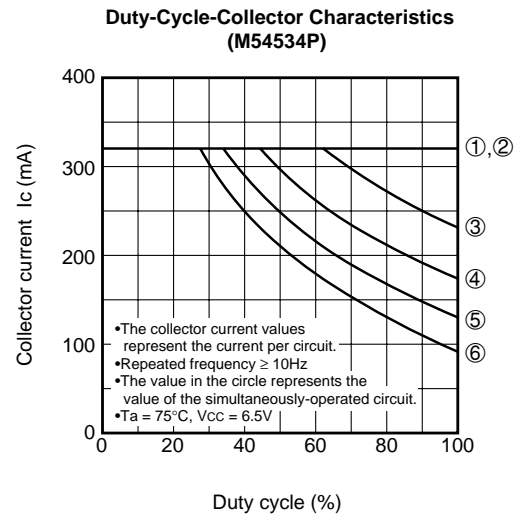
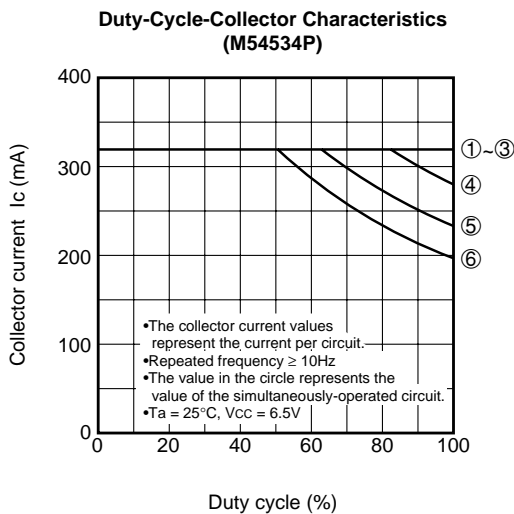
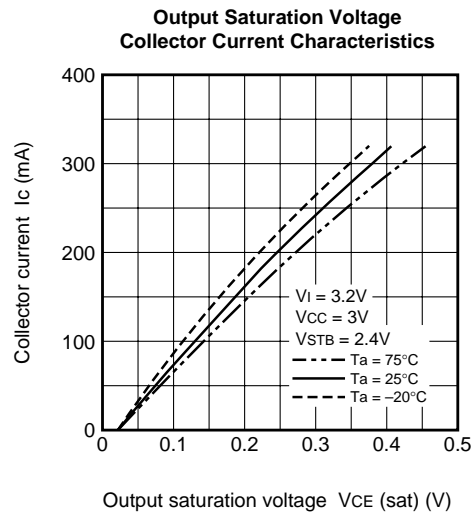
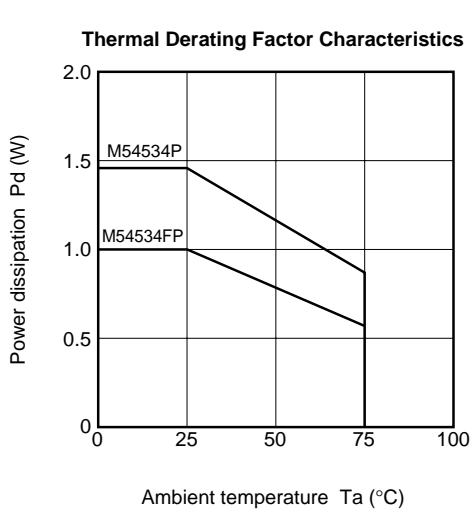

M54534P/FP

6-UNIT 320mA TRANSISTOR ARRAY WITH CLAMP DIODE AND STROBE

Duty-Cycle-Collector Characteristics (M54534FP)

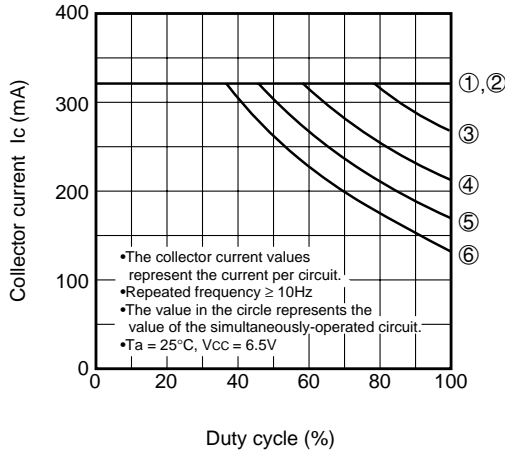

Duty-Cycle-Collector Characteristics (M54534FP)

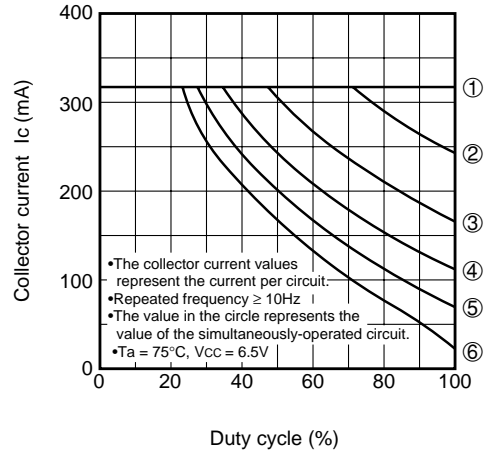

DC Amplification Factor Collector Current Characteristics

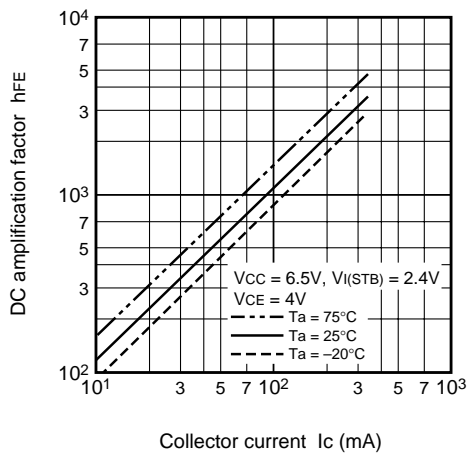

Grounded Emitter Transfer Characteristics

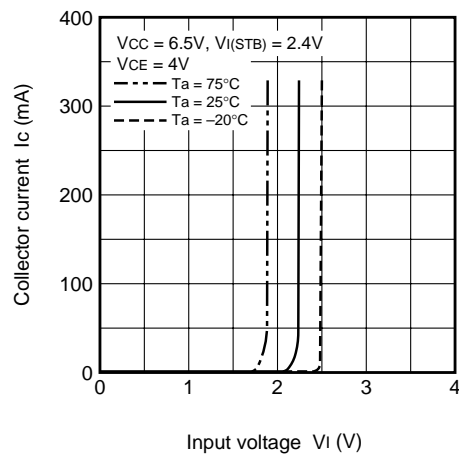

Input Characteristics

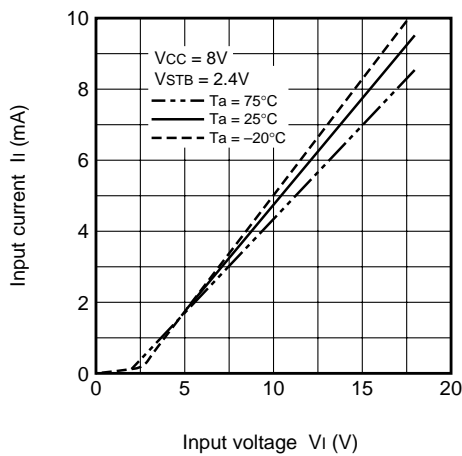

Supply Current Characteristics (common)

