



N-CHANNEL MOSFET

Qualified per MIL-PRF-19500/555

Qualified Levels:
JAN, JANTX, and
JANTXV

DESCRIPTION

These 2N6788 and 2N6790 devices are military qualified up to a JANTXV level for high-reliability applications. Microsemi also offers numerous other products to meet higher and lower power voltage regulation applications.

Important: For the latest information, visit our website <http://www.microsemi.com>.

FEATURES

- JEDEC registered 2N6788 and 2N6790 number.
- JAN, JANTX, and JANTXV qualifications are available per MIL-PRF-19500/555.
- RoHS compliant versions available (commercial grade only).

APPLICATIONS / BENEFITS

- High frequency operation.
- Lightweight package.
- ESD rated to class 1A.

MAXIMUM RATINGS @ T_C = +25 °C unless otherwise noted

Parameters / Test Conditions	Symbol	Value	Unit	
Junction & Storage Temperature	T _J , T _{stg}	-55 to +150	°C	
Thermal Resistance Junction-to-Case (see Figure 1)	R _{θJC}	6.25	°C/W	
Total Power Dissipation ⁽¹⁾	P _T	0.8	W	
Drain to Gate Voltage	V _{DG}	2N6788 2N6790	100 200	V
Drain – Source Voltage		V _{DS}	2N6788 2N6790	100 200
Gate – Source Voltage	V _{GS}		± 20	V
Drain Current, dc @ T _C = +25 °C ⁽²⁾ (see Figure ?)	I _{D1}	2N6788 2N6790	6.0 3.5	A
Drain Current, dc @ T _C = +100 °C		I _{D2}	2N6788 2N6790	3.5 2.25
Off-State Current ⁽³⁾	I _{DM}		2N6788 2N6790	24 14
Source Current		I _S	2N6788 2N6790	6.0 3.5

- Notes:**
1. Derated linearly by 0.16 W/°C for T_C > +25 °C.
 2. The following formula derives the maximum theoretical I_D limit. I_D is also limited by package and internal wires and may be limited due to pin diameter.

$$I_D = \sqrt{\frac{T_J(\text{max}) - T_C}{R_{\theta JC} \times R_{DS(\text{on})} @ T_J(\text{max})}}$$

3. I_{DM} = 4 x I_{D1}; I_{D1} as calculated in note 2.

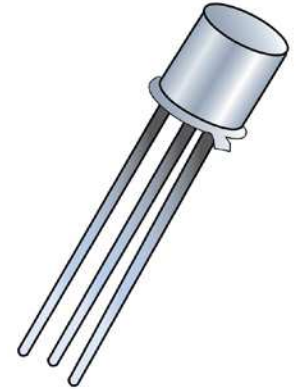

TO-205AF
(formerly TO-39)
Package

Also available in:

U-18 LCC Package
(surface mount)
 [2N6788U & 2N6790U](#)

MSC – Lawrence

6 Lake Street,
Lawrence, MA 01841
Tel: 1-800-446-1158 or
(978) 620-2600
Fax: (978) 689-0803

MSC – Ireland

Gort Road Business Park,
Ennis, Co. Clare, Ireland
Tel: +353 (0) 65 6840044
Fax: +353 (0) 65 6822298

Website:

www.microsemi.com

MECHANICAL and PACKAGING

- CASE: Hermetically sealed, kovar base, nickel cap.
- TERMINALS: Tin/lead solder dip nickel plate or RoHS compliant pure tin plate (commercial grade only).
- MARKING: Part number, date code, manufacturer's ID.
- WEIGHT: Approximately 1.064 grams.
- See [Package Dimensions](#) on last page.

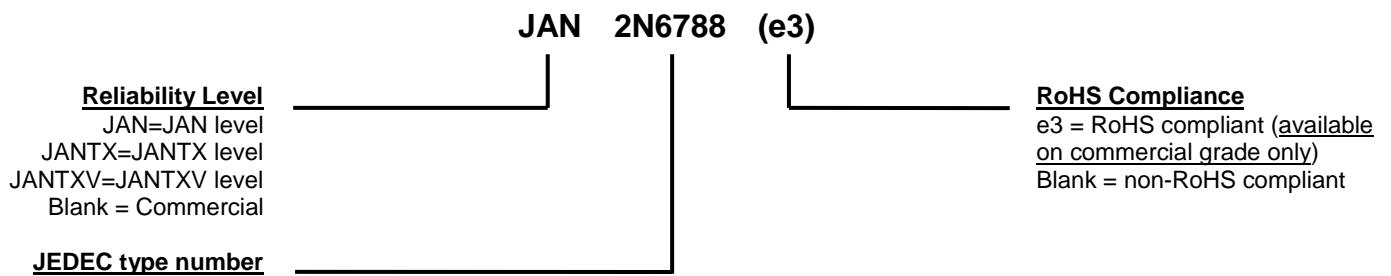
PART NOMENCLATURE

SYMBOLS & DEFINITIONS

Symbol	Definition
I_D	Drain current.
I_F	Forward current.
T_C	Case temperature.
V_{DD}	Drain supply voltage.
V_{DS}	Drain to source voltage.
V_{GS}	Gate to source voltage.

ELECTRICAL CHARACTERISTICS @ $T_A = +25\text{ }^\circ\text{C}$, unless otherwise noted

Parameters / Test Conditions	Symbol	Min.	Max.	Unit
OFF CHARACTERISTICS				
Drain-Source Breakdown Voltage $V_{GS} = 0\text{ V}, I_D = 1\text{ mA}$	2N6788 2N6790 $V_{(BR)DSS}$	100 200		V
Gate-Source Voltage (Threshold) $V_{DS} \geq V_{GS}, I_D = 0.25\text{ mA}$ $V_{DS} \geq V_{GS}, I_D = 0.25\text{ mA}, T_j = +125\text{ }^\circ\text{C}$ $V_{DS} \geq V_{GS}, I_D = 0.25\text{ mA}, T_j = -55\text{ }^\circ\text{C}$	$V_{GS(th)1}$ $V_{GS(th)2}$ $V_{GS(th)3}$	2.0 1.0	4.0 5.0	V
Gate Current $V_{GS} = \pm 20\text{ V}, V_{DS} = 0\text{ V}$ $V_{GS} = \pm 20\text{ V}, V_{DS} = 0\text{ V}, T_j = +125\text{ }^\circ\text{C}$	I_{GSS1} I_{GSS2}		± 100 ± 200	nA

Parameters / Test Conditions	Symbol	Min.	Max.	Unit
ON CHARACTERISTICS				
Drain Current $V_{GS} = 0\text{ V}, V_{DS} = 80\text{ V}$ $V_{GS} = 0\text{ V}, V_{DS} = 160\text{ V}$	2N6788 2N6790 I_{DSS1}		25	μA
Drain Current $V_{GS} = 0\text{ V}, V_{DS} = 80\text{ V}, T_j = +125\text{ }^\circ\text{C}$ $V_{GS} = 0\text{ V}, V_{DS} = 160\text{ V}, T_j = +125\text{ }^\circ\text{C}$	2N6788 2N6790 I_{DSS2}		0.25	mA
Static Drain-Source On-State Resistance $V_{GS} = 10\text{ V}, I_D = 3.5\text{ A pulsed}$ $V_{GS} = 10\text{ V}, I_D = 2.25\text{ A pulsed}$	2N6788 2N6790 $r_{DS(on)1}$		0.30 0.80	Ω
Static Drain-Source On-State Resistance $V_{GS} = 10\text{ V}, I_D = 6.0\text{ A pulsed}$ $V_{GS} = 10\text{ V}, I_D = 3.5\text{ A pulsed}$	2N6788 2N6790 $r_{DS(on)2}$		0.35 0.85	Ω
Static Drain-Source On-State Resistance $T_j = +125\text{ }^\circ\text{C}$: $V_{GS} = 10\text{ V}, I_D = 3.5\text{ A pulsed}$ $V_{GS} = 10\text{ V}, I_D = 2.25\text{ A pulsed}$	2N6788 2N6790 $r_{DS(on)3}$		0.54 1.50	Ω
Diode Forward Voltage $V_{GS} = 0\text{ V}, I_D = 6.0\text{ A pulsed}$ $V_{GS} = 0\text{ V}, I_D = 3.5\text{ A pulsed}$	2N6788 2N6790 V_{SD}		1.8 1.5	V

ELECTRICAL CHARACTERISTICS @ $T_A = +25\text{ }^\circ\text{C}$, unless otherwise noted (continued)
DYNAMIC CHARACTERISTICS

Parameters / Test Conditions	Symbol	Min.	Max.	Unit
Gate Charge:				
On-State Gate Charge $V_{GS} = 10\text{ V}$, $I_D = 6.0\text{ A}$, $V_{DS} = 50\text{ V}$ $V_{GS} = 10\text{ V}$, $I_D = 3.5\text{ A}$, $V_{DS} = 100\text{ V}$	$Q_{g(on)}$		18.0 14.3	nC
Gate to Source Charge $V_{GS} = 10\text{ V}$, $I_D = 6.0\text{ A}$, $V_{DS} = 50\text{ V}$ $V_{GS} = 10\text{ V}$, $I_D = 3.5\text{ A}$, $V_{DS} = 100\text{ V}$	Q_{gs}		4.0 3.0	nC
Gate to Drain Charge $V_{GS} = 10\text{ V}$, $I_D = 6.0\text{ A}$, $V_{DS} = 50\text{ V}$ $V_{GS} = 10\text{ V}$, $I_D = 3.5\text{ A}$, $V_{DS} = 100\text{ V}$	Q_{gd}		9.0 9.0	nC

SWITCHING CHARACTERISTICS

Parameters / Test Conditions	Symbol	Min.	Max.	Unit
Turn-on delay time $I_D = 6.0\text{ A}$, $V_{GS} = 10\text{ V}$, $R_G = 7.5\text{ }\Omega$, $V_{DD} = 35\text{ V}$ $I_D = 3.5\text{ A}$, $V_{GS} = 10\text{ V}$, $R_G = 7.5\text{ }\Omega$, $V_{DD} = 74\text{ V}$	$t_{d(on)}$		40	ns
Rinse time $I_D = 6.0\text{ A}$, $V_{GS} = 10\text{ V}$, $R_G = 7.5\text{ }\Omega$, $V_{DD} = 35\text{ V}$ $I_D = 3.5\text{ A}$, $V_{GS} = 10\text{ V}$, $R_G = 7.5\text{ }\Omega$, $V_{DD} = 74\text{ V}$	t_r		70 50	ns
Turn-off delay time $I_D = 6.0\text{ A}$, $V_{GS} = 10\text{ V}$, $R_G = 7.5\text{ }\Omega$, $V_{DD} = 35\text{ V}$ $I_D = 3.5\text{ A}$, $V_{GS} = 10\text{ V}$, $R_G = 7.5\text{ }\Omega$, $V_{DD} = 74\text{ V}$	$t_{d(off)}$		40 50	ns
Fall time $I_D = 6.0\text{ A}$, $V_{GS} = 10\text{ V}$, $R_G = 7.5\text{ }\Omega$, $V_{DD} = 35\text{ V}$ $I_D = 3.5\text{ A}$, $V_{GS} = 10\text{ V}$, $R_G = 7.5\text{ }\Omega$, $V_{DD} = 74\text{ V}$	t_f		70 50	ns
Diode Reverse Recovery Time $di/dt = 100\text{ A}/\mu\text{s}$, $V_{DD} \leq 50\text{ V}$, $I_F = 6.0\text{ A}$ $di/dt = 100\text{ A}/\mu\text{s}$, $V_{DD} \leq 50\text{ V}$, $I_F = 3.5\text{ A}$	t_{rr}		240 400	ns

GRAPHS

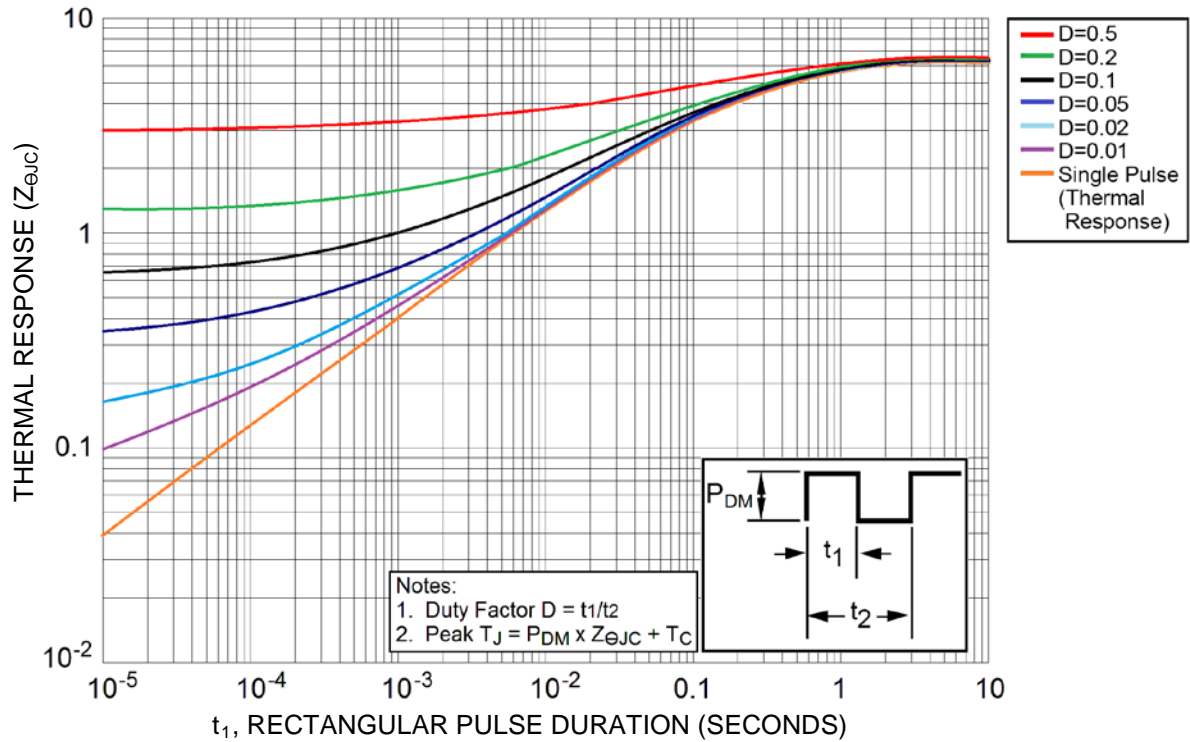

Figure 1
 Thermal Impedance Curves

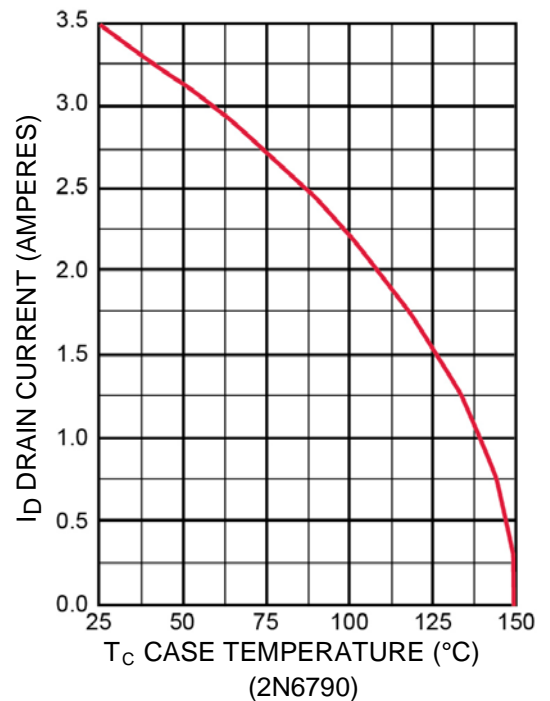
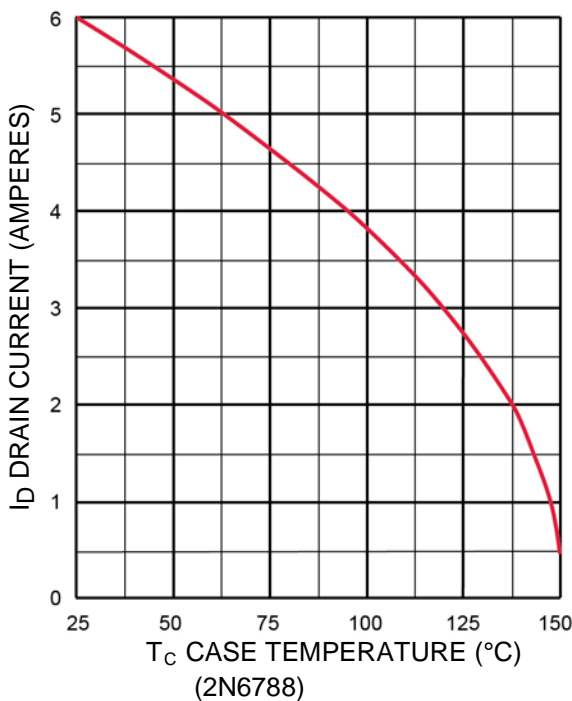
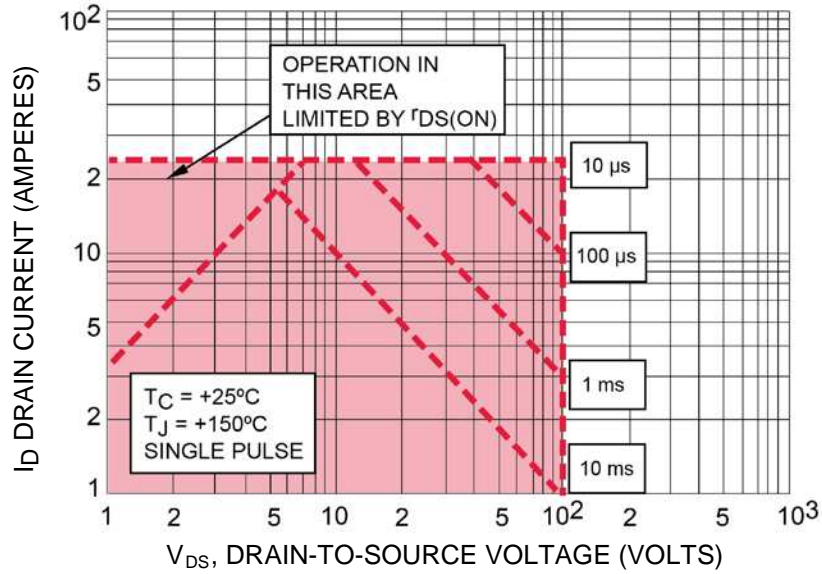
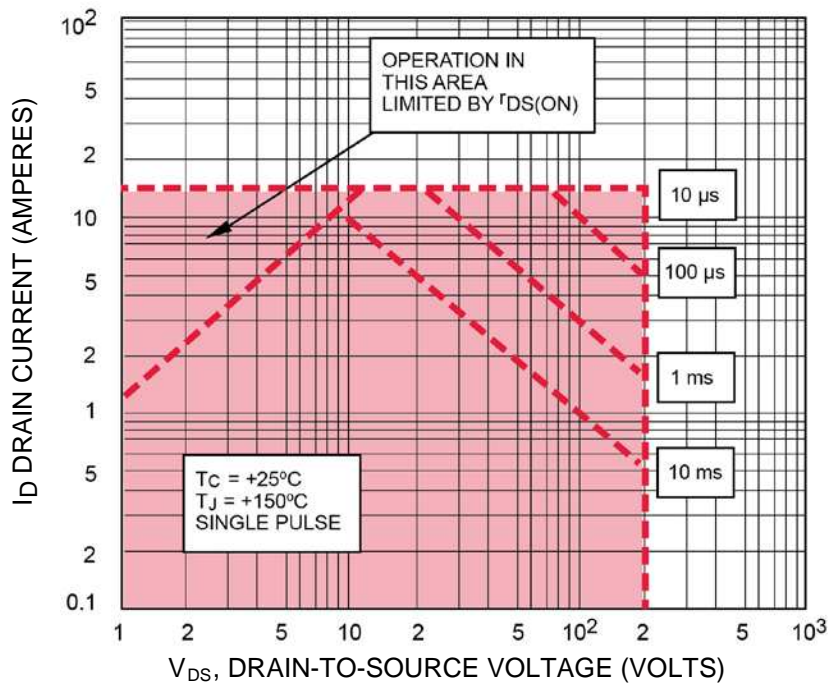

Figure 2
 Maximum Drain Current vs. Case Temperature Graph

GRAPHS (continued)



Maximum Safe Operating Area (2N6788)

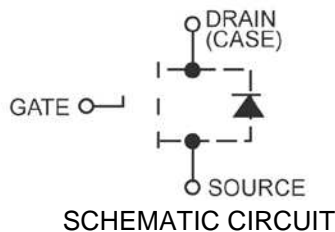
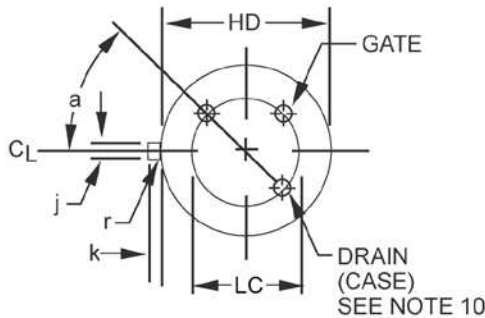
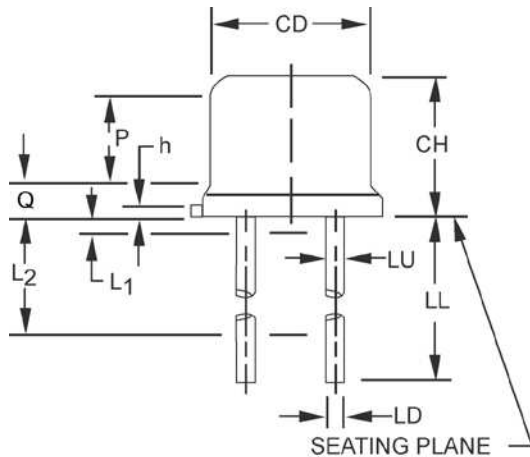

Maximum Safe Operating Area (2N6790)

PACKAGE DIMENSIONS

Ltr	Dimensions				Notes
	Inch		Millimeters		
	Min	Max	Min	Max	
CD	.305	.335	7.75	8.51	
CH	.160	.180	4.07	4.57	
HD	.335	.370	8.51	9.40	
h	.009	.041	0.23	1.04	
J	.028	.034	0.71	0.86	3
k	.029	.045	0.74	1.14	3, 4
LD	.016	.021	0.41	0.53	7, 8
LL	.500	.750	12.7	19.05	7, 8, 12
LS	.200 TP		5.08 TP		6
LU	.016	.019	0.41	0.48	7, 8
L1		.050		1.27	7, 8
L2	.250		6.35		7, 8
P	.100		2.54		
Q		.050		1.27	5
r		.010		0.25	10
α	45° TP		45° TP		6

NOTES:

1. Dimensions are in inches.
2. Millimeters are given for general information only.
3. Beyond r (radius) maximum, TL shall be held for a minimum length of .011 inch (0.28 mm).
4. Dimension TL measured from maximum HD.
5. Body contour optional within zone defined by HD, CD, and Q.
6. Leads at gauge plane .054 +.001 -.000 inch (1.37 +0.03 -0.00 mm) below seating plane shall be within .007 inch (0.18 mm) radius of true position (TP) at maximum material condition (MMC) relative to tab at MMC.
7. Dimension LU applies between L1 and L2. Dimension LD applies between L2 and LL minimum. Diameter is uncontrolled in L1 and beyond LL minimum.
8. All three leads.
9. The collector shall be internally connected to the case.
10. Dimension r (radius) applies to both inside corners of tab.
11. In accordance with ASME Y14.5M, diameters are equivalent to Φ x symbology.
12. Lead 1 = source, lead 2 = gate, lead 3 = drain.