

NDD03N80Z

N-Channel Power MOSFET

800 V, 4.5 Ω

Features

- ESD Diode-Protected Gate
- 100% Avalanche Tested
- 100% Rg Tested
- These Devices are Pb-Free, Halogen Free/BFR Free and are RoHS Compliant

ABSOLUTE MAXIMUM RATINGS (T_C = 25°C unless otherwise noted)

Rating	Symbol	Value	Unit
Drain-to-Source Voltage	V _{DSS}	800	V
Continuous Drain Current R _{θJC}	I _D	2.9	A
Continuous Drain Current R _{θJC} , T _A = 100°C	I _D	1.9	A
Pulsed Drain Current, V _{GS} @ 10 V	I _{DM}	12	A
Power Dissipation R _{θJC}	P _D	96	W
Gate-to-Source Voltage	V _{GS}	±30	V
Single Pulse Avalanche Energy, I _D = 2.5 A	E _{AS}	100	mJ
ESD (HBM) (JESD22-A114)	V _{esd}	2300	V
RMS Isolation Voltage (t = 0.3 sec., R.H. ≤ 30%, T _A = 25°C)	V _{ISO}	4500	V
Peak Diode Recovery (Note 1)	dv/dt	4.5	V/ns
Continuous Source Current (Body Diode)	I _S	3.3	A
Maximum Temperature for Soldering Leads	T _L	260	°C
Operating Junction and Storage Temperature Range	T _J , T _{stg}	-55 to 150	°C

Stresses exceeding Maximum Ratings may damage the device. Maximum Ratings are stress ratings only. Functional operation above the Recommended Operating Conditions is not implied. Extended exposure to stresses above the Recommended Operating Conditions may affect device reliability.

1. I_S = 3.3 A, di/dt ≤ 100 A/μs, V_{DD} ≤ BV_{DSS}, T_J = +150°C



ON Semiconductor®

<http://onsemi.com>

V _{(BR)DSS}	R _{DS(ON)} MAX
800 V	4.5 Ω @ 10 V

N-Channel

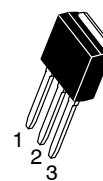
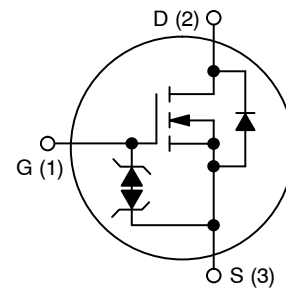

NDD03N80Z-1G
IPAK
CASE 369D

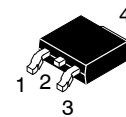

NDD03N80ZT4G
DPAK
CASE 369AA

MARKING AND ORDERING INFORMATION

See detailed ordering and shipping information in the package dimensions section on page 6 of this data sheet.

NDD03N80Z

THERMAL RESISTANCE

Parameter	Symbol	Value	Unit
Junction-to-Case (Drain)	$R_{\theta JC}$	1.3	°C/W
Junction-to-Ambient Steady State	(Note 3) NDD03N80Z (Note 2) NDD03N80Z-1	33 96	

2. Insertion mounted
3. Surface mounted on FR4 board using 1" sq. pad size (Cu area = 1.127" sq [2 oz] including traces).

ELECTRICAL CHARACTERISTICS ($T_J = 25^\circ\text{C}$ unless otherwise noted)

Characteristic	Symbol	Test Conditions	Min	Typ	Max	Unit
----------------	--------	-----------------	-----	-----	-----	------

OFF CHARACTERISTICS

Drain-to-Source Breakdown Voltage	$V_{(BR)DSS}$	$V_{GS} = 0\text{ V}, I_D = 1\text{ mA}$	800			V
Drain-to-Source Breakdown Voltage Temperature Coefficient	$V_{(BR)DSS}/T_J$	Reference to 25°C , $I_D = 1\text{ mA}$		870		mV/°C
Drain-to-Source Leakage Current	I_{DSS}	$V_{DS} = 800\text{ V}, V_{GS} = 0\text{ V}$	$T_J = 25^\circ\text{C}$		1.0	μA
			$T_J = 125^\circ\text{C}$		50	
Gate-to-Source Leakage Current	I_{GSS}	$V_{GS} = \pm 20\text{ V}$			± 10	μA

ON CHARACTERISTICS (Note 4)

Gate Threshold Voltage	$V_{GS(TH)}$	$V_{DS} = V_{GS}, I_D = 50\text{ }\mu\text{A}$	3.0	4.1	4.5	V
Negative Threshold Temperature Coefficient	$V_{GS(TH)}/T_J$	Reference to 25°C , $I_D = 50\text{ }\mu\text{A}$		11		mV/°C
Static Drain-to-Source On Resistance	$R_{DS(ON)}$	$V_{GS} = 10\text{ V}, I_D = 1.2\text{ A}$		3.7	4.5	Ω
Forward Transconductance	g_{FS}	$V_{DS} = 15\text{ V}, I_D = 1.2\text{ A}$		2.1		S

DYNAMIC CHARACTERISTICS

Input Capacitance (Note 5)	C_{iss}	$V_{DS} = 25\text{ V}, V_{GS} = 0\text{ V}, f = 1\text{ MHz}$		440		pF
Output Capacitance (Note 5)	C_{oss}			52		
Reverse Transfer Capacitance (Note 5)	C_{rss}			9.0		
Total Gate Charge (Note 5)	Q_g	$V_{DS} = 400\text{ V}, I_D = 3.3\text{ A}, V_{GS} = 10\text{ V}$		17		nC
Gate-to-Source Charge (Note 5)	Q_{gs}			3.5		
Gate-to-Drain ("Miller") Charge (Note 5)	Q_{gd}			9.1		
Plateau Voltage	V_{GP}			6.5		
Gate Resistance	R_g			5.5		Ω

RESISTIVE SWITCHING CHARACTERISTICS (Note 6)

Turn-on Delay Time	$t_{d(on)}$	$V_{DD} = 400\text{ V}, I_D = 3.3\text{ A}, V_{GS} = 10\text{ V}, R_G = 0\text{ }\Omega$		9.0		ns
Rise Time	t_r			7.0		
Turn-off Delay Time	$t_{d(off)}$			17		
Fall Time	t_f			9.0		

SOURCE-DRAIN DIODE CHARACTERISTICS

Diode Forward Voltage	V_{SD}	$I_S = 3.0\text{ A}, V_{GS} = 0\text{ V}$	$T_J = 25^\circ\text{C}$		0.9	1.6	V
			$T_J = 100^\circ\text{C}$		0.8		
Reverse Recovery Time	t_{rr}	$V_{GS} = 0\text{ V}, V_{DD} = 30\text{ V}, I_S = 3.3\text{ A}, d_i/d_t = 100\text{ A}/\mu\text{s}$		360		ns	
Charge Time	t_a			81			
Discharge Time	t_b			280			
Reverse Recovery Charge	Q_{rr}			1.3			μC

4. Pulse Width $\leq 380\text{ }\mu\text{s}$, Duty Cycle $\leq 2\%$.
5. Guaranteed by design.
6. Switching characteristics are independent of operating junction temperatures.

TYPICAL CHARACTERISTICS

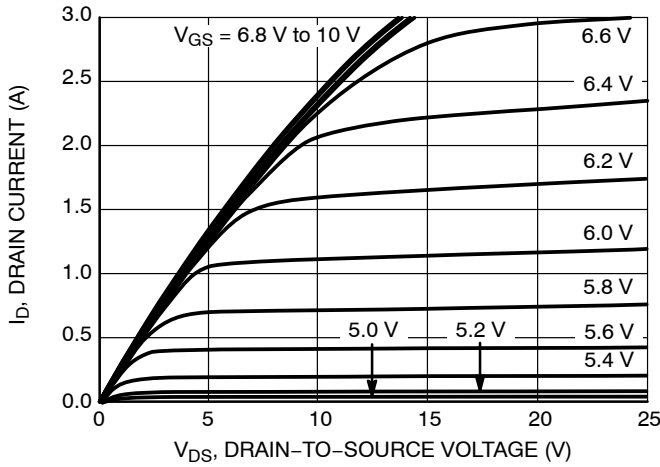

Figure 1. On-Region Characteristics

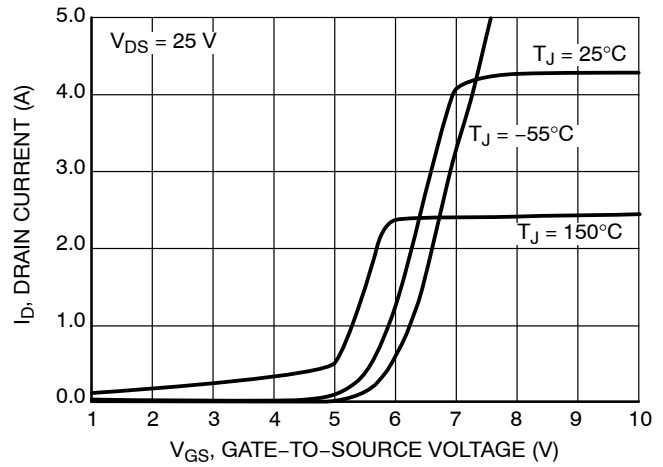

Figure 2. Transfer Characteristics

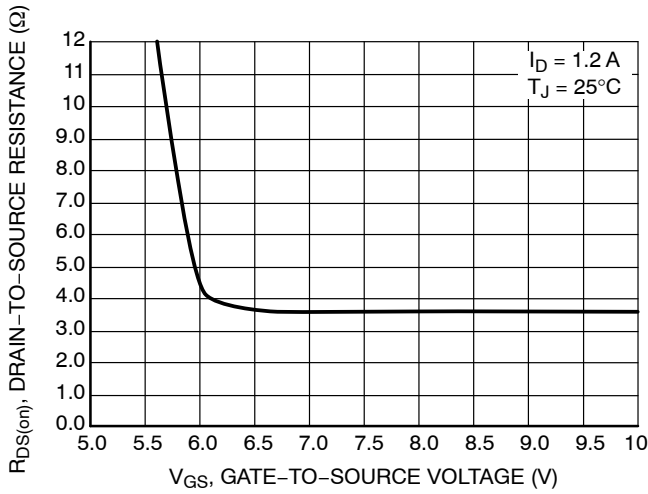

Figure 3. On-Region versus Gate-to-Source Voltage

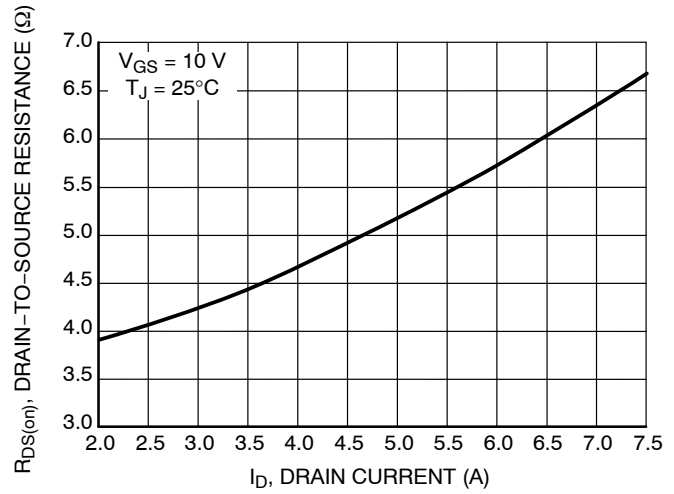

Figure 4. On-Resistance versus Drain Current and Gate Voltage

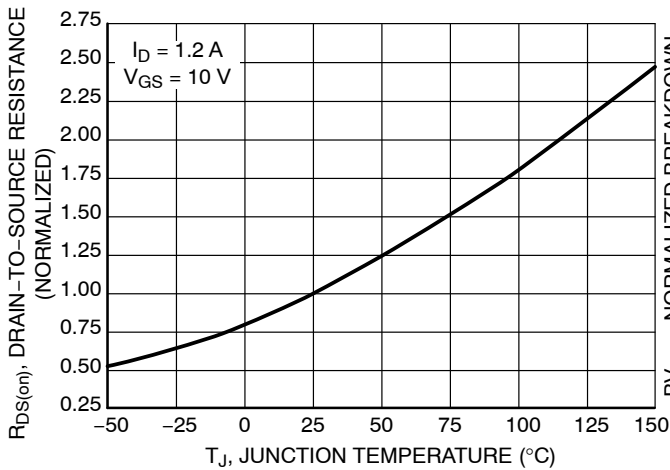

Figure 5. On-Resistance Variation with Temperature

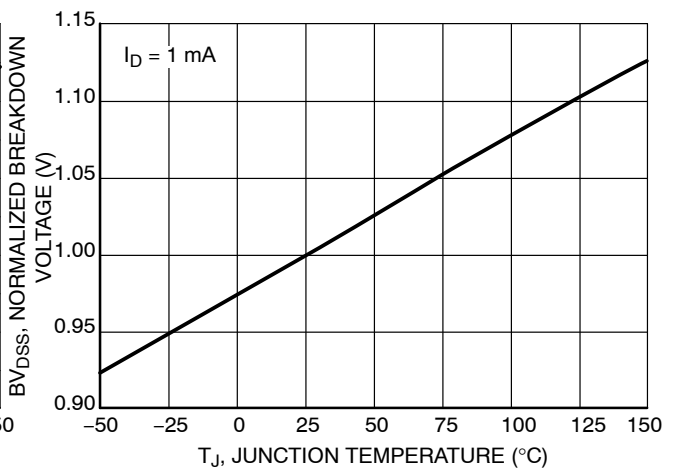

Figure 6. BV_{DSS} Variation with Temperature

TYPICAL CHARACTERISTICS

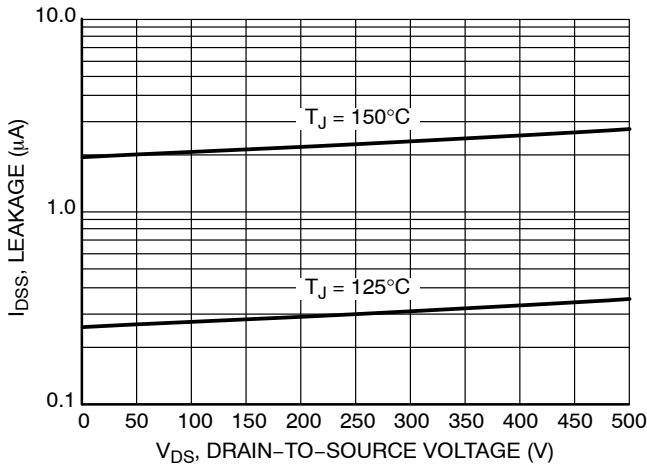

Figure 7. Drain-to-Source Leakage Current versus Voltage

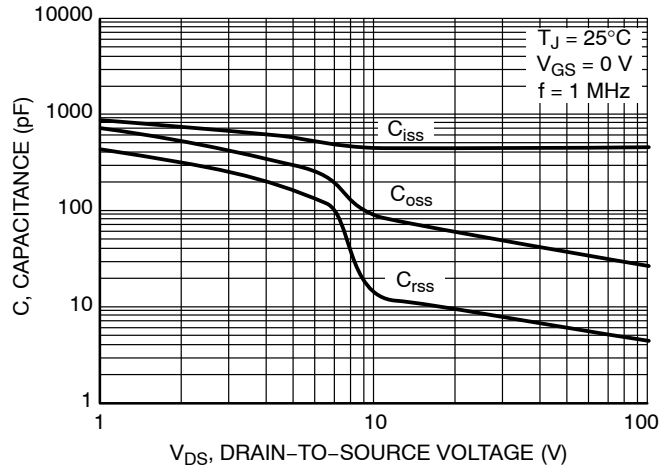

Figure 8. Capacitance Variation

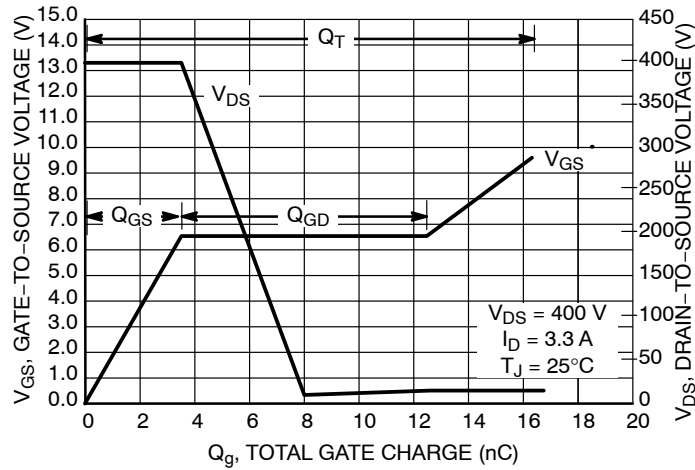

Figure 9. Gate-to-Source Voltage and Drain-to-Source Voltage versus Total Charge

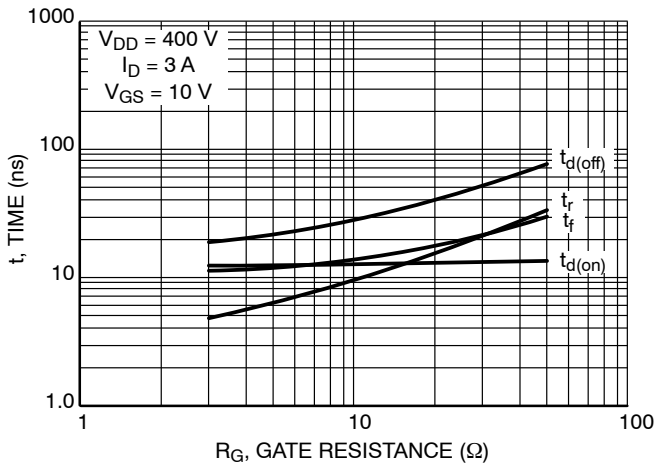

Figure 10. Resistive Switching Time Variation versus Gate Resistance

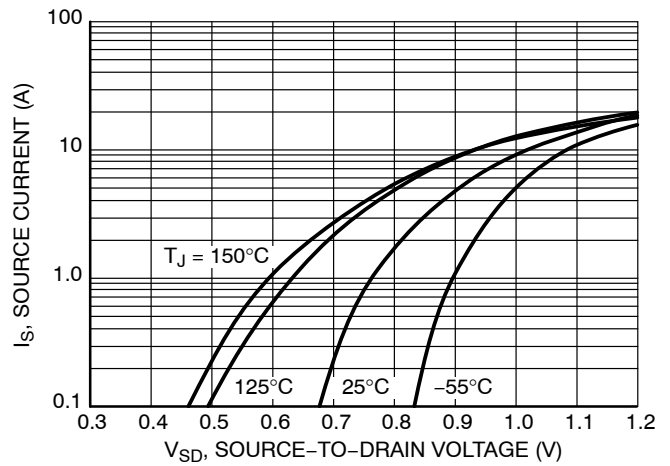

Figure 11. Diode Forward Voltage versus Current

NDD03N80Z

TYPICAL CHARACTERISTICS

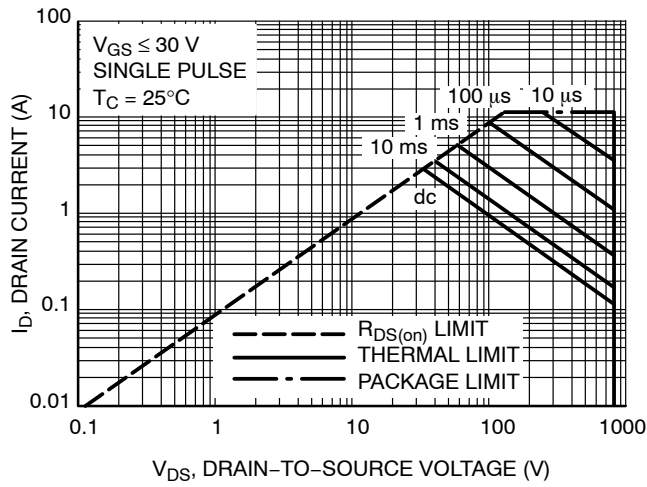

Figure 12. Maximum Rated Forward Biased Safe Operating Area

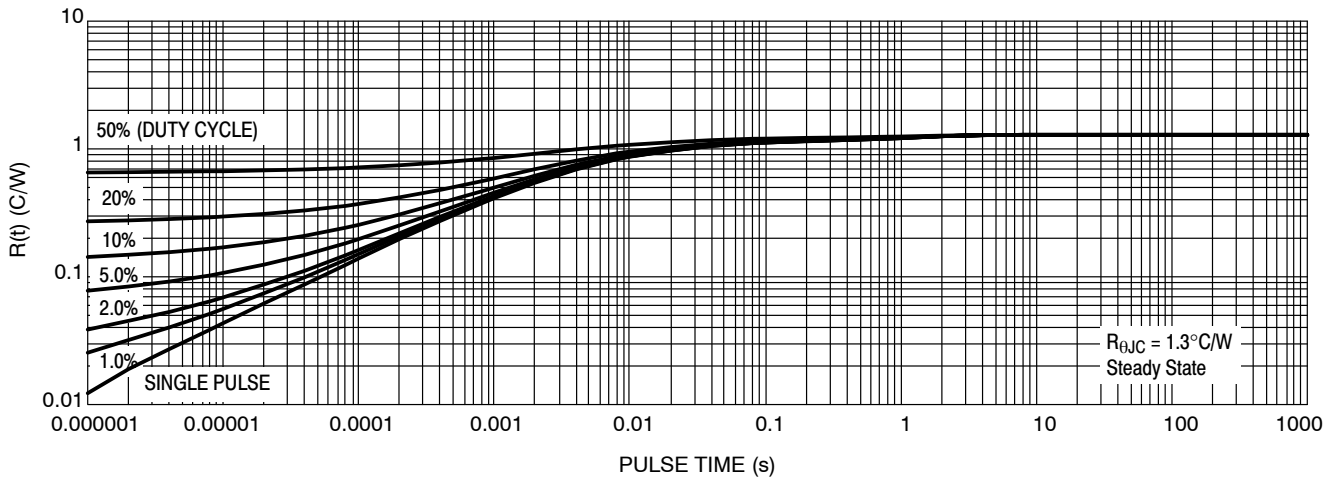

Figure 13. Thermal Impedance (Junction-to-Case)

NDD03N80Z

Table 1. ORDERING INFORMATION

Device	Package	Shipping†
NDD03N80Z-1G	IPAK (Pb-Free, Halogen-Free)	75 Units / Rail
NDD03N80ZT4G	DPAK (Pb-Free, Halogen-Free)	2500 / Tape & Reel

†For information on tape and reel specifications, including part orientation and tape sizes, please refer to our Tape and Reel Packaging Specifications Brochure, BRD8011/D.

MARKING DIAGRAMS

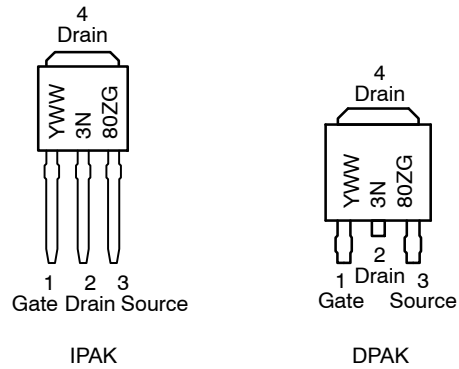

- A = Location Code
- Y = Year
- WW = Work Week
- G, H = Pb-Free, Halogen-Free Package

NDD03N80Z

PACKAGE DIMENSIONS

IPAK CASE 369D ISSUE C

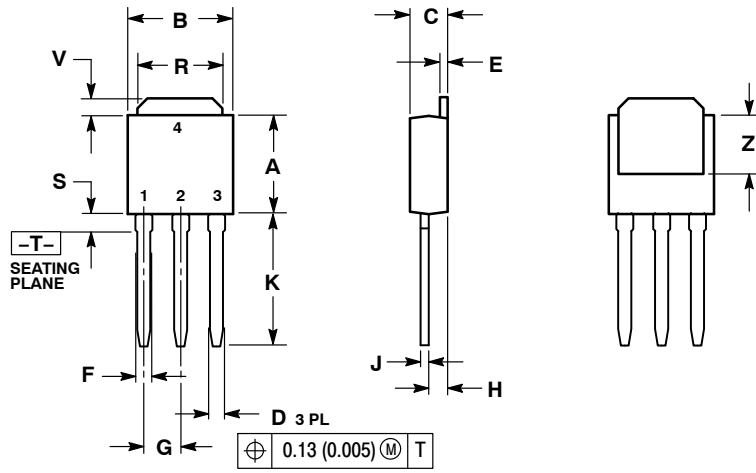

NOTES:

1. DIMENSIONING AND TOLERANCING PER ANSI Y14.5M, 1982.
2. CONTROLLING DIMENSION: INCH.

DIM	INCHES		MILLIMETERS	
	MIN	MAX	MIN	MAX
A	0.235	0.245	5.97	6.35
B	0.250	0.265	6.35	6.73
C	0.086	0.094	2.19	2.38
D	0.027	0.035	0.69	0.88
E	0.018	0.023	0.46	0.58
F	0.037	0.045	0.94	1.14
G	0.090 BSC		2.29 BSC	
H	0.034	0.040	0.87	1.01
J	0.018	0.023	0.46	0.58
K	0.350	0.380	8.89	9.65
R	0.180	0.215	4.45	5.45
S	0.025	0.040	0.63	1.01
V	0.035	0.050	0.89	1.27
Z	0.155	---	3.93	---

NDD03N80Z

PACKAGE DIMENSIONS

DKPAK (SINGLE GAUGE) CASE 369AA ISSUE B

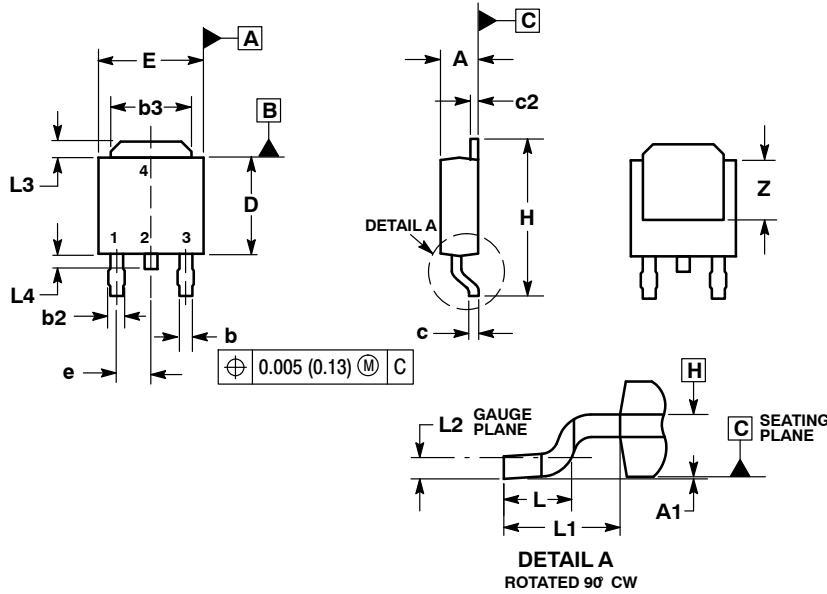

NOTES:

1. DIMENSIONING AND TOLERANCING PER ASME Y14.5M, 1994.
2. CONTROLLING DIMENSION: INCHES.
3. THERMAL PAD CONTOUR OPTIONAL WITHIN DIMENSIONS b3, L3 and Z.
4. DIMENSIONS D AND E DO NOT INCLUDE MOLD FLASH, PROTRUSIONS, OR BURRS. MOLD FLASH, PROTRUSIONS, OR GATE BURRS SHALL NOT EXCEED 0.006 INCHES PER SIDE.
5. DIMENSIONS D AND E ARE DETERMINED AT THE OUTERMOST EXTREMES OF THE PLASTIC BODY.
6. DATUMS A AND B ARE DETERMINED AT DATUM PLANE H.

DIM	INCHES		MILLIMETERS	
	MIN	MAX	MIN	MAX
A	0.086	0.094	2.18	2.38
A1	0.000	0.005	0.00	0.13
b	0.025	0.035	0.63	0.89
b2	0.030	0.045	0.76	1.14
b3	0.180	0.215	4.57	5.46
c	0.018	0.024	0.46	0.61
c2	0.018	0.024	0.46	0.61
D	0.235	0.245	5.97	6.22
E	0.250	0.265	6.35	6.73
e	0.090	BSC	2.29	BSC
H	0.370	0.410	9.40	10.41
L	0.055	0.070	1.40	1.78
L1	0.108	REF	2.74	REF
L2	0.020	BSC	0.51	BSC
L3	0.035	0.050	0.89	1.27
L4	---	0.040	---	1.01
Z	0.155	---	3.93	---

SOLDERING FOOTPRINT*

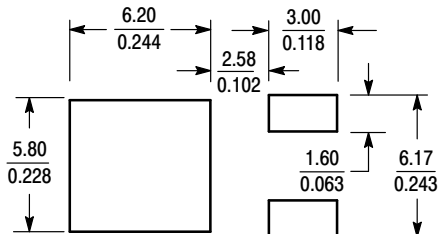

SCALE 3:1 (mm/inches)

*For additional information on our Pb-Free strategy and soldering details, please download the ON Semiconductor Soldering and Mounting Techniques Reference Manual, SOLDERRM/D.

ON Semiconductor and are registered trademarks of Semiconductor Components Industries, LLC (SCILLC). SCILLC owns the rights to a number of patents, trademarks, copyrights, trade secrets, and other intellectual property. A listing of SCILLC's product/patent coverage may be accessed at www.onsemi.com/site/pdf/Patent-Marking.pdf. SCILLC reserves the right to make changes without further notice to any products herein. SCILLC makes no warranty, representation or guarantee regarding the suitability of its products for any particular purpose, nor does SCILLC assume any liability arising out of the application or use of any product or circuit, and specifically disclaims any and all liability, including without limitation special, consequential or incidental damages. "Typical" parameters which may be provided in SCILLC data sheets and/or specifications can and do vary in different applications and actual performance may vary over time. All operating parameters, including "Typicals" must be validated for each customer application by customer's technical experts. SCILLC does not convey any license under its patent rights nor the rights of others. SCILLC products are not designed, intended, or authorized for use as components in systems intended for surgical implant into the body, or other applications intended to support or sustain life, or for any other application in which the failure of the SCILLC product could create a situation where personal injury or death may occur. Should Buyer purchase or use SCILLC products for any such unintended or unauthorized application, Buyer shall indemnify and hold SCILLC and its officers, employees, subsidiaries, affiliates, and distributors harmless against all claims, costs, damages, and expenses, and reasonable attorney fees arising out of, directly or indirectly, any claim of personal injury or death associated with such unintended or unauthorized use, even if such claim alleges that SCILLC was negligent regarding the design or manufacture of the part. SCILLC is an Equal Opportunity/Affirmative Action Employer. This literature is subject to all applicable copyright laws and is not for resale in any manner.

PUBLICATION ORDERING INFORMATION

LITERATURE FULFILLMENT:
Literature Distribution Center for ON Semiconductor
P.O. Box 5163, Denver, Colorado 80217 USA
Phone: 303-675-2175 or 800-344-3860 Toll Free USA/Canada
Fax: 303-675-2176 or 800-344-3867 Toll Free USA/Canada
Email: orderlit@onsemi.com

N. American Technical Support: 800-282-9855 Toll Free
USA/Canada
Europe, Middle East and Africa Technical Support:
Phone: 421 33 790 2910
Japan Customer Focus Center
Phone: 81-3-5817-1050

ON Semiconductor Website: www.onsemi.com
Order Literature: <http://www.onsemi.com/orderlit>

For additional information, please contact your local Sales Representative