

MUR1220CT

Rev.F Mar.-2016

描述 / Descriptions

TO-220 塑封封装 超快恢复二极管。

Ultrafast Recovery Diode in a TO-220 Plastic Package.

特征 / Features

采用硅外延工艺生产的超快恢复二极管，具有较低的反向漏电和高可靠性。

Silicon epitaxial process to produce ultrafast recovery diode with low reverse leakage current and high reliability.

用途 / Applications

用于高频、高压、大电流整流二极管，续流二极管。

For high frequency, high voltage, high current rectifier diode, freewheeling diode.

内部等效电路 / Equivalent Circuit

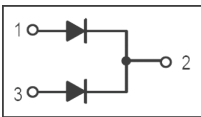

引脚排列 / Pinning

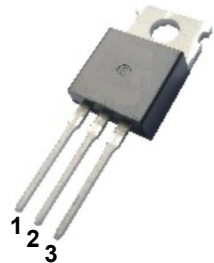

PIN1: Anode

PIN 2: Cathode

PIN 3: Anode

放大及印章代码 / h_{FE} Classifications & Marking

见印章说明。See Marking Instructions

极限参数 / Absolute Maximum Ratings(Ta=25°C)

参数 Parameter	符号 Symbol	数值 Rating	单位 Unit
Peak Repetitive Reverse Voltage	V_{RRM}	200	V
RMS Reverse Voltage	V_{RMS}	140	V
DC Blocking Voltage	V_{DC}	200	V
Average Forward Current	I_F	2×6	A
Non Repetitive Peak Surge Current	I_{FSM}	100	A
Thermal Resistance Junction to Case	$R_{\theta JC}$	2.8	°C/W
Operating and Storage Temperature Range	T_j, T_{stg}	-55~150	°C

电性能参数 / Electrical Characteristics(Ta=25°C)

参数 Parameter	符号 Symbol	测试条件 Test Conditions	最小值 Min	典型值 Typ	最大值 Max	单位 Unit
Forward Voltage	V_F	$I_F=2A$ $T_c=25^\circ C$		0.82		V
		$I_F=2A$ $T_c=125^\circ C$		0.68		V
		$I_F=6A$ $T_c=25^\circ C$		0.92	1.0	V
		$I_F=6A$ $T_c=125^\circ C$		0.82	0.9	V
Instantaneous Reverse Current	I_R (Note 1)	$V_R=200V$ $T_a=25^\circ C$			10	μA
		$V_R=200V$ $T_a=125^\circ C$			150	μA
Reverse Recovery Time	t_{rr}	$I_F=0.5A$ $I_R=1.0A$ $I_{RR}=0.25A$			35	ns

注/Notes:

1. 使用极短的测试时间,以尽量减少自热效应。/Short duration pulse test used to minimize self-heating effect.
2. 除非特别注明,数值为一个芯片的参数。/ Unless otherwise noted, values for the parameters of a single chip

电参数曲线图 / Electrical Characteristic Curve

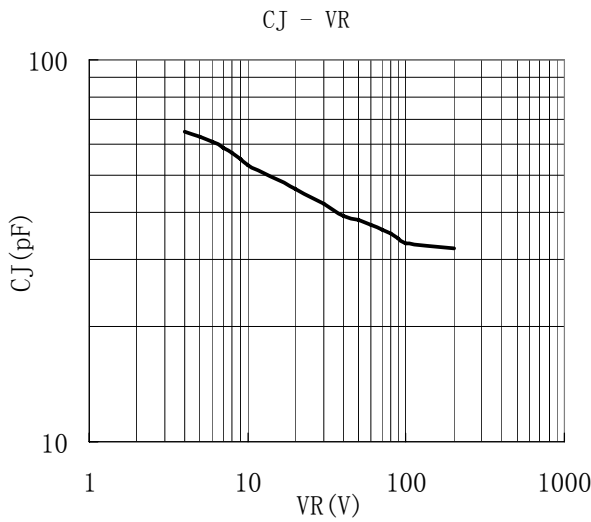
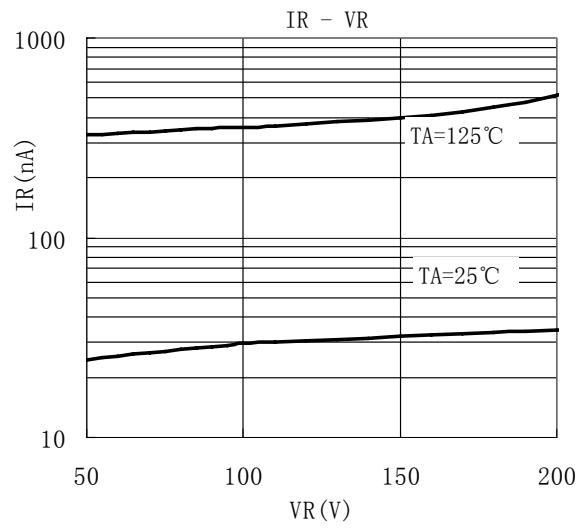
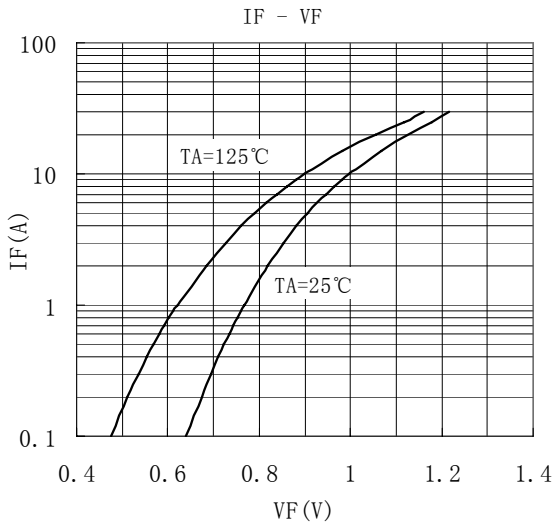
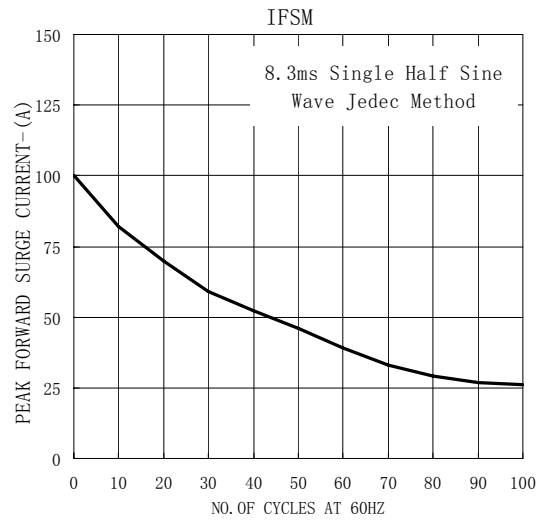
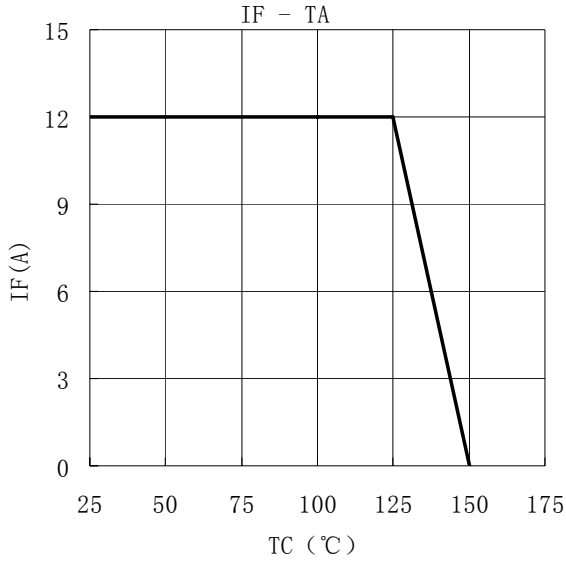

外形尺寸图 / Package Dimensions

TO-220

单位: mm

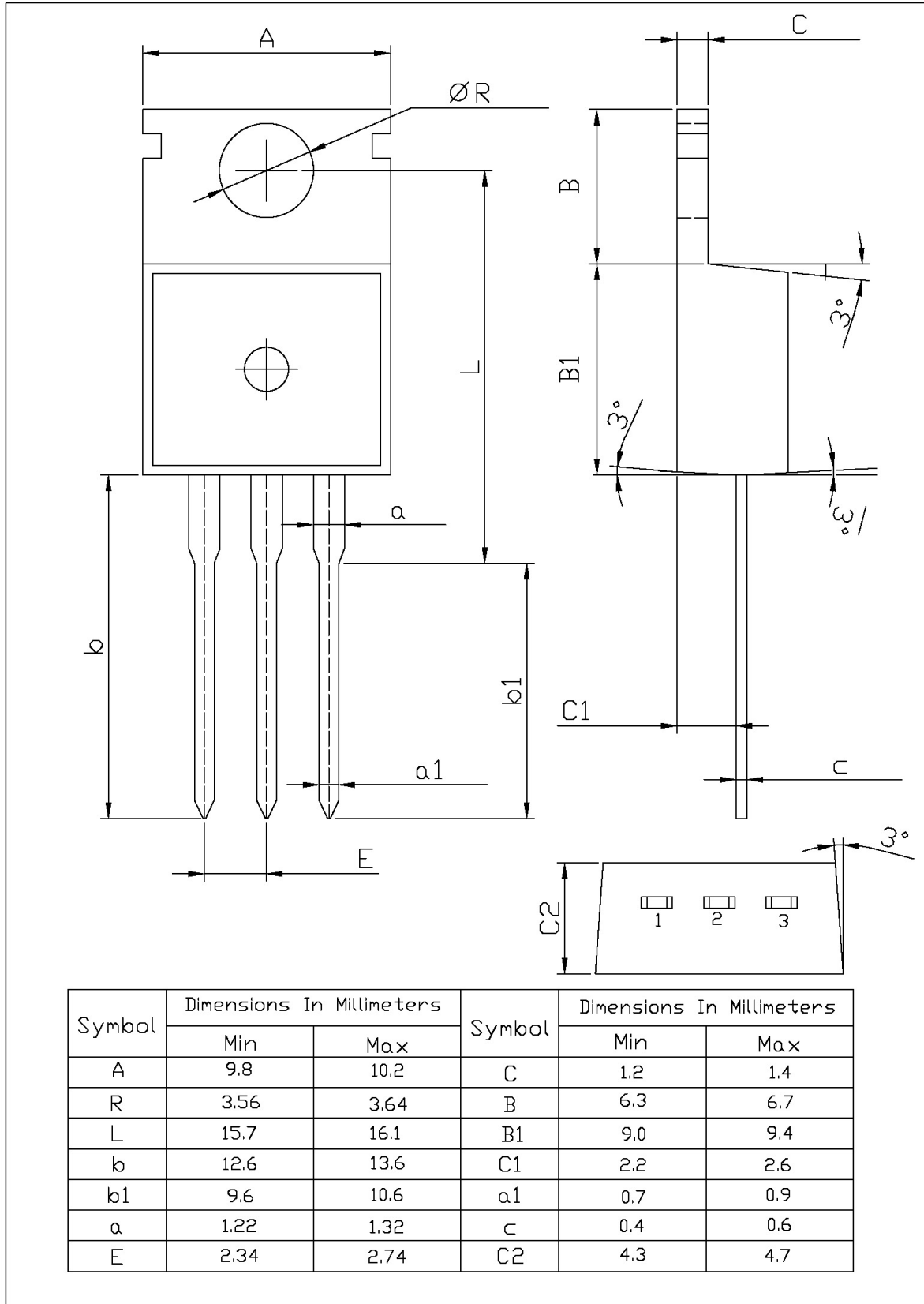

印章说明 / Marking Instructions

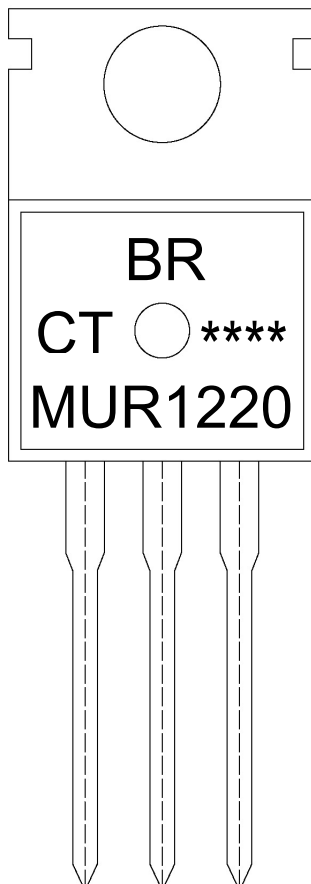

说明：

BR： 为公司代码

MUR1220： 为产品型号

CT： 为内部结构

****： 为生产批号代码，随生产批号变化。

Note:

BR: Company Code

MUR1220 : Product Type.

CT: Internal Structure

****: Lot No. Code, code change with Lot No.

波峰焊温度曲线图(无铅) / Temperature Profile for Dip Soldering(Pb-Free)

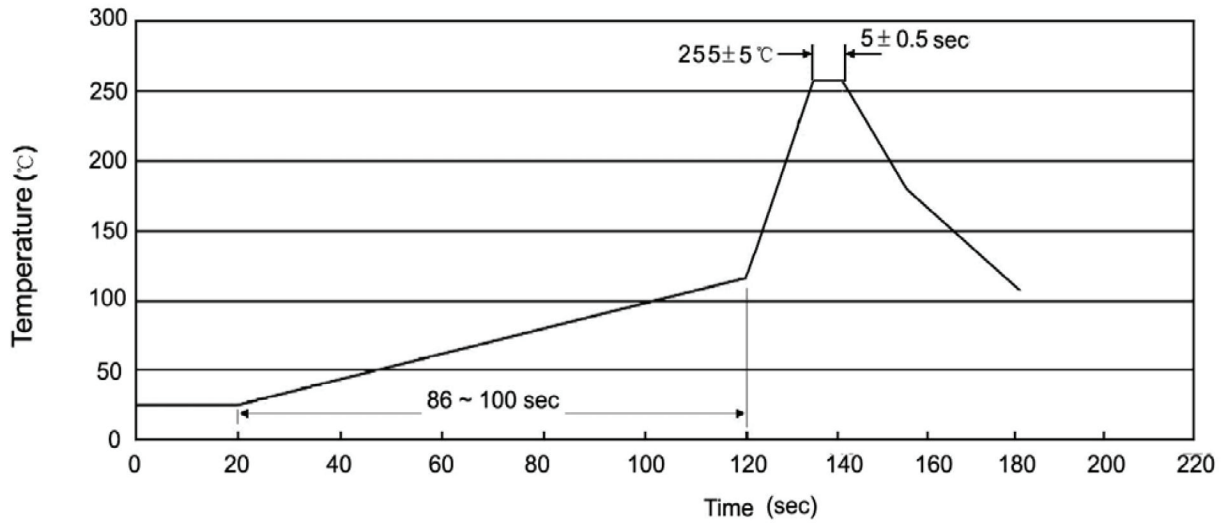

说明：

- 1、预热温度 25 ~ 150°C，时间 60 ~ 90sec；
- 2、峰值温度 255±5°C，时间持续为 5±0.5sec；
- 3、焊接制程冷却速度为 2 ~ 10°C/sec.

Note:

- 1.Preheating:25~150°C, Time:60~90sec.
- 2.Peak Temp.:255±5°C, Duration:5±0.5sec.
3. Cooling Speed: 2~10°C/sec.

耐焊接热试验条件 / Resistance to Soldering Heat Test Conditions

温度：270±5°C

时间：10±1 sec.

Temp.:270±5°C

Time:10±1 sec

包装规格 / Packaging SPEC.

散件包装 / BULK

Package Type 封装形式	Units 包装数量					Dimension 包装尺寸 (unit: mm ³)		
	Units/Bag 只/袋	Bags/Inner Box 袋/盒	Units/Inner Box 只/盒	Inner Boxes/Outer Box 盒/箱	Units/Outer Box 只/箱	Bag 袋	Inner Box 盒	Outer Box 箱
TO-220/F	200	10	2,000	5	10,000	135×190	237×172×102	560×245×195

套管包装 / TUBE

Package Type 封装形式	Units 包装数量					Dimension 包装尺寸 (unit: mm ³)		
	Units/Tube 只/套管	Tubes/Inner Box 套管/盒	Units/Inner Box 只/盒	Inner Boxes/Outer Box 盒/箱	Units/Outer Box 只/箱	Tube 套管	Inner Box 盒	Outer Box 箱
TO-220/F	50	20	1,000	5	5,000	532×31.4×5.5	555×164×50	575×290×180

使用说明 / Notices