

Three Phase Bridge + Thyristor

V_{RRM} / V_{DRM} 800 to 1800V
 I_{FAV} / I_{TAV} 100A

Features

- Blocking voltage:800 to 1800V
- Three Phase Bridge and a Thyristor
- Isolated Module package

Applications

- Inverter for AC or DC motor control
- Current stabilized power supply
- Switching power supply
- UL recognized applied for file no. E360040

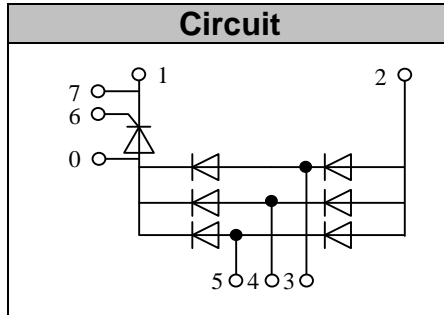

Module Type

TYPE	V_{RRM} / V_{DRM}	V_{RSM}
MT100DT08L1	800V	900V
MT100DT12L1	1200V	1300V
MT100DT16L1	1600V	1700V
MT100DT18L1	1800V	1900V

◆ Diode

Maximum Ratings

Symbol	Item	Conditions	Values	Units
I_D	Output Current(D.C.)	$T_c=100^\circ\text{C}$ Three phase full wave	100	A
I_{FSM}	Surge forward current	$t=10\text{mS}$ $T_{vj}=45^\circ\text{C}$	1200	A
i^2t	Circuit Fusing Consideration		7200	A^2s
Visol	Isolation Breakdown Voltage(R.M.S)	a.c.50HZ;r.m.s.;1min	3000	V
T_{vj}	Operating Junction Temperature		-40 to +150	$^\circ\text{C}$
T_{stg}	Storage Temperature		-40 to +125	$^\circ\text{C}$
M_t	Mounting Torque	To terminals(M5)	$3\pm 15\%$	Nm
M_s		To heatsink(M5)	$3\pm 15\%$	Nm
Weight		Module (Approximately)	210	g

Thermal Characteristics

Symbol	Item	Conditions	Values	Units
$R_{th(j-c)}$	Thermal Impedance, max.	Junction to Case(TOTAL)	0.18	$^\circ\text{C/W}$
$R_{th(c-s)}$	Thermal Impedance, max.	Case to Heatsink	0.10	$^\circ\text{C/W}$

Electrical Characteristics

Symbol	Item	Conditions	Values	Units
VFM	Forward Voltage Drop, max.	$T=25^\circ\text{C}$ $I_F=100\text{A}$	1.35	V
I_{RRM}	Repetitive Peak Reverse Current, max.	$T_{vj}=25^\circ\text{C}$ $V_{RD}=V_{RRM}$ $T_{vj}=150^\circ\text{C}$ $V_{RD}=V_{RRM}$	≤ 0.5 ≤ 6	mA mA



◆ **Thyristor**

Maximum Ratings

Symbol	Item	Conditions	Values	Units
I_{TAV}	Average On-State Current	$T_c=92^{\circ}C$, Single Phase half wave 180° conduction	100	A
I_{TSM}	Surge On-State Current	$T_{VJ}=45^{\circ}C$ t=10ms (50Hz), sine $V_R=0$	1200	A
i^2t	Circuit Fusing Consideration		7200	A ² s
Visol	Isolation Breakdown Voltage(R.M.S)	a.c.50Hz;r.m.s.;1 min	3000	V
T_{vj}	Operating Junction Temperature		-40 to +125	°C
T_{stg}	Storage Temperature		-40 to +125	°C
M_t	Mounting Torque	To terminals(M5)	3±15%	Nm
M_s		To heatsink(M5)	3±15%	Nm
di/dt	Critical Rate of Rise of On-State Current	$T_{VJ}=T_{VJM}$, $V_D=1/2V_{DRM}$, $I_G=100mA$ $d_i/d_t=0.1A/\mu s$	150	A/μs
dv/dt	Critical Rate of Rise of Off-State Voltage, min.	$T_J=T_{VJM}$, $V_D=2/3V_{DRM}$, linear voltage rise	500	V/μs

Electrical and Thermal Characteristics

Symbol	Item	Conditions	Values			Units
			Min.	Typ.	Max.	
V_{TM}	Peak On-State Voltage, max.	$T=25^{\circ}C$ $I_T=100A$			1.25	V
I_{RRM}/I_{DRM}	Repetitive Peak Reverse Current, max. / Repetitive Peak Off-State Current, max.	$T_{VJ}=T_{VJM}$, $V_R=V_{RRM}$, $V_D=V_{DRM}$			20	mA
V_{GT}	Gate Trigger Voltage, max.	$T_{VJ}=25^{\circ}C$, $V_D=6V$		1	3	V
I_{GT}	Gate Trigger Current, typ /max.	$T_{VJ}=25^{\circ}C$, $V_D=6V$		65	150	mA
I_H	Hoding Current, typ / max.	$T_{VJ}=25^{\circ}C$, $V_D=6V$		120	220	mA
I_L	latching Current, typ / max.	$T_{VJ}=25^{\circ}C$, $R=33\Omega$		180	400	mA
Rth(j-c)	Thermal Impedance, max.	Junction to Case			0.26	°C/W
Rth(c-s)	Thermal Impedance, max.	Case to Heatsink			0.10	°C/W



Performance Curves

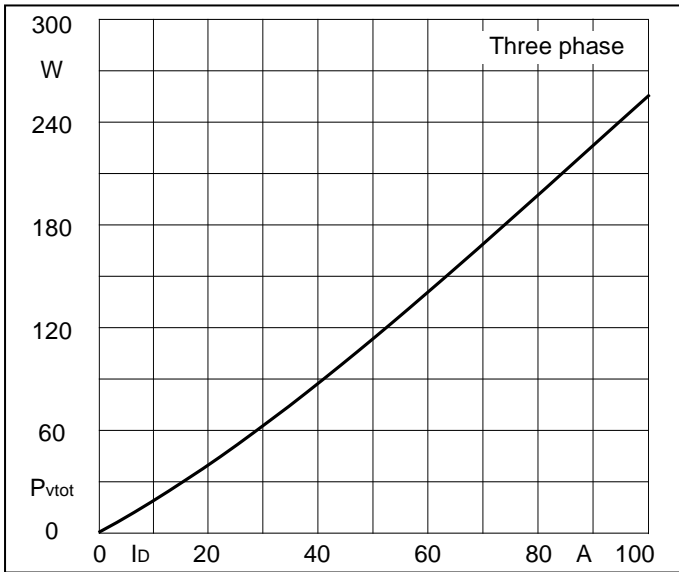

Fig1. Power dissipation

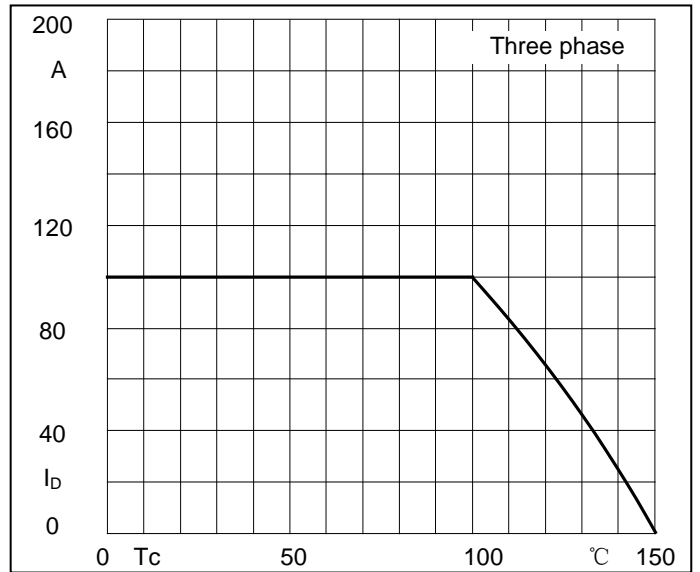

Fig2. Forward Current Derating Curve

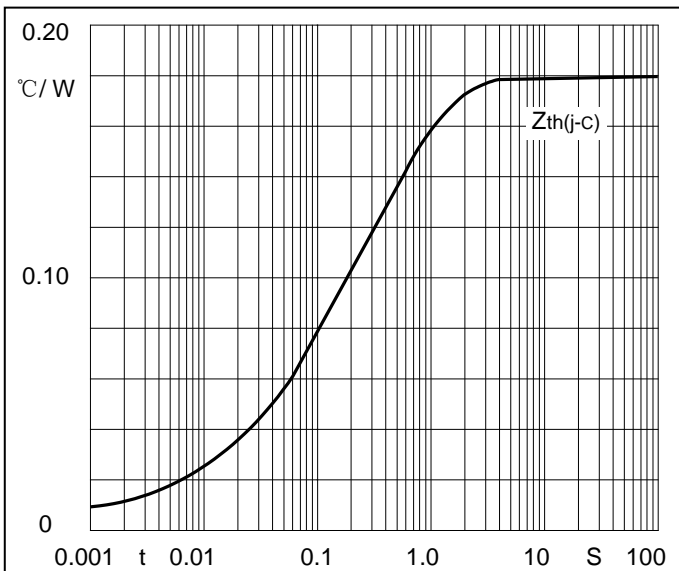

Fig3. Transient thermal impedance

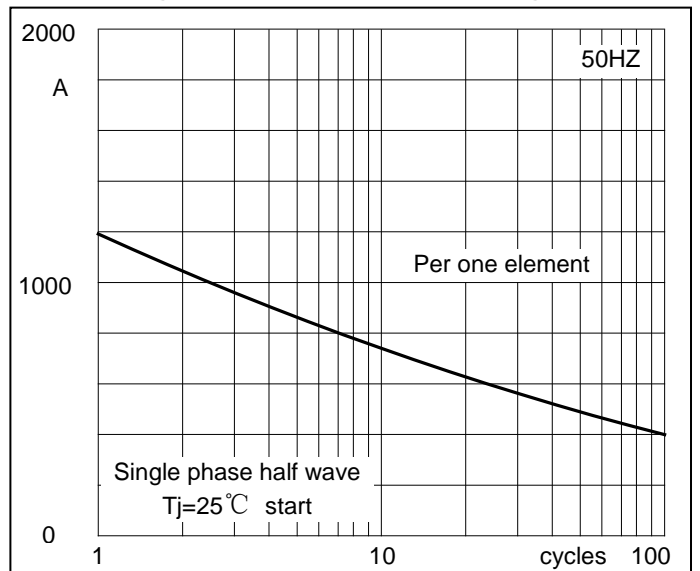

Fig4. Max Non-Repetitive Forward Surge Current

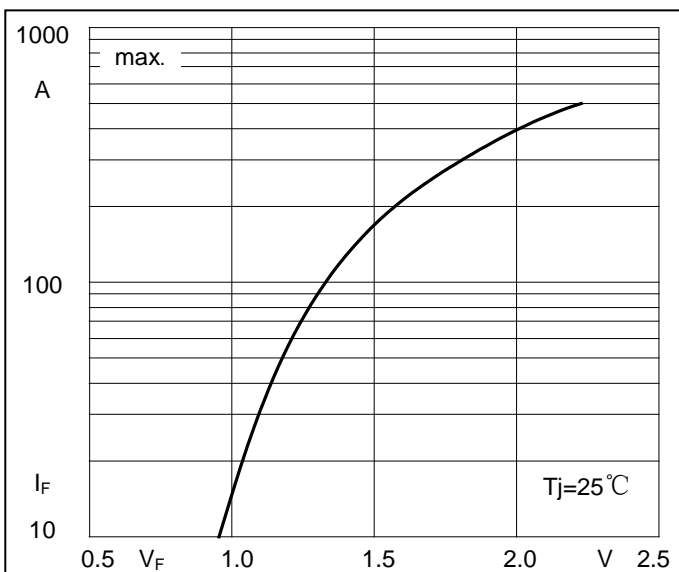

Fig5. Forward Characteristics

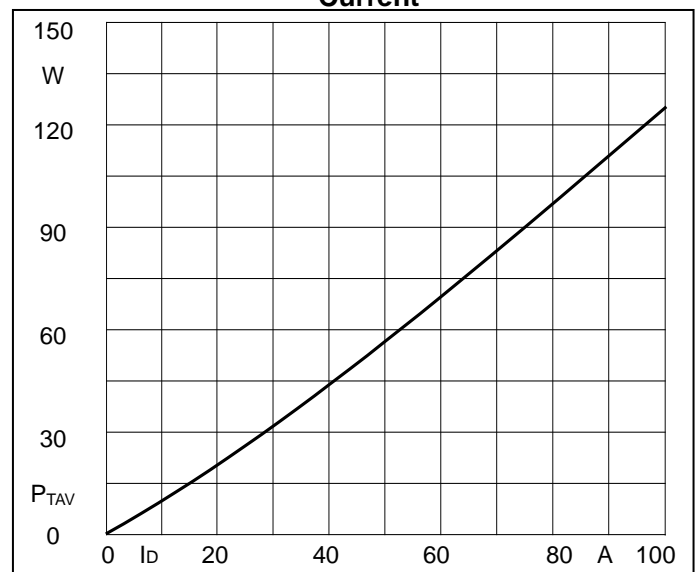

Fig6. SCR Power dissipation

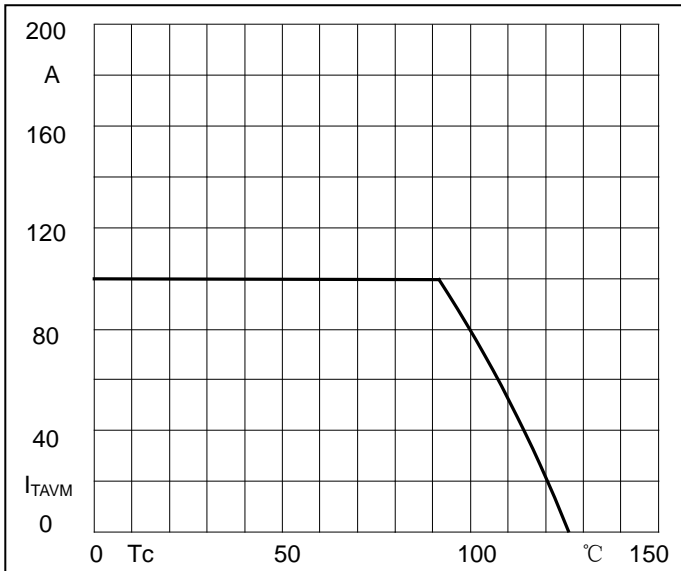

Fig7. SCR Forward Current Derating Curve

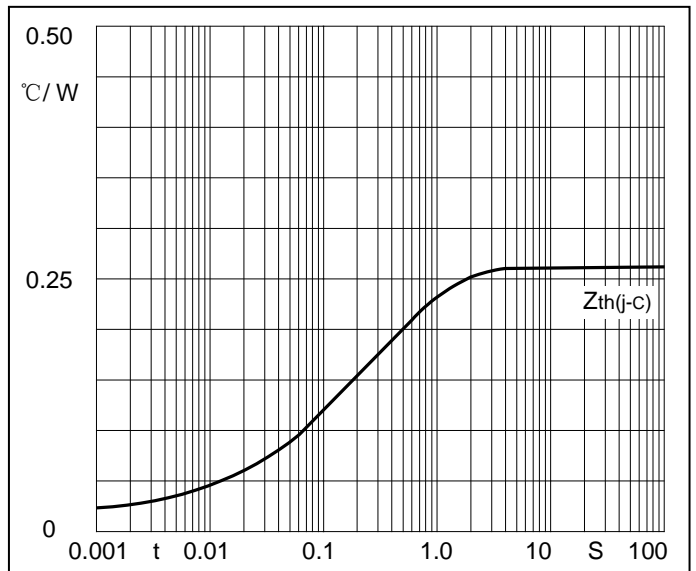

Fig8. SCR Transient thermal impedance

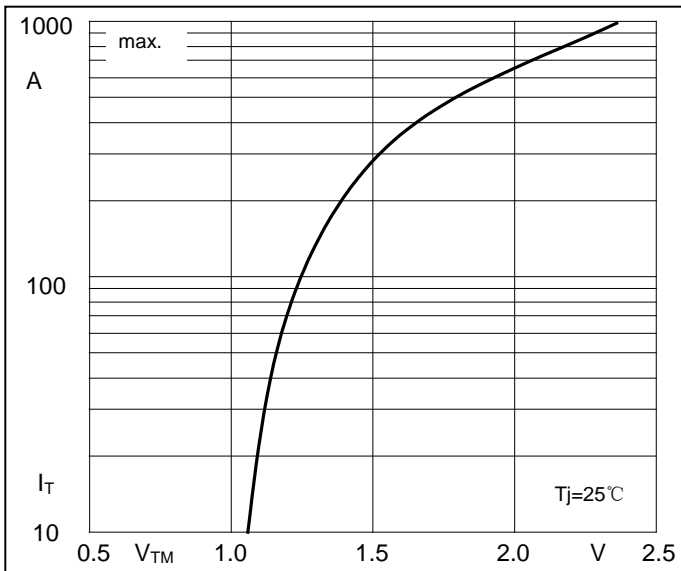

Fig9. SCR Forward Characteristics

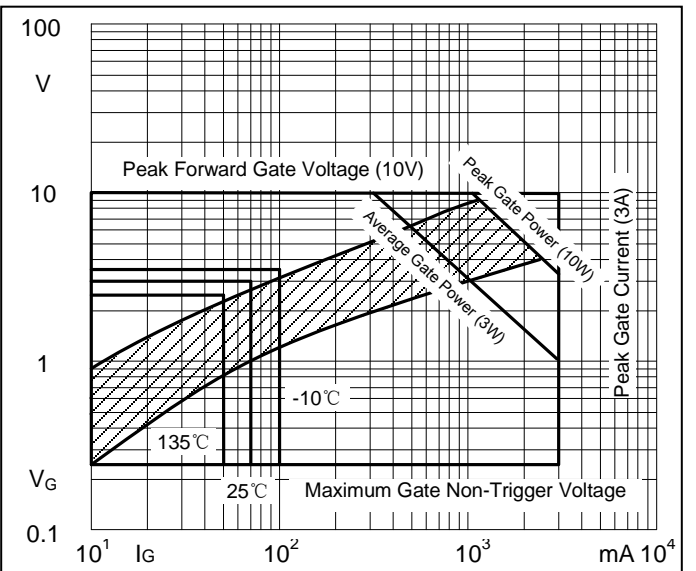

Fig10. Gate trigger Characteristics



Package Outline Information

