

## IRS2103(S)PbF

### HALF-BRIDGE DRIVER

#### Features

- Floating channel designed for bootstrap operation
- Fully operational to +600 V
- Tolerant to negative transient voltage, dV/dt immune
- Gate drive supply range from 10 V to 20 V
- Undervoltage lockout
- 3.3 V, 5 V, and 15 V logic compatible
- Cross-conduction prevention logic
- Matched propagation delay for both channels
- Internal set deadtime
- High-side output in phase with HIN input
- Low-side output out of phase with LIN input
- RoHS compliant

#### Description

The IRS2103 is a high voltage, high speed power MOSFET and IGBT drivers with dependent high- and low-side referenced output channels. Proprietary HVIC and latch immune CMOS technologies enable ruggedized monolithic construction. The logic input is compatible with standard CMOS or LSTTL output, down to 3.3 V logic. The output drivers feature a high pulse current buffer stage designed for minimum driver cross-conduction. The floating channel can be used to drive an N-channel power MOSFET or IGBT in the high-side configuration which operates up to 600 V.

#### Product Summary

$V_{\text{OFFSET}}$	600 V max.
$I_{\text{O}+/-}$	130 mA/270 mA
$V_{\text{OUT}}$	10 V - 20 V
$t_{\text{on/off}}$ (typ.)	680 ns/150 ns
Deadtime (typ.)	520 ns

#### Packages

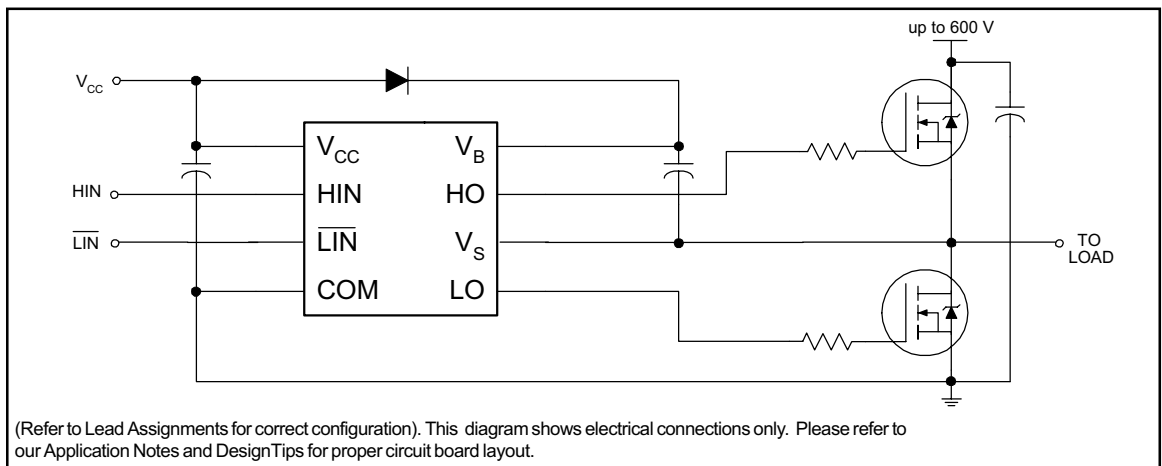


8-Lead PDIP  
IRS2103



8-Lead SOIC  
IRS2103S

#### Typical Connection



## Absolute Maximum Ratings

Absolute maximum ratings indicate sustained limits beyond which damage to the device may occur. All voltage parameters are absolute voltages referenced to COM. The thermal resistance and power dissipation ratings are measured under board mounted and still air conditions.

Symbol	Definition	Min.	Max.	Units	
$V_B$	High-side floating absolute voltage	-0.3	625	V	
$V_S$	High-side floating supply offset voltage	$V_B - 25$	$V_B + 0.3$		
$V_{HO}$	High-side floating output voltage	$V_S - 0.3$	$V_B + 0.3$		
$V_{CC}$	Low-side and logic fixed supply voltage	-0.3	25		
$V_{LO}$	Low-side output voltage	-0.3	$V_{CC} + 0.3$		
$V_{IN}$	Logic input voltage ( $HIN$ & $LIN$ )	-0.3	$V_{CC} + 0.3$		
$dV_S/dt$	Allowable offset supply voltage transient	—	50	V/ns	
$P_D$	Package power dissipation @ $T_A \leq +25$ °C	(8 Lead PDIP)	—	1.0	W
		(8 Lead SOIC)	—	0.625	
$R_{thJA}$	Thermal resistance, junction to ambient	(8 Lead PDIP)	—	125	°C/W
		(8 Lead SOIC)	—	200	
$T_J$	Junction temperature	—	150	°C	
$T_S$	Storage temperature	-55	150		
$T_L$	Lead temperature (soldering, 10 seconds)	—	300		

## Recommended Operating Conditions

The input/output logic timing diagram is shown in Fig. 1. For proper operation the device should be used within the recommended conditions. The  $V_S$  offset rating is tested with all supplies biased at a 15 V differential.

Symbol	Definition	Min.	Max.	Units
$V_B$	High-side floating supply absolute voltage	$V_S + 10$	$V_S + 20$	V
$V_S$	High-side floating supply offset voltage	Note 1	600	
$V_{HO}$	High-side floating output voltage	$V_S$	$V_B$	
$V_{CC}$	Low-side and logic fixed supply voltage	10	20	
$V_{LO}$	Low-side output voltage	0	$V_{CC}$	
$V_{IN}$	Logic input voltage ( $HIN$ & $LIN$ )	0	$V_{CC}$	
$T_A$	Ambient temperature	-40	125	°C

Note 1: Logic operational for  $V_S$  of -5 V to +600 V. Logic state held for  $V_S$  of -5 V to  $-V_B$ . (Please refer to the Design Tip DT97-3 for more details).

## Dynamic Electrical Characteristics

$V_{BIAS}$  ( $V_{CC}$ ,  $V_{BS}$ ) = 15 V,  $C_L$  = 1000 pF and  $T_A$  = 25 °C unless otherwise specified.

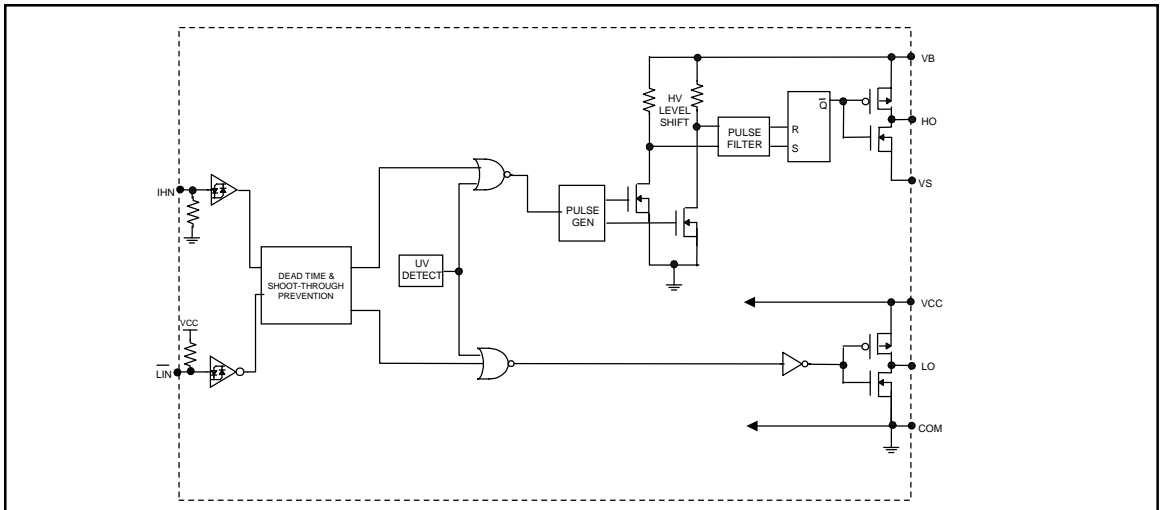
Symbol	Definition	Min.	Typ.	Max.	Units	Test Conditions
$t_{on}$	Turn-on propagation delay	—	680	820	ns	$V_S = 0$ V
$t_{off}$	Turn-off propagation delay	—	150	220		$V_S = 600$ V
$t_r$	Turn-on rise time	—	70	170		
$t_f$	Turn-off fall time	—	35	90		
DT	Deadtime, LS turn-off to HS turn-on & HS turn-on to LS turn-off	400	520	650		
MT	Delay matching, HS & LS turn-on/off	—	—	60		

## Static Electrical Characteristics

$V_{BIAS}$  ( $V_{CC}$ ,  $V_{BS}$ ) = 15 V and  $T_A$  = 25 °C unless otherwise specified. The  $V_{IN}$ ,  $V_{TH}$ , and  $I_{IN}$  parameters are referenced to COM. The  $V_O$  and  $I_O$  parameters are referenced to COM and are applicable to the respective output leads: HO or LO.

Symbol	Definition	Min.	Typ.	Max.	Units	Test Conditions
$V_{IH}$	Logic "1" (HIN) & Logic "0" ( $\overline{LIN}$ ) input voltage	2.5	—	—	V	$V_{CC} = 10$ V to 20 V
$V_{IL}$	Logic "0" (HIN) & Logic "1" ( $\overline{LIN}$ ) input voltage	—	—	0.8		
$V_{OH}$	High level output voltage, $V_{BIAS} - V_O$	—	0.05	0.2		$I_O = 2$ mA
$V_{OL}$	Low level output voltage, $V_O$	—	0.02	0.1		
$I_{LK}$	Offset supply leakage current	—	—	50	$\mu$ A	$V_B = V_S = 600$ V
$I_{QBS}$	Quiescent $V_{BS}$ supply current	—	30	55		$V_{IN} = 0$ V or 5 V
$I_{QCC}$	Quiescent $V_{CC}$ supply current	—	150	270		
$I_{IN+}$	Logic "1" input bias current	—	3	10		HIN = 0 V, $\overline{LIN} = 5$ V
$I_{IN-}$	Logic "0" input bias current	—	—	5		
$V_{CCUV+}$	$V_{CC}$ supply undervoltage positive going threshold	8	8.9	9.8	V	
$V_{CCUV-}$	$V_{CC}$ supply undervoltage negative going threshold	7.4	8.2	9		
$I_{O+}$	Output high short circuit pulsed current	130	290	—	mA	$V_O = 0$ V, $V_{IN} = V_{IH}$ $PW \leq 10$ $\mu$ s
$I_{O-}$	Output low short circuit pulsed current	270	600	—		$V_O = 15$ V, $V_{IN} = V_{IL}$ $PW \leq 10$ $\mu$ s

## Functional Block Diagram

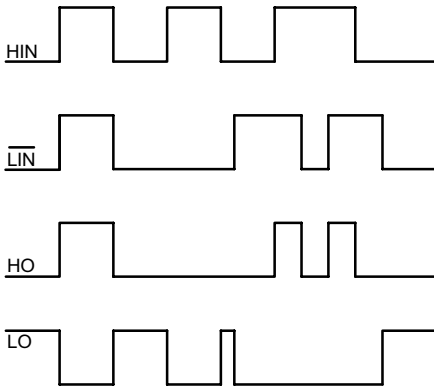


## Lead Definitions

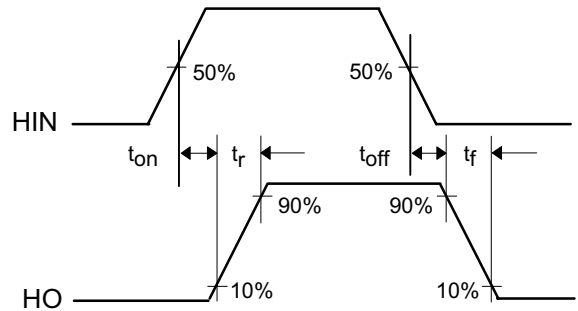
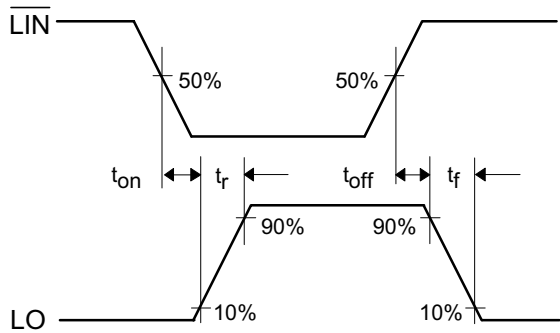
Symbol	Description
HIN	Logic input for high-side gate driver output (HO), in phase
$\overline{\text{LIN}}$	Logic input for low-side gate driver output (LO), out of phase
VB	High-side floating supply
HO	High-side gate drive output
VS	High-side floating supply return
VCC	Low-side and logic fixed supply
LO	Low-side gate drive output
COM	Low-side return

## Lead Assignments

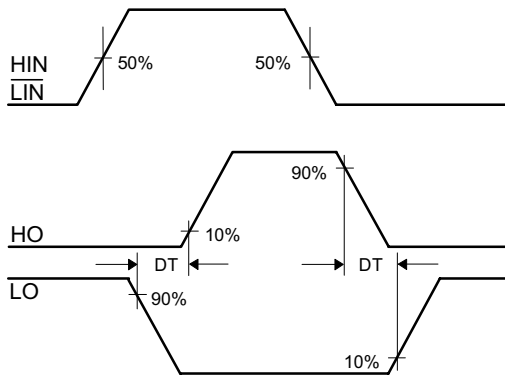
<p>8 Lead PDIP</p>	<p>8 Lead SOIC</p>
<b>IRS2103PbF</b>	<b>IRS2103SPbF</b>



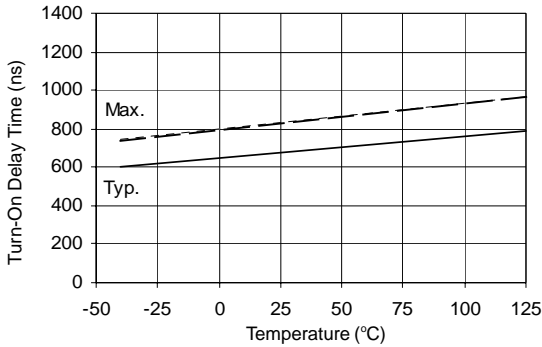
**Figure 1. Input/Output Timing Diagram**



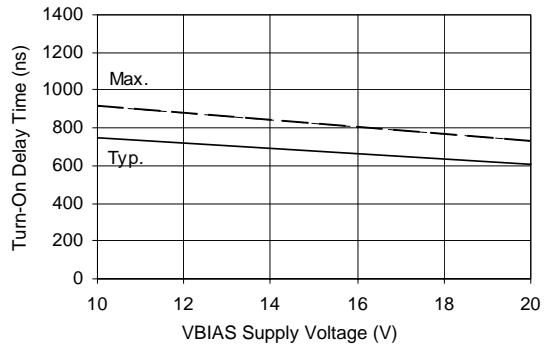
**Figure 2. Switching Time Waveform Definitions**



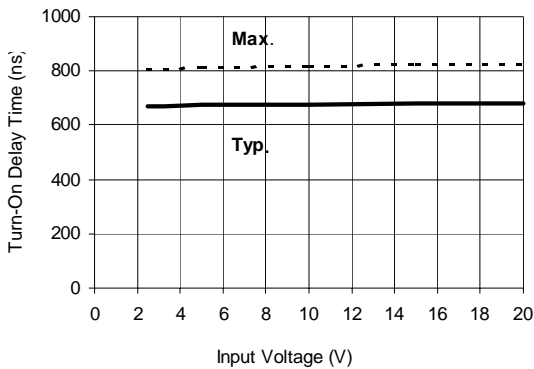
**Figure 3. Deadtime Waveform Definitions**



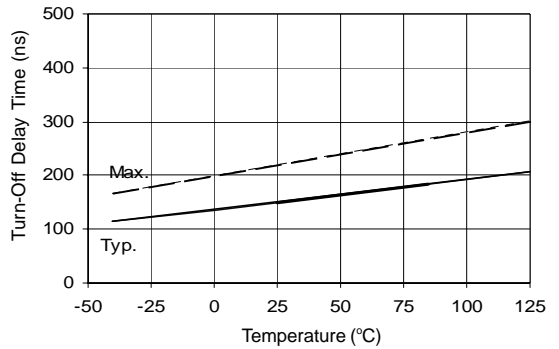
**Figure 4A. Turn-On Time vs. Temperature**



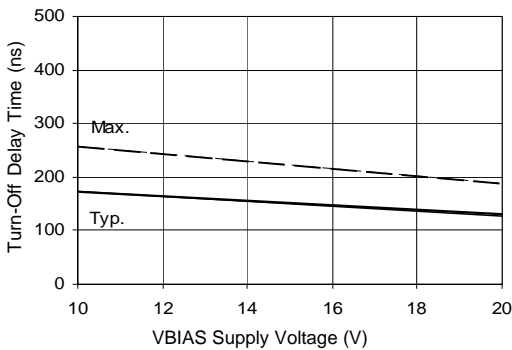
**Figure 4B. Turn-On Time vs. Supply Voltage**



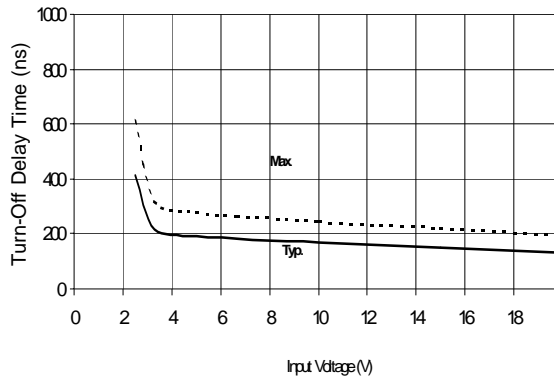
**Figure 4C. Turn-On Time vs. Input Voltage**



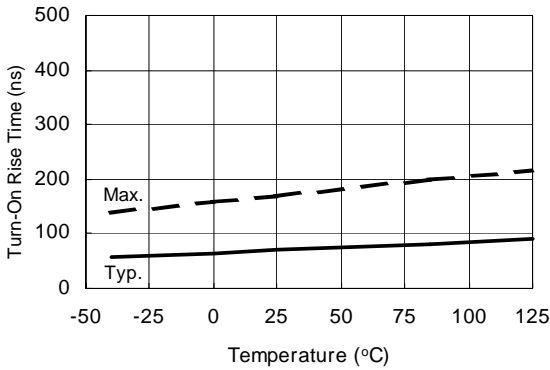
**Figure 5A. Turn-Off Time vs. Temperature**



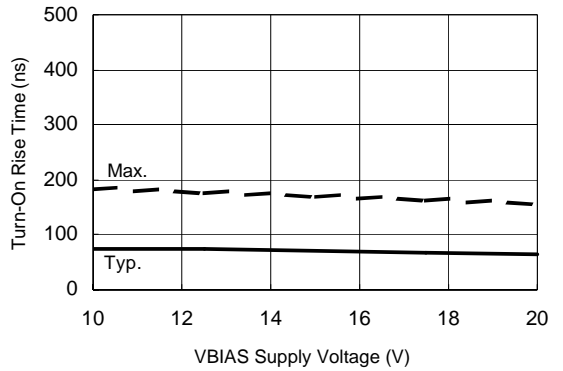
**Figure 5B. Turn-Off Time vs. Supply Voltage**



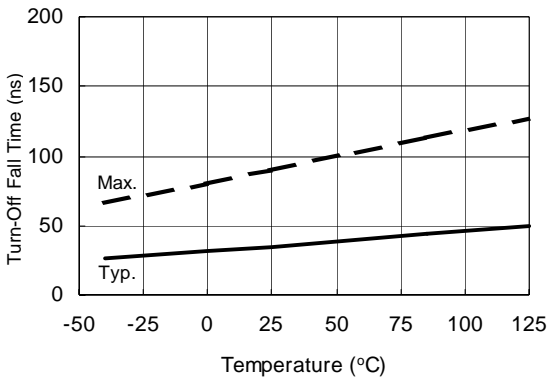
**Figure 5C. Turn-Off Time vs. Input Voltage**



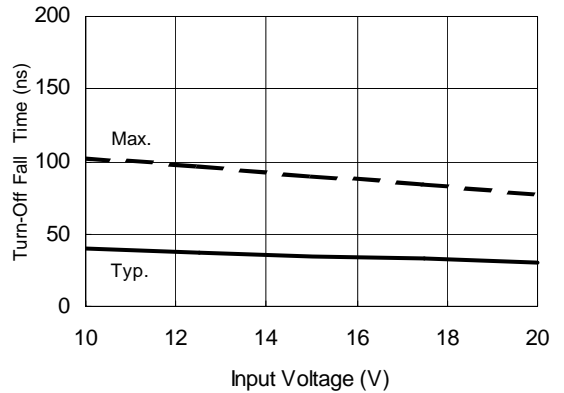
**Figure 6A. Turn-On Rise Time vs. Temperature**



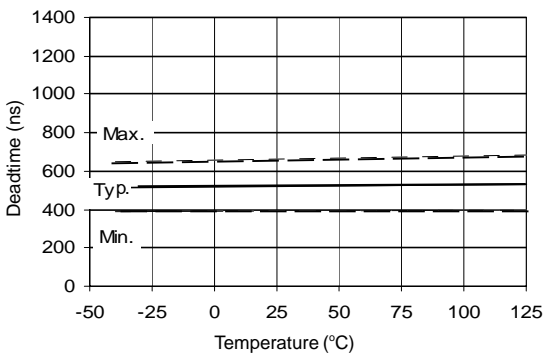
**Figure 6B. Turn-On Rise Time vs. Voltage**



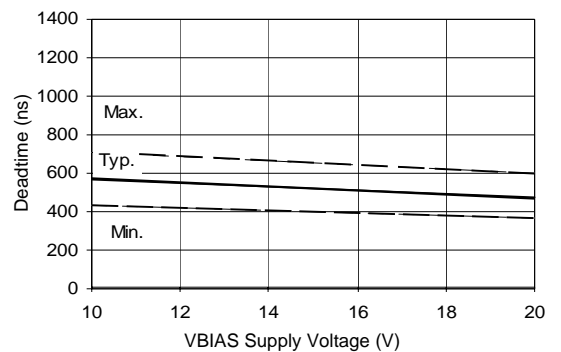
**Figure 7A. Turn-Off Fall Time vs. Temperature**



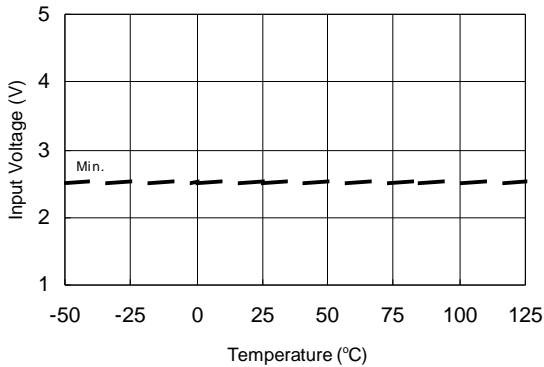
**Figure 7B. Turn-Off Fall Time vs. Voltage**



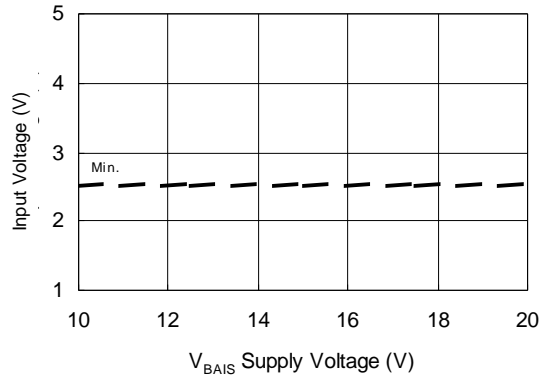
**Figure 8A. Deadtime vs. Temperature**



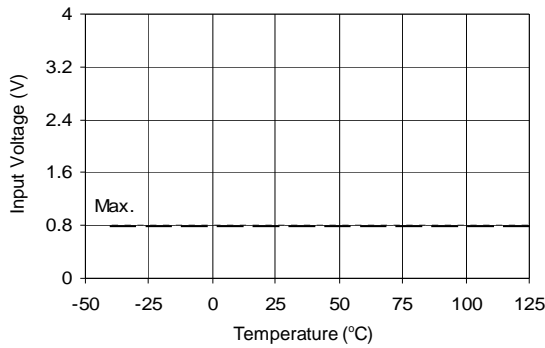
**Figure 8B. Deadtime vs. Voltage**



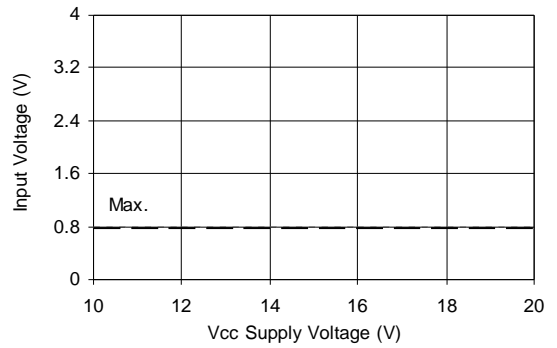
**Figure 9A. Logic "1" Input Voltage vs. Temperature**



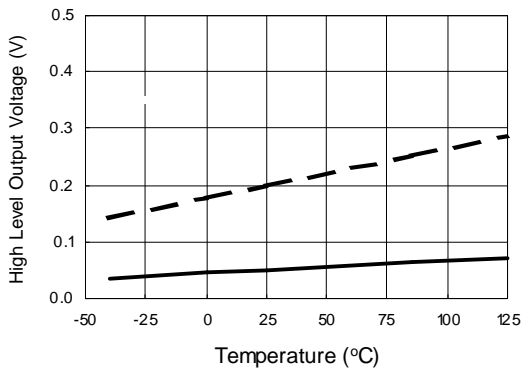
**Figure 9B. Logic "1" Input Voltage vs. Supply Voltage**



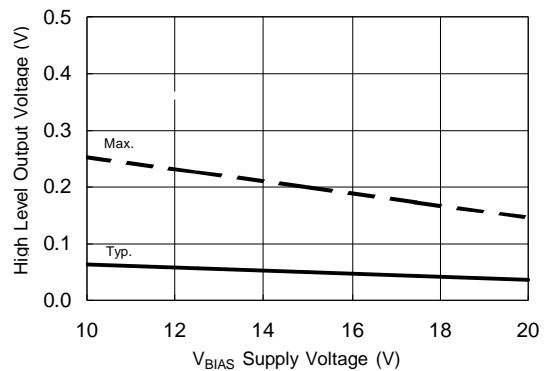
**Figure 10A. Logic "0" (HIN) & Logic "1" (LIN) Input Voltage vs. Temperature**



**Figure 10B. Logic "0" (HIN) & Logic "1" (LIN) Input Voltage vs. Voltage**

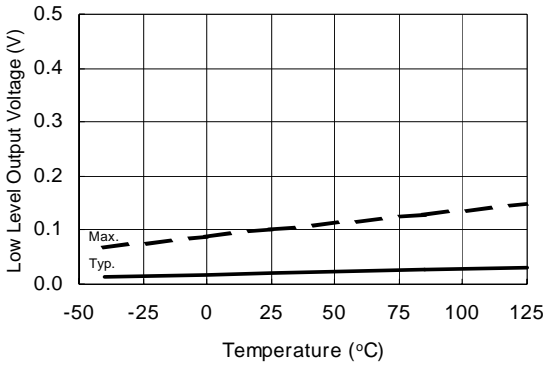


**Figure 11A. High Level Output Voltage vs. Temperature**

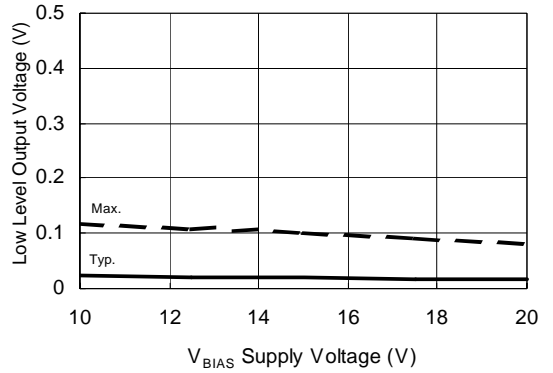


**Figure 11B. High Level Output Voltage vs. Supply Voltage**

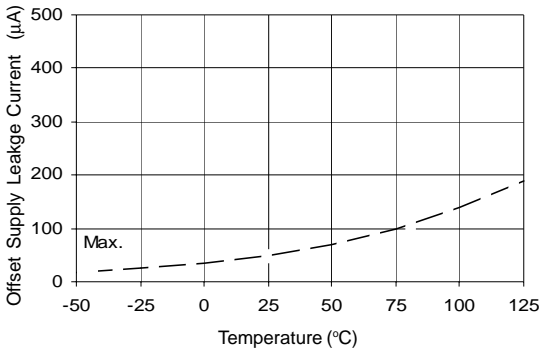




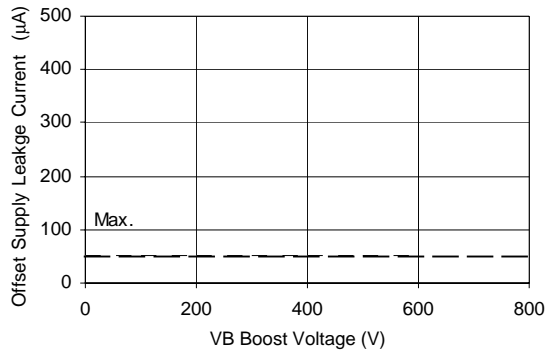
**Figure 12A. Low Level Output Voltage vs. Temperature**



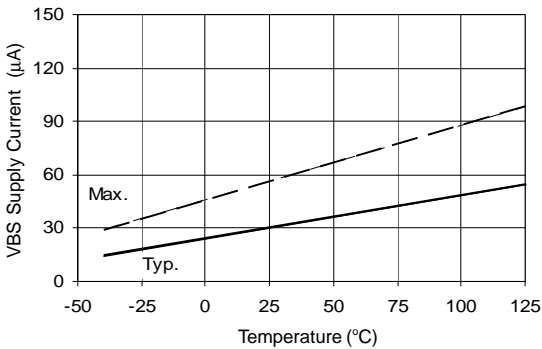
**Figure 12B. Low Level Output Voltage vs. Supply Voltage**



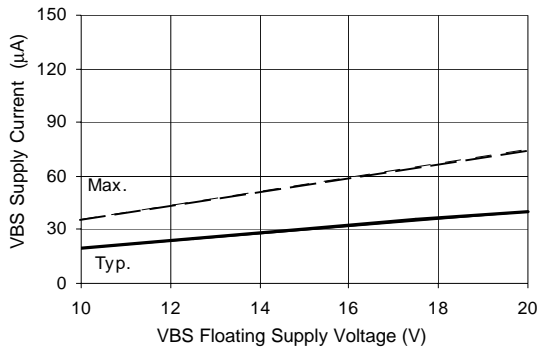
**Figure 13A. Offset Supply Current vs. Temperature**



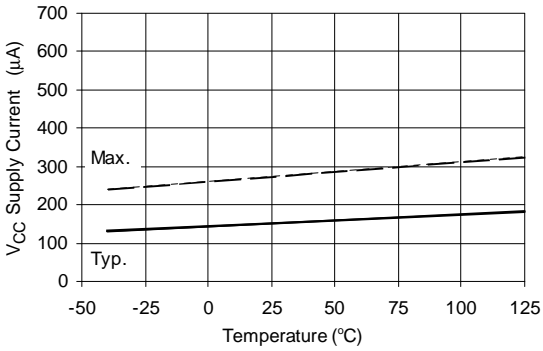
**Figure 13B. Offset Supply Current vs. Voltage**



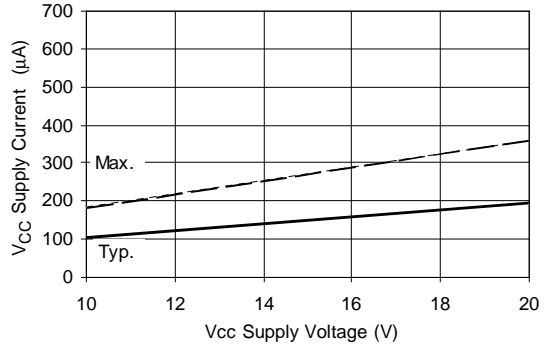
**Figure 14A. V<sub>BS</sub> Supply Current vs. Temperature**



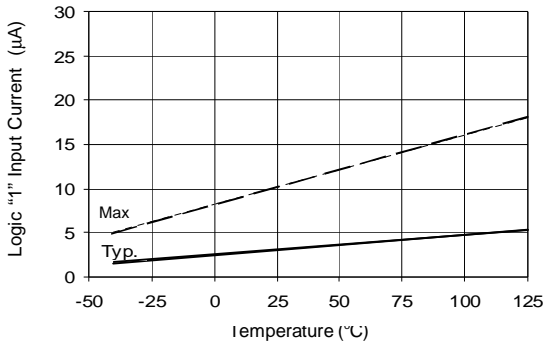
**Figure 14B. V<sub>BS</sub> Supply Current vs. Voltage**



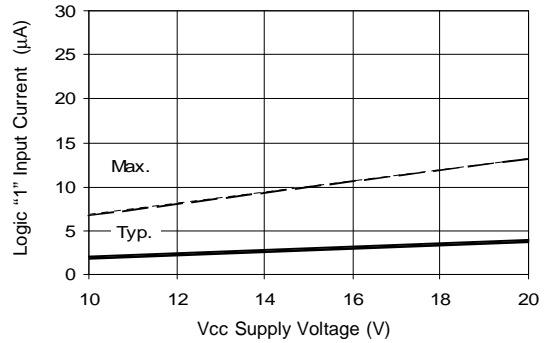
**Figure 15A. V<sub>CC</sub> Supply Current vs. Temperature**



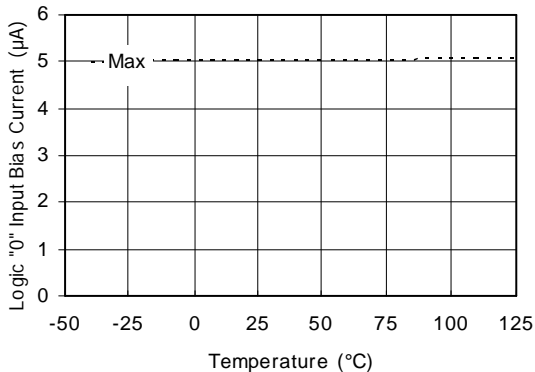
**Figure 15B. V<sub>CC</sub> Supply Current vs. Voltage**



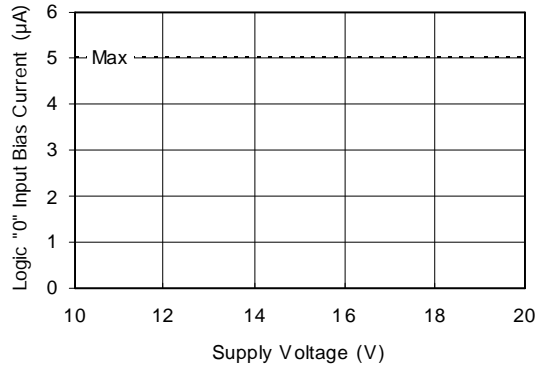
**Figure 16A. Logic "1" Input Current vs. Temperature**



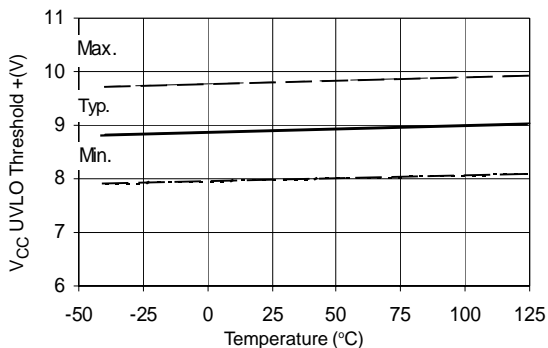
**Figure 16B. Logic "1" Input Current vs. Voltage**



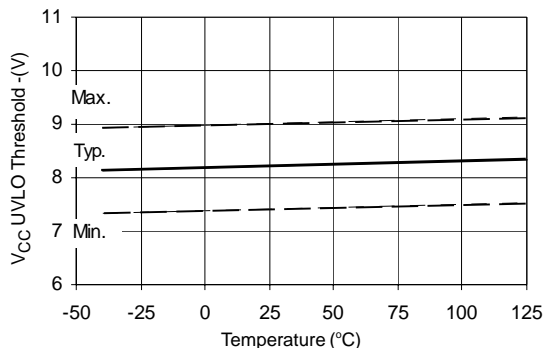
**Figure 17A. Logic "0" Input Current vs. Temperature**



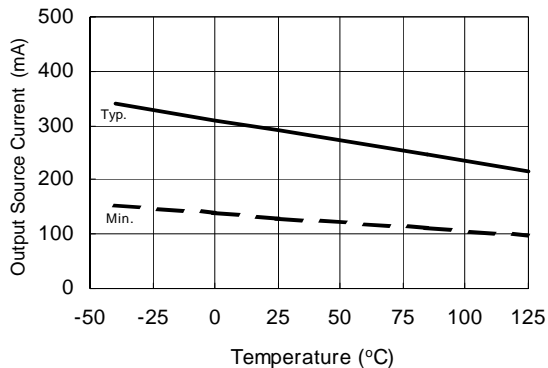
**Figure 17B. Logic "0" Input Current vs. Voltage**



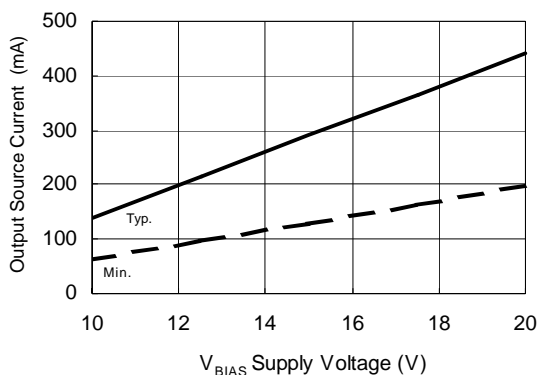
**Figure 18A.  $V_{CC}$  Undervoltage Threshold(+) vs. Temperature**



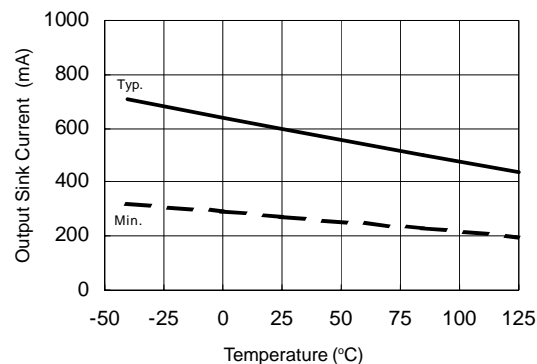
**Figure 18B.  $V_{CC}$  Undervoltage Threshold(-) vs. Temperature**



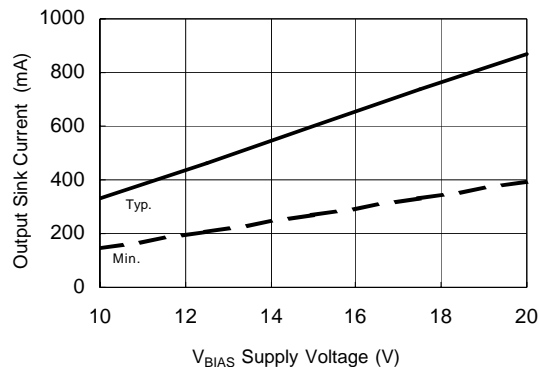
**Figure 19A. Output Source Current vs. Temperature**



**Figure 19B. Output Source Current vs. Supply Voltage**

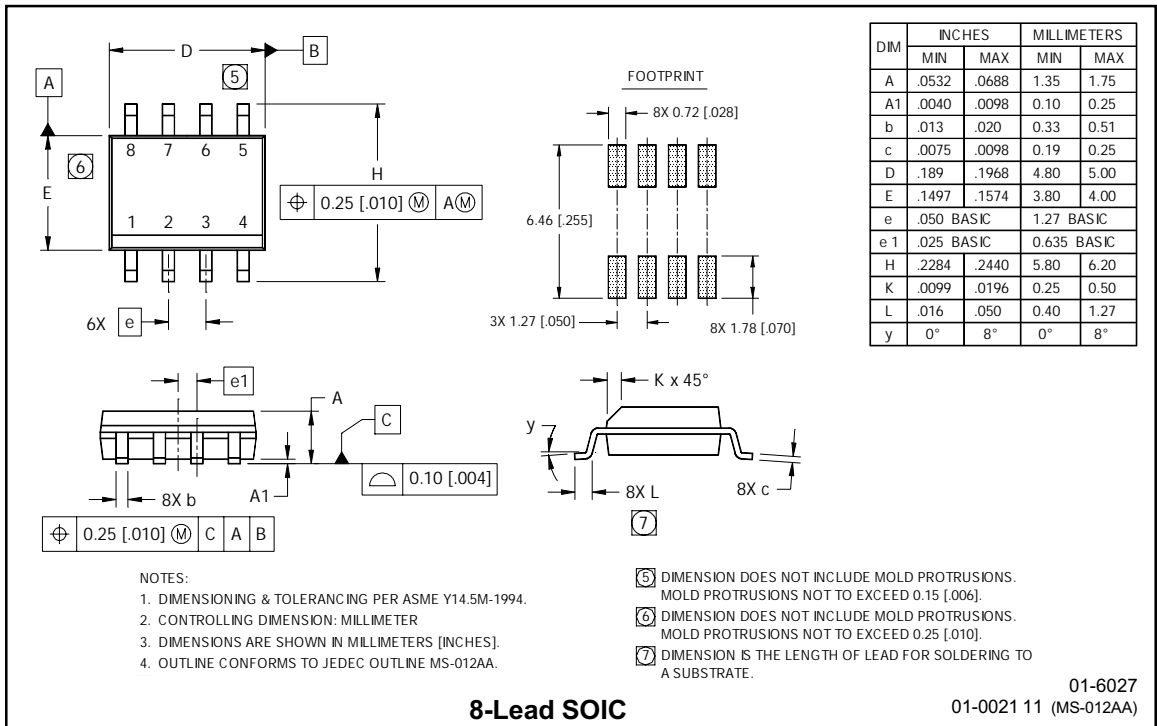
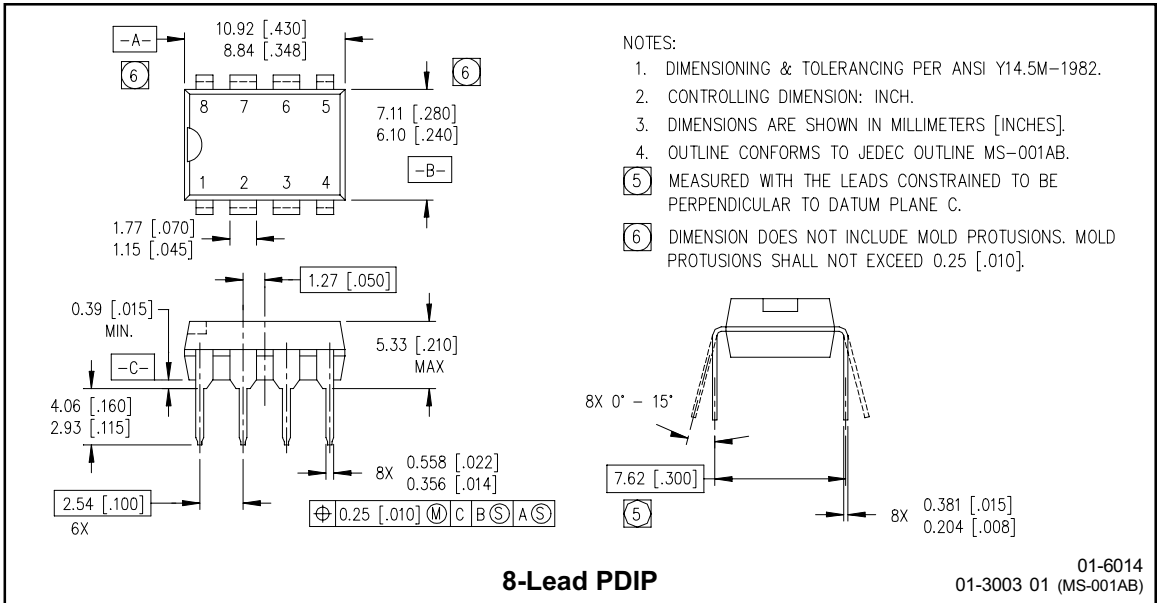


**Figure 20A. Output Sink Current vs. Temperature**

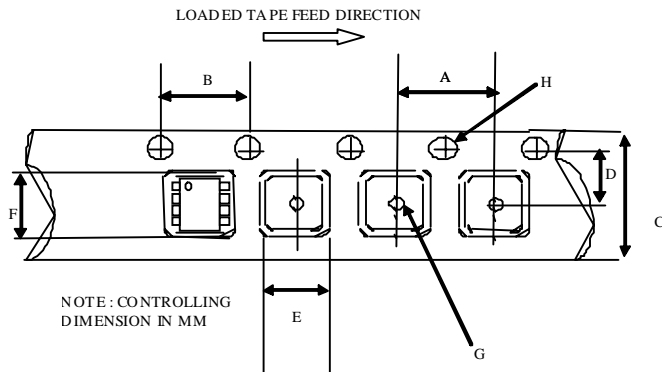


**Figure 20B. Output Sink Current vs. Supply Voltage**

## Case Outlines

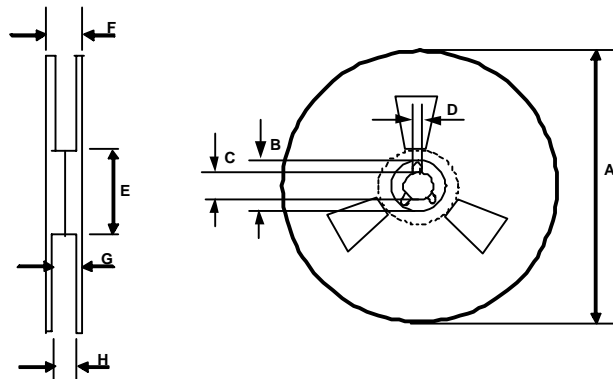


## Tape & Reel 8-lead SOIC



CARRIER TAPE DIMENSION FOR 8SOICN

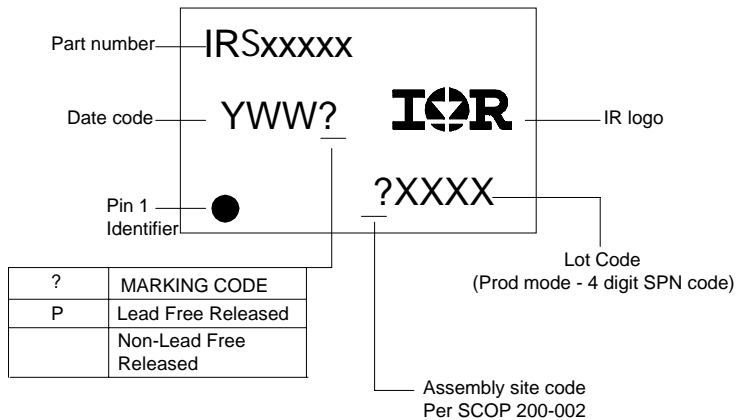
Code	Metric		Imperial	
	Min	Max	Min	Max
A	7.90	8.10	0.311	0.318
B	3.90	4.10	0.153	0.161
C	11.70	12.30	0.46	0.484
D	5.45	5.55	0.214	0.218
E	6.30	6.50	0.248	0.255
F	5.10	5.30	0.200	0.208
G	1.50	n/a	0.059	n/a
H	1.50	1.60	0.059	0.062



REEL DIMENSIONS FOR 8SOICN

Code	Metric		Imperial	
	Min	Max	Min	Max
A	329.60	330.25	12.976	13.001
B	20.95	21.45	0.824	0.844
C	12.80	13.20	0.503	0.519
D	1.95	2.45	0.767	0.096
E	98.00	102.00	3.858	4.015
F	n/a	18.40	n/a	0.724
G	14.50	17.10	0.570	0.673
H	12.40	14.40	0.488	0.566

## LEADFREE PART MARKING INFORMATION



## ORDER INFORMATION

8-Lead PDIP IRS2103PbF  
 8-Lead SOIC IRS2103SPbF  
 8-Lead SOIC Tape & Reel IRS2103STRPbF