

KEY FEATURES

- Switching Power Module for PCB Mountable
- Fully Encapsulated Plastic Case
- Universal Input Range 90-264VAC, 47-440 Hz
- Regulated Output
- Low Ripple and Noise
- CE, UL Approval
- 3-Year Product Warranty



ELECTRICAL SPECIFICATIONS

All specifications valid at normal input voltage, full load and +25°C after warm-up time unless otherwise stated.

Model No. (Single Output)	APC-3.3S-E1	APC-5S-E1	APC-12S-E1	APC-15S-E1	APC-24S-E1	
Max Output Wattage (W)	5W	5W	5W	5W	5W	
Input	Voltage					
	90-264 VAC or 120-370 VDC					
	Frequency (Hz)					
	47-440 Hz					
	Current (Full load)					
	120 mA max. (115 VAC) / 70 mA max. (230 VAC)					
Inrush Current (<2ms)						
23 A max. (115 VAC) / 46 A max. (230 VAC)						
Leakage Current						
0.75 mA max.						
External Fuse (recommend)						
1.5 A slow blow type						
Output	Voltage (V.DC.)	3.3V	5V	12V	15V	24V
	Voltage Accuracy	±2%				
	Current (mA) max	1500	1000	416	333	200
	Line Regulation (LL-HL) (typ.)	±0.3%				
	Load Regulation (5-100%) (typ.)	±0.5%				
	Minimum Load	4%	1%			
	Maximum Capacitive Load	40000 uF	19000 uF	4000 uF	3500 uF	900 uF
	Ripple	<0.2% Vout +40mV max (Vp-p)				
	Noise	<0.5% Vout +50mV max (Vp-p)				
	Efficiency	63%	71%	75%	75%	74%
	Hold-up Time	15 ms min.				
Protection	Over Power Protection	Hiccup technique, auto-recovery				
	Over Voltage Protection	Zener diode clamp				
	Short Circuit Protection	Hiccup mode, indefinite (automatic recovery)				
Isolation	Input-Output (V.AC)	3000V				
	Input-FG (V.AC)	1500V				
	Output-FG (V.AC)	500V				
Environment	Operating Temperature	-40°C...+70°C (with derating)				
	Storage Temperature	-40°C...+85°C				
	Temperature Coefficient	±0.02%/°C				
	Humidity	95% RH				
	MTBF	>300,000 h @ 25°C (MIL-HDBK-217F)				
Physical	Dimension (L x W x H)	2.15 x 1.77 x 0.82 Inches (54.7 x 44.9 x 21.0 mm) Tolerance ±0.5 mm				
	Case Material	Plastic resin (flammability to UL 94V-0)				
	Weight	80 g				
	Cooling Method	Free air convection				
Safety	Agency Approvals	UL/cUL, CE				
EMC	EMI (Conducted & Radiated Emission)	EN 55022 class B				
	EMS (Noise Immunity)	EN 50082-1				

ELECTRICAL SPECIFICATIONS

All specifications valid at normal input voltage, full load and +25°C after warm-up time unless otherwise stated.

Model No. (Dual Output)	APC-5D-E1	APC-12D-E1	APC-15D-E1	
Max Output Wattage (W)	5W	5W	5W	
Input	Voltage			
	90-264 VAC or 120-370 VDC			
	Frequency (Hz)			
	47-440 Hz			
	Current (Full load)			
	120 mA max. (115 VAC) / 70 mA max. (230 VAC)			
Inrush Current (<2ms)				
23 A max. (115 VAC) / 46 A max. (230 VAC)				
Leakage Current				
0.75 mA max.				
External Fuse (recommend)				
1.5 A slow blow type				
Output	Voltage (V.DC.)	±5V	±12V	±15V
	Voltage Accuracy	±2%		
	Current (mA) max	±500	±200	±160
	Line Regulation (LL-HL) (typ.)	±0.3%		
	Load Regulation (5-100%) (typ.)	±0.5%		
	Minimum Load	0%	0%	3%
	Maximum Capacitive Load	±9500 uF	±1400 uF	±950 uF
	Ripple	<0.2% Vout +40mV max (Vp-p)		
	Noise	<0.5% Vout +50mV max (Vp-p)		
	Efficiency	72%	74%	74%
	Hold-up Time	15 ms min.		
Protection	Over Power Protection	Hiccup technique, auto-recovery		
	Over Voltage Protection	Zener diode clamp		
	Short Circuit Protection	Hiccup mode, indefinite (automatic recovery)		
Isolation	Input-Output (V.AC)	3000V		
	Input-FG (V.AC)	1500V		
	Output-FG (V.AC)	500V		
Environment	Operating Temperature	-40°C...+70°C (with derating)		
	Storage Temperature	-40°C...+85°C		
	Temperature Coefficient	±0.02%/°C		
	Humidity	95% RH		
	MTBF	>300,000 h @ 25°C (MIL-HDBK-217F)		
Physical	Dimension (L x W x H)	2.15 x 1.77 x 0.82 Inches (54.7 x 44.9 x 21.0 mm) Tolerance ±0.5 mm		
	Case Material	Plastic resin (flammability to UL 94V-0)		
	Weight	80 g		
	Cooling Method	Free air convection		
Safety	Agency Approvals	UL/cUL, CE		
EMC	EMI (Conducted & Radiated Emission)	EN 55022 class B		
	EMS (Noise Immunity)	EN 50082-1		

NOTE

1. Ripple & Noise are measured at 20MHz of bandwidth with 0.1uF & 47uF parallel capacitor.
2. It's recommended to add Varistor 14S471K at L / N input side in parallel.
3. Please refer to our PDF file "AC-DC Application" on our website: www.archcorp.com.tw

MECHANICAL DIMENSION (Top View)

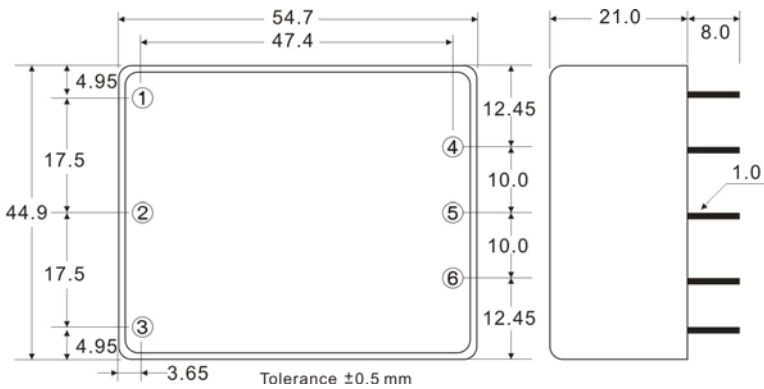

PIN#	Single	Dual
1	FG	FG
2	AC IN (N)	AC IN (N)
3	AC IN (L)	AC IN (L)
4	-DC OUT	-DC OUT
5	NO PIN	COMMON
6	+DC OUT	+DC OUT

BLOCK DIAGRAM

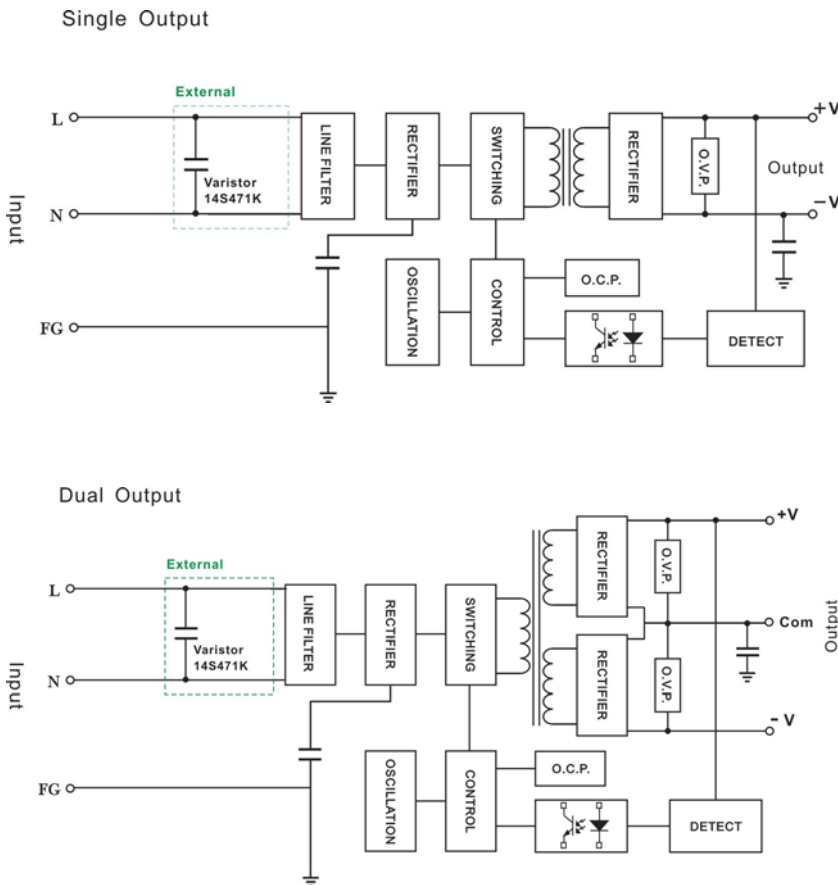

DERATING

