

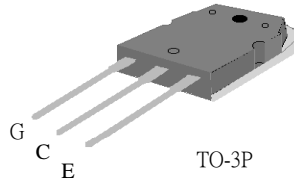

Features

- ▼ High speed switching
- ▼ Low Saturation Voltage
 $V_{CE(sat)}=3.0V @ I_C=30A$
- ▼ Industry Standard TO-3P Package
- ▼ RoHS Compliant



V_{CES}	1000V
I_C	30A

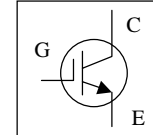

Absolute Maximum Ratings

Symbol	Parameter	Rating	Units
V_{CES}	Collector-Emitter Voltage	1000	V
V_{GE}	Gate-Emitter Voltage	± 30	V
$I_C @ T_C=25^\circ C$	Continuous Collector Current	60	A
$I_C @ T_C=100^\circ C$	Continuous Collector Current	30	A
I_{CM}	Pulsed Collector Current ¹	120	A
$P_D @ T_C=25^\circ C$	Maximum Power Dissipation	208	W
T_{STG}	Storage Temperature Range	-55 to 150	$^\circ C$
T_J	Operating Junction Temperature Range	-55 to 150	$^\circ C$
T_L	Maximum Lead Temp. for Soldering Purposes , 1/8" from case for 5 seconds .	300	$^\circ C$

Notes:

1.Repetitive rating : Pulse width limited by max . junction temperature .

Thermal Data

Symbol	Parameter	Value	Units
Rthj-c	Thermal Resistance Junction-Case	0.6	$^\circ C/W$
Rthj-a	Thermal Resistance Junction-Ambient	40	$^\circ C/W$

Electrical Characteristics @ $T_J=25^\circ C$ (unless otherwise specified)

Symbol	Parameter	Test Conditions	Min.	Typ.	Max.	Units
BV_{CES}	Collect-to-Emitter Breakdown Voltage	$V_{GE}=0V, I_C=250\mu A$	1000	-	-	V
I_{GES}	Gate-to-Emitter Leakage Current	$V_{GE}=\pm 30V, V_{CE}=0V$	-	-	± 500	nA
I_{CES}	Collector-Emitter Leakage Current	$V_{CE}=1000V, V_{GE}=0V$	-	-	1	mA
$V_{CE(sat)}$	Collector-Emitter Saturation Voltage	$V_{GE}=15V, I_C=30A$	-	3	3.6	V
		$V_{GE}=15V, I_C=60A$	-	3.8	-	V
$V_{GE(th)}$	Gate Threshold Voltage	$V_{CE}=V_{GE}, I_C=1mA$	3	4.4	7	V
Q_g	Total Gate Charge	$I_C=30A$	-	55	88	nC
Q_{ge}	Gate-Emitter Charge	$V_{CC}=500V$	-	12	-	nC
Q_{gc}	Gate-Collector Charge	$V_{GE}=15V$	-	27	-	nC
$t_{d(on)}$	Turn-on Delay Time	$V_{CC}=500V,$ $I_C=30A,$ $V_{GE}=15V,$ $R_G=5\Omega,$ Inductive Load	-	30	-	ns
t_r	Rise Time		-	40	-	ns
$t_{d(off)}$	Turn-off Delay Time		-	105	-	ns
t_f	Fall Time		-	290	440	ns
E_{on}	Turn-On Switching Loss		-	1.2	-	mJ
E_{off}	Turn-Off Switching Loss		-	1.7	-	mJ
C_{ies}	Input Capacitance	$V_{GE}=0V$	-	1320	2110	pF
C_{oes}	Output Capacitance	$V_{CE}=30V$	-	105	-	pF
C_{res}	Reverse Transfer Capacitance	$f=1.0MHz$	-	9	-	pF

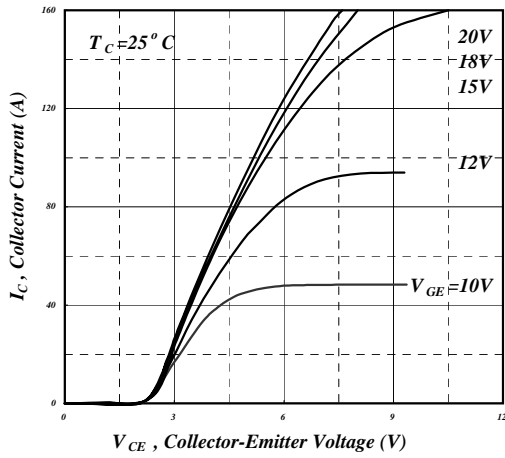

Fig 1. Typical Output Characteristics

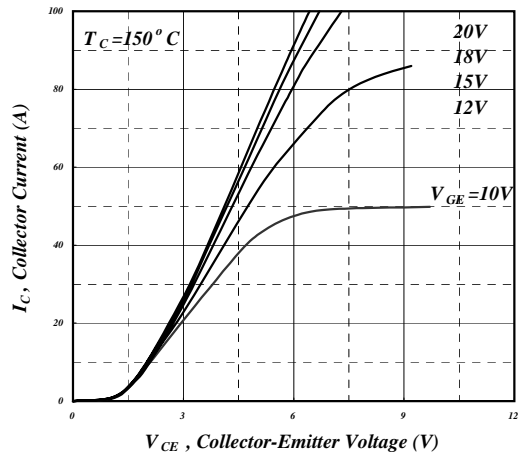

Fig 2. Typical Output Characteristics

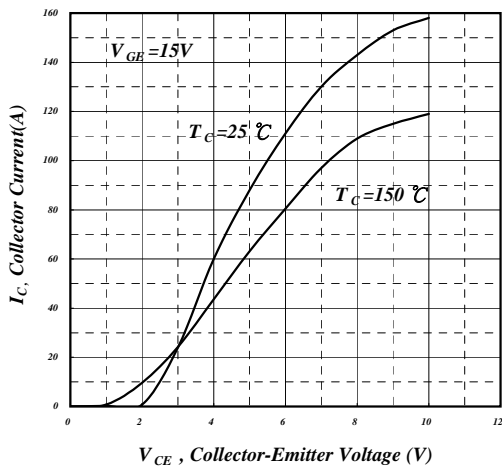

Fig 3. Typical Saturation Voltage Characteristics

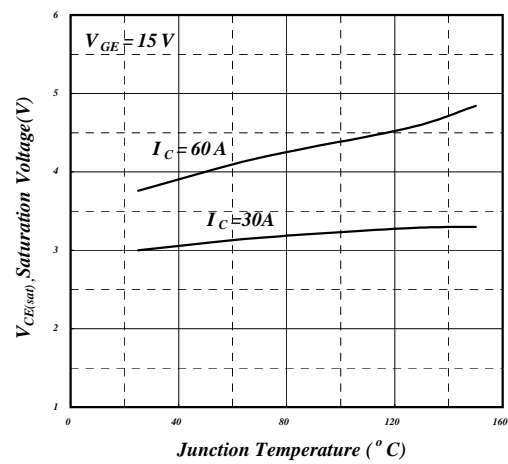

Fig 4. Typical Collector-Emitter Voltage v.s. Junction Temperature

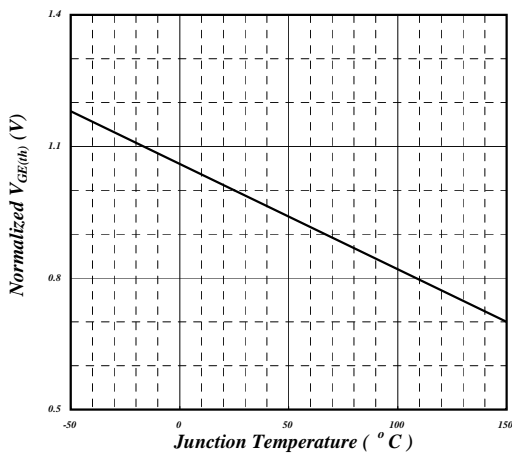

Fig 5. Gate Threshold Voltage v.s. Junction Temperature

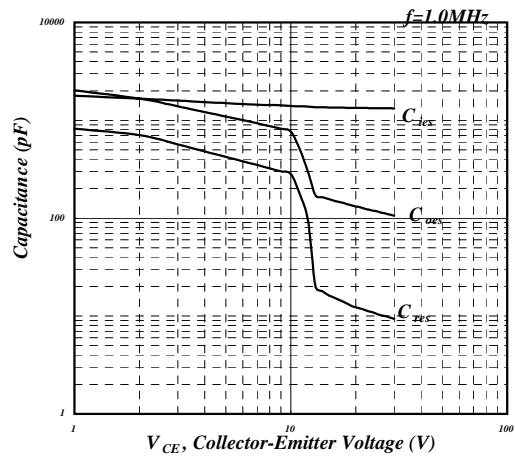

Fig 6. Typical Capacitance Characteristics

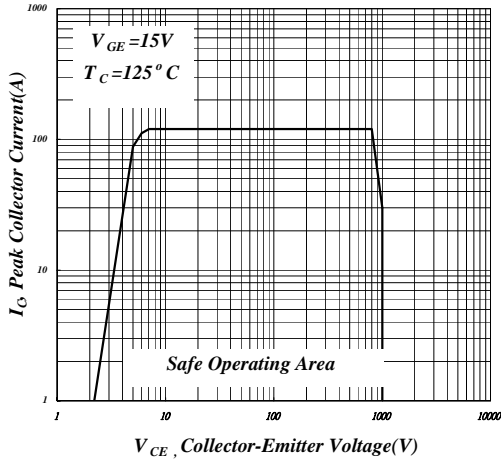

Fig 7. Turn-off SOA

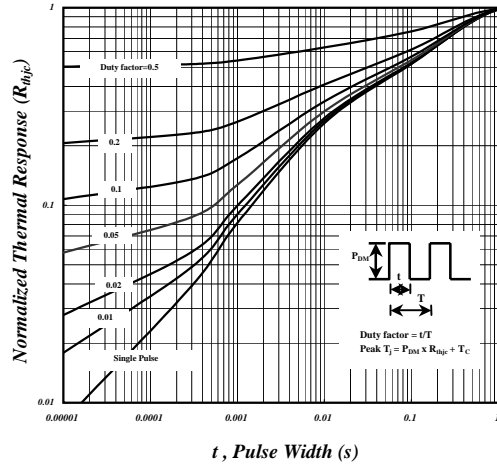

Fig 8. Effective Transient Thermal Impedance

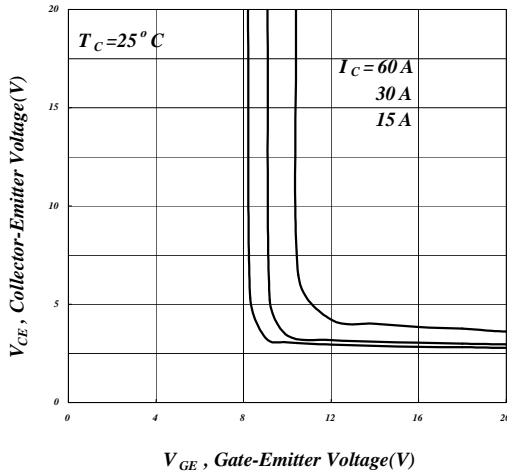

Fig 9. Saturation Voltage vs. V_{GE}

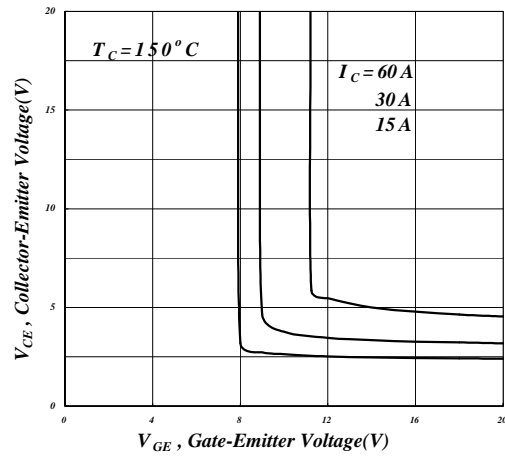

Fig 10. Saturation Voltage vs. V_{GE}

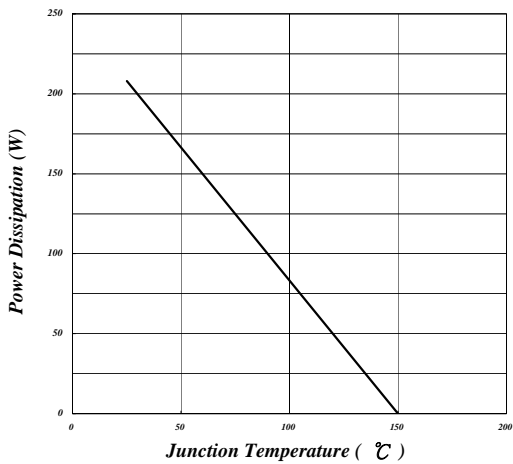

Fig11. Power Dissipation vs. Junction Temperature

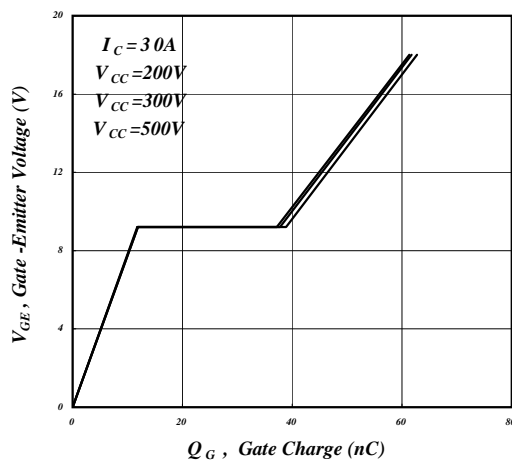
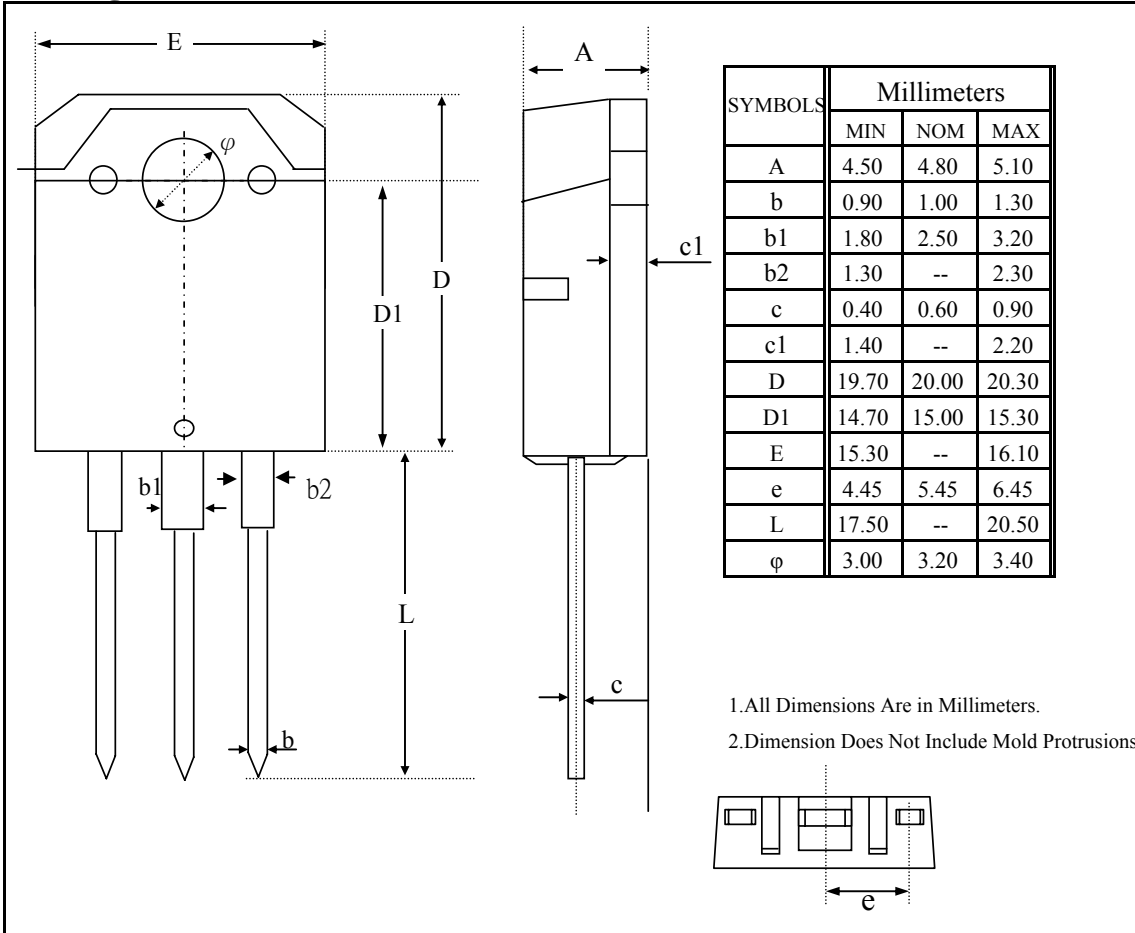

Fig 12. Gate Charge Characteristics



Package Outline : TO-3P



Part Marking Information & Packing : TO-3P

